

Pioneer Dj

AUDIO INTERFACE

INTERFACE 2

[pioneerdj.com/support/
rekordbox.com/](http://pioneerdj.com/support/rekordbox.com/)

The Pioneer DJ site shown above offers FAQs, information on software, and various other types of information and services to allow you to use your product in greater comfort.

Operating Instructions

Contents

How to read this manual

Thank you for buying this Pioneer DJ product.

Be sure to read this manual and the "Operating Instructions (Quick Start Guide)" included with the unit. Both documents include important information that you should understand before using this product.

For the operation of the rekordbox software, refer to the software manual of the rekordbox.

- Please note that the screens and specifications of the software described in this manual as well as the external appearance and specifications of the hardware are currently under development and may differ from the final specifications.
- Please note that depending on the operating system version, web browser settings, etc., operation may differ from the procedures described in this manual.
- Please note that the language on the screens of the software describes in this guide may differ from the language on your screens.

01 Before start

Features	3
What's in the box	3
About the AC adaptor.....	3

02 Part names and functions

Top panel	4
Rear panel	5
Front panel	5
Side panel.....	5

03 Connections

Connecting input/output terminals	6
---	---

04 Using rekordbox

About rekordbox	9
Installing rekordbox.....	9
Starting rekordbox.....	11
Preparing rekordbox.....	11
Adding audio tracks into [Collection]	12

05 Changing the settings

About the setting utility software	13
Checking the latest information on the driver software.....	13

06 Using DVS

About the settings of rekordbox dvs	14
---	----

07 Using an application other than rekordbox

Installing the driver software	15
--------------------------------------	----

08 Additional information

Troubleshooting.....	18
About trademarks and registered trademarks	18
Cautions on copyrights	18

Before start

Features

This unit is a 2-channel audio interface that lets you use rekordbox dvs when combined with an existing mixer. Thanks to professional sound quality ready for on-site use and a portable compact and rugged chassis, DJ performances using DVS will become possible anytime and anywhere. LED indicators on the top panel show sound flow and make it easy to correctly connect on site.

PLUG & PLAY

You can start playing with DJ software immediately by connecting to a computer using a USB cable without having to make complicated settings.

What's in the box

- Power cord
- AC adaptor
- USB cable
- Audio cable × 4
- Rubber feet × 4
- Operating Instructions (Quick Start Guide)
- Warranty (for some regions only)*
- License key card (rekordbox dj, rekordbox dvs)

* Products for Europe only. (The corresponding information is provided on the back cover of "Operating Instructions (Quick Start Guide)" for Japan, and on the last page of both the English and French versions of the "Operating Instructions (Quick Start Guide)" for the North American region.)

Note

Please keep the license key because it cannot be provided again.

About the AC adaptor

Notes on use

- Do not use in dusty or hot and humid places.
- Do not apply vibration or shock.
- Be careful not to allow a foreign object or water to get into the AC adaptor.
- Do not leave the device on an unstable surface or high place. Dropping the AC adaptor may cause injuries.
- Be sure to connect to the specified power supply.
- When moving equipment connected to this AC adapter, disconnect the cord from the AC outlet and remove the external connection cord. Otherwise, the cord may be damaged and cause fire or electric shock.
- Do not check the inside or perform remodeling.
- If unusual noise or smells occur when using the AC adaptor, undergo an inspection after turning off the power.
- Clean the surface of this AC adaptor with a soft cloth. If the staining is severe, dilute neutral detergent with water 5 to 6 times, soak a soft cloth and squeeze it well, wipe off the stains, then wipe it with a dry cloth. Do not use volatile chemicals such as benzine, thinner, alcohol, insecticide, etc. as it may stain the surface. Also, read the attached notes on chemical cloth if you are using chemical cloth, etc.
- If there is a problem with the AC adaptor or power cord, consult the repair reception desk mentioned in the Operating Instructions (Quick Start Guide) or the dealer you purchased the product from.

Part names and functions

Top panel

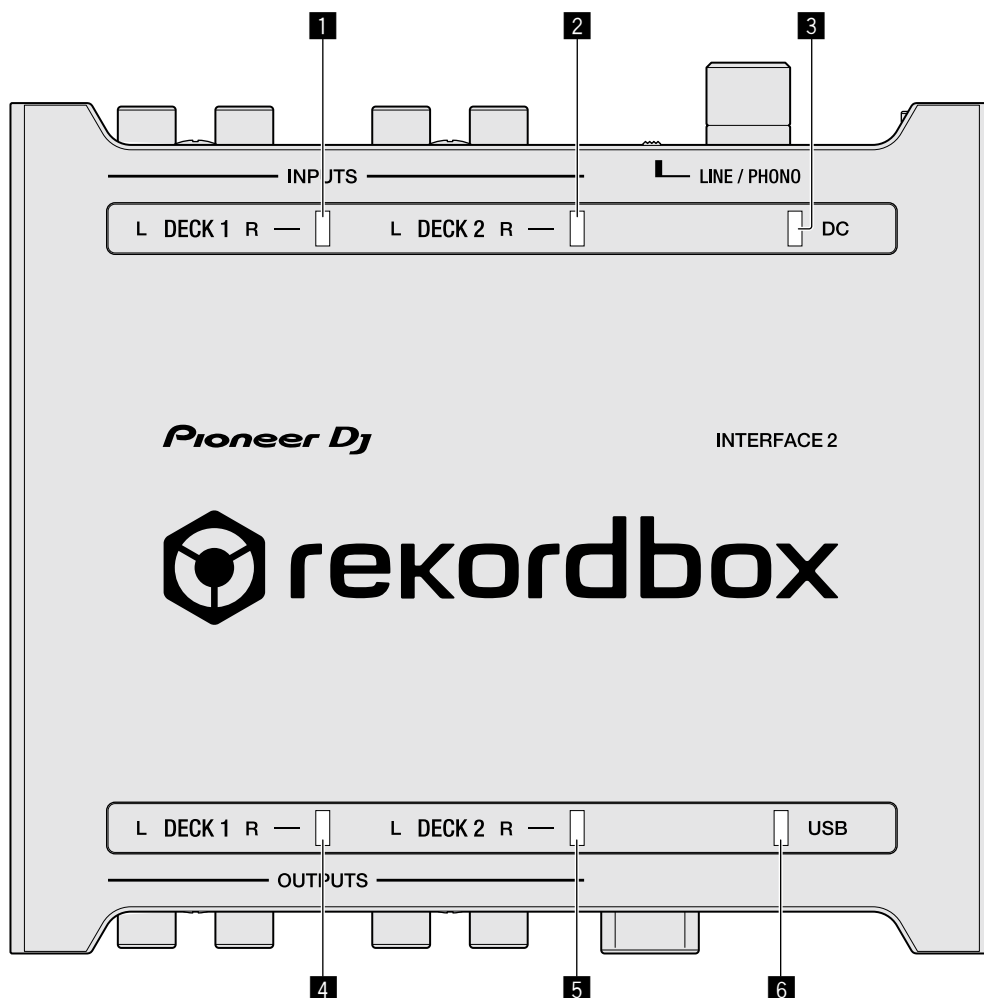

1 DECK1 input indicator

Lights up when sound is input to the DECK1 input terminals.

- Red: Shows that the input level is loud and the sound is distorted.
- Green: Brightness changes in two levels depending on the input level. When only L or R is input, this indicator flashes.

2 DECK2 input indicator

Lights up when sound is input to the DECK2 input terminals.

- Red: Shows that the input level is loud and the sound is distorted.
- Green: Brightness changes in two levels depending on the input level. When only L or R is input, this indicator flashes.

3 DC indicator

Lights up when the DC plug of the supplied AC adaptor is connected.

4 DECK1 output indicator

Shows the DECK1 output level.

- Green: Brightness changes in two levels depending on the output level.

5 DECK2 output indicator

Shows the DECK2 output level.

- Green: Brightness changes in two levels depending on the output level.

6 USB indicator

Lights up when a computer is connected. When the driver software is not installed to a computer, this indicator flashes.

Rear panel

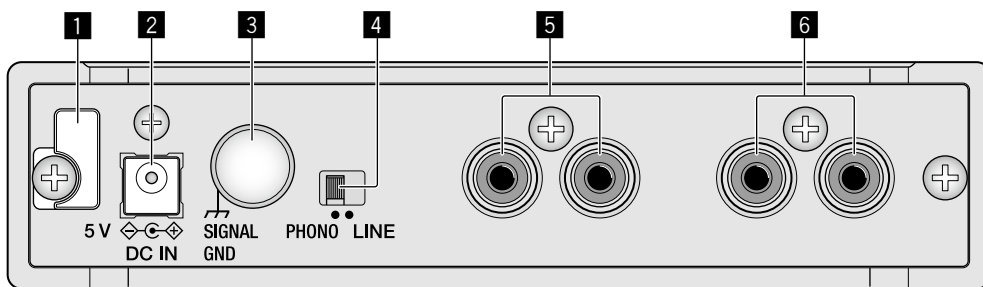

1 Cord hook

Hooks the power cord of the AC adaptor. See "How to use the cord hook/USB cable hook" (page 8).

2 DC IN terminal

Connect the DC plug of the supplied AC adaptor. Only use the power cord and AC adapter supplied with this unit.

3 SIGNAL GND terminal

Connect an analog player's ground wire. This helps reduce noise when the analog player is connected.

4 Input selector switch

Switches the input level of DECK1 or DECK2 input terminals.

- **[LINE]**: Select when connecting a DJ player or line level output component.
- **[PHONO]**: Select when connecting a phono level (MM cartridge) output device. Do not select when connecting a line level output DJ player, etc.

5 DECK2 input terminals

Connects to a DJ player, line level output component or phono level (MM cartridge) output device.

6 DECK1 input terminals

Connects to a DJ player, line level output component or phono level (MM cartridge) output device.

Front panel

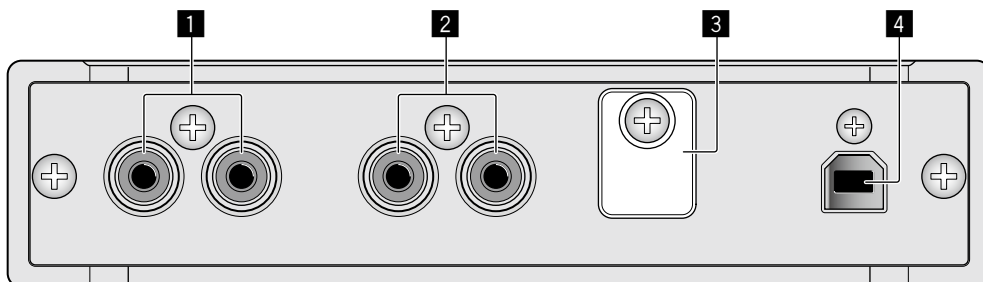

1 DECK1 output terminals

Connects to the line level analog input terminals of a DJ mixer, etc.

2 DECK2 output terminals

Connects to the line level analog input terminals of a DJ mixer, etc.

3 USB cable hook

Hooks the USB cable. See "How to use the cord hook/USB cable hook" (page 8).

4 USB terminal

Connects to a computer.

Side panel

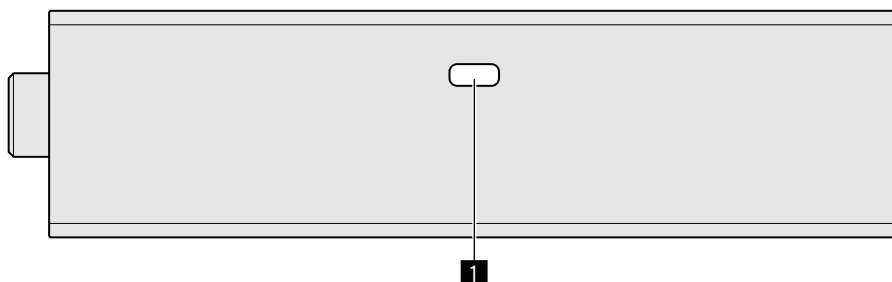

1 Kensington security slot

Attach the wire lock for theft prevention.

Connections

- Connect the power cord after all connections between devices have been completed.
Be sure to remove the USB cable and unplug the power cord from the power outlet whenever making or changing connections.
- Be sure to use the supplied power cord and AC adaptor.
- Power is supplied by the AC adaptor or USB bus power.
- Connect this unit and the computer directly using the supplied USB cable.
- Use USB cables that conform to USB 2.0.
- USB hubs cannot be used.
- When the USB cable is not connected, the input audio is output at the line level from the output terminal.
- Refer to the operating instructions for the device to be connected.

Notes on using the USB bus power

- This unit may not be used with the USB bus power in the following situation.
 - Power supply capacity of the USB port on your computer is too low.
 - Your computer is connected with other USB devices.If the USB bus power cannot be used, use the supplied AC adaptor.
- When using the USB bus power, the brightness of the LEDs decreases.
To use without restriction, use the supplied AC adaptor.

Connecting input/output terminals

Rear panel

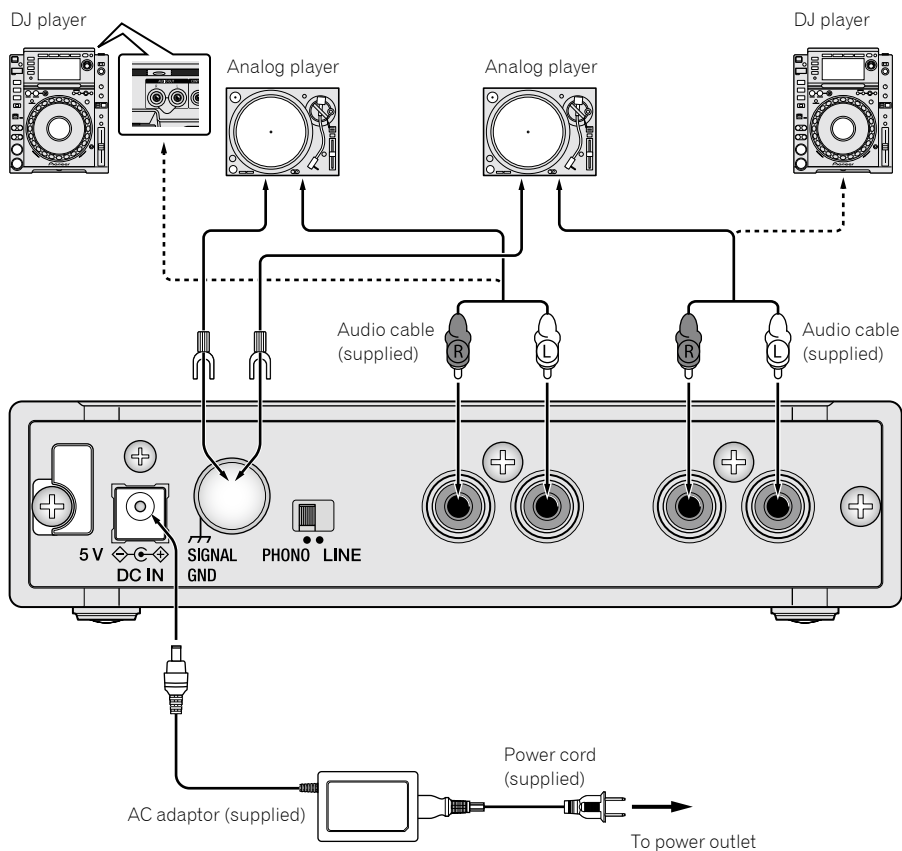

Front panel

Audio will output at line level.

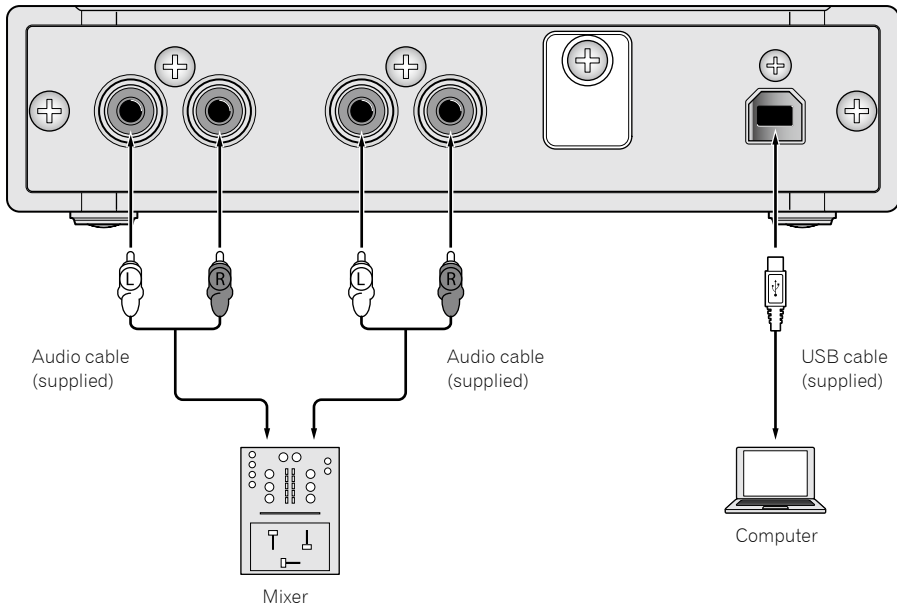

How to attach the rubber feet

Attach the rubber feet to the unit if needed. Depending on where placing the unit, attach the rubber feet accordingly.

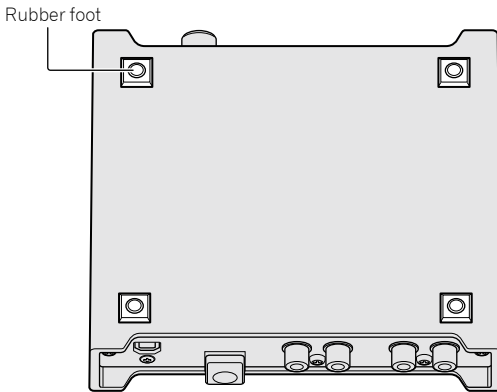

How to use the cord hook/USB cable hook

The power cord of the AC adaptor/USB cable is fixed by hooking to the cord hook/USB cable hook.

Hook the power cord of the AC adaptor/USB cable to avoid accidentally disconnecting them from the unit.

For the position to hook the power cord of the AC adaptor/USB cable, use the width of the unit as a guide.

The power cord of the AC adaptor

- 1 Connect the power cord of the AC adaptor to the [DC IN] terminal.
- 2 Fix the position to hook the power cord of the AC adaptor.

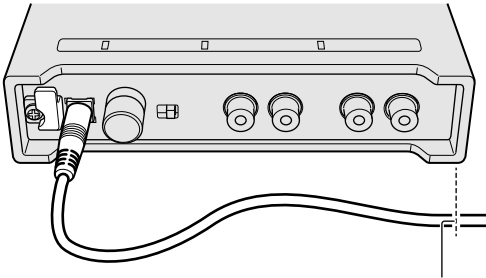

The position to hook the power cord of the AC adaptor

- 3 Hook the power cord of the AC adaptor from above.

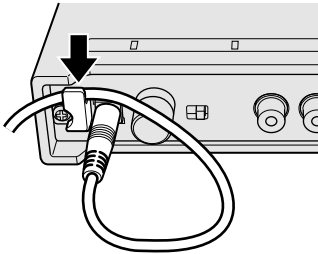

- 4 Make sure to hook the power cord of the AC adaptor securely.

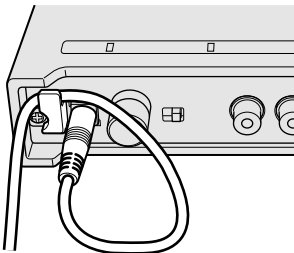

The USB cable

- 1 Connect the USB cable to the [USB] port.
- 2 Fix the position to hook the USB cable.

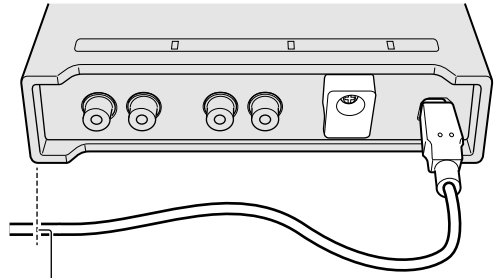

The position to hook the USB cable

- 3 Hook the USB cable from below.

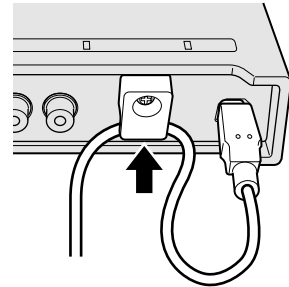

- 4 Make sure to hook the USB cable securely.

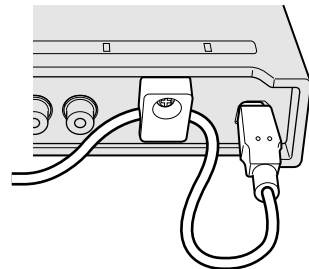

Using rekordbox

About rekordbox

This manual mainly explains the hardware operations of this unit. For detailed instructions on operating rekordbox dj and rekordbox dvs, see the rekordbox Manual.

- rekordbox
rekordbox is composite software that enables track management and DJ performances.
- rekordbox dj
The DJ performance function of rekordbox is called rekordbox dj. To be able to use this function, enter the license key shown on the license key card included with this unit.
- rekordbox dvs
The DVS function, which can be added to rekordbox dj to perform deck operations using control signals played with CDJ or a turntable, is called rekordbox dvs. To add this function, enter the license key shown on the license key card included with this unit.

Minimum operating environment

Supported operating systems CPU and required memory

macOS Sierra 10.12 (latest updated) OS X: 10.11/10.10/10.9 (latest updated)	Intel® processor Core™ i3/i5/i7, Intel® processor Core™ 2 Duo 4 GB or more of RAM
Windows: Windows 10/Windows 8.1/ Windows 7 (latest service pack)	Intel® processor Core™ i3/i5/i7, Intel® processor Core™ 2 Duo 4 GB or more of RAM

Others

USB port	A USB 2.0 port is required to connect the computer with this unit.
Display resolution	Resolution of 1 280 x 768 or greater
Internet connection	An Internet connection is required for registering the rekordbox user account and downloading the software.

- For information on the latest system requirements, compatibility, and supported operating systems of rekordbox, see [System Requirements] on the rekordbox.com site below.
rekordbox.com/
- Operation is not guaranteed on all computers, even if all the required operating environment conditions indicated here are fulfilled.
- Depending on the computer's power-saving settings, etc., the CPU and hard disk may not provide sufficient processing capabilities. For notebook computers in particular, make sure the computer is in the proper conditions to provide constant high performance (for example by keeping the AC power connected) when using rekordbox.
- Use of the Internet requires a separate contract with a provider offering Internet services and payment of provider fees.
- Operating System support assumes you are using the latest point release for that version.

Viewing the "rekordbox" manual

A manual may be made of the PDF format file. To view a PDF file, installing Adobe® Reader® is required.

1 Launch a web browser on the computer and access the "rekordbox.com".

rekordbox.com/

2 Click [Support].

3 Click [Manual].

4 Click the desired language from the list.

- For information and services for "rekordbox," refer to the "rekordbox.com" above.

Installing rekordbox

If you are installing rekordbox for the first time or are upgrading from rekordbox 3 or earlier, use the following procedures.

If you have installed rekordbox 4 already, update it to the latest version.

Before installing the software

The rekordbox software is not included.

Access "rekordbox.com" for the rekordbox software, and download the software.

rekordbox.com/

- The user is responsible for preparing the computer, network devices and other elements of the Internet usage environment required for a connection to the Internet.
- If you have installed rekordbox 4 already, update it to the latest version to use rekordbox dj and rekordbox dvs.

Downloading rekordbox

1 Access "rekordbox.com".

rekordbox.com/en/store/

- The site is subject to change without notice.

2 After reading the Get Started guide, click [Free To Download].



3 Read the terms of the software license agreement carefully, and then mark the [Agree] checkbox to continue.

After marking the checkbox, click [Download] to start downloading rekordbox.

4 Click [Download].

Downloading rekordbox will be started.

Installing rekordbox

Depending on the Operating System (OS) of your computer, procedures differ.

Do not connect the unit to your computer until the installation has completed.

- If a program is opened on your computer, close it.

Installing (Mac)

- 1 Unzip the downloaded rekordbox software file.
- 2 Double-click the unzipped software file, and then start the installer.
- 3 Read the terms of the license agreement carefully, and then click [Agree] to continue.

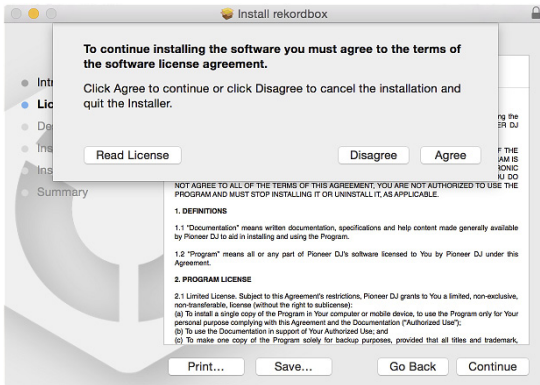

- If you do not agree to the contents of the license agreement, click [Disagree] to cancel the installation.

- 4 When the screen for completing the installation appears, click [Close] to end the installation.

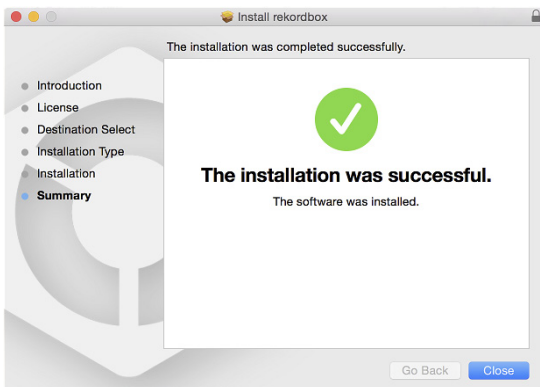

Installing (Windows)

- Log into your computer as administrator before starting the installation.

- 1 Unzip the downloaded rekordbox software file.
- 2 Double-click the unzipped software file, and then start the installer.

- 3 Read the terms of the license agreement carefully, and if you agree, select [Agree], then click [Next].

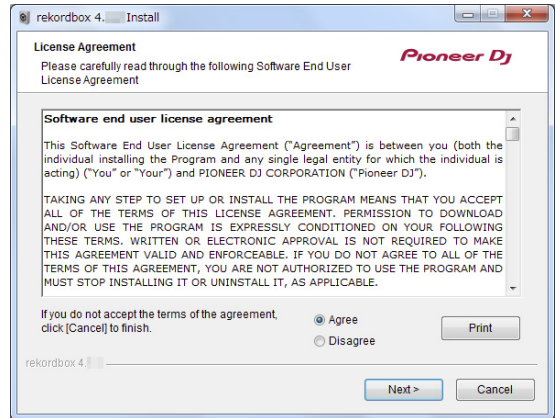

- If you do not agree to the contents of the license agreement, click [Cancel] to cancel the installation.

After specifying the destination, the installation will be started. When the installation is finished, a completion message will be displayed.

- 4 Click [Finish] to complete the installation.

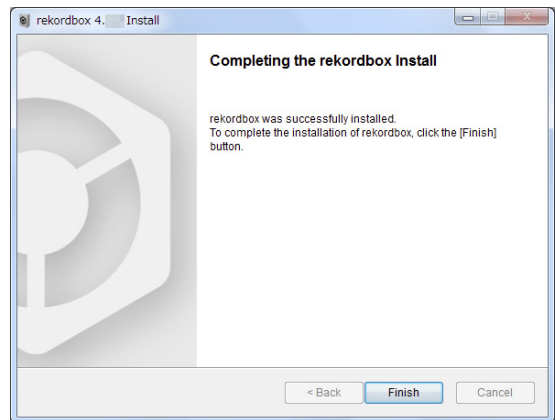

Starting rekordbox

Click the [rekordbox] icon.

For Mac

In Finder, open the [Applications] folder, and then click the [rekordbox] icon in the [rekordbox 4] folder.

For Windows 10/8.1

In [Apps view], click the [rekordbox] icon.

For Windows 7

In the Windows [Start] menu, click the [rekordbox] icon under [All Programs] > [Pioneer] > [rekordbox X.X.X] > [rekordbox].

Preparing rekordbox

- This procedure is required only for the first time to start the rekordbox.

Enter the account information.

If you have an account already, enter the account information, and then click [Setup].

If you do not have an account, click [Create an account] to create an account.

- For the procedure to create an account, access "rekordbox.com", and read the rekordbox Manual on the [Support] > [Manual] page. rekordbox.com/

The screenshot shows the rekordbox account management interface. At the top, it says "rekordbox" and "In order to use rekordbox, you need to create and setup an account in rekordbox. If you have a KJVO account, please use it." Below this, there are two sections: "If you have an account," which includes fields for "Email address" and "Password" with a "Setup" button, and "If you do not have an account," which includes a "Create an account" button. There are also links for "Forgot Your password?" and "You are not connected to the Internet?".

Choose the method you will use.

Click [DJ performance] icon.

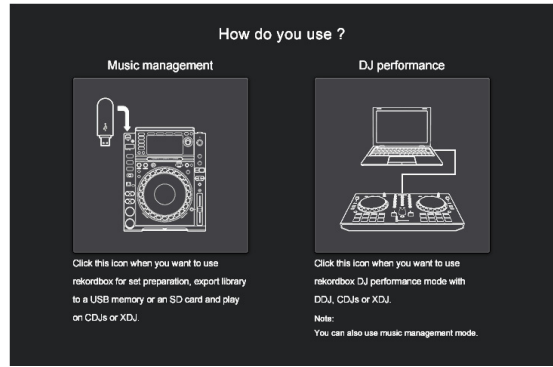

Enter the license key to activate rekordbox dj.

Enter the license keys which are shown on the license key card included with this unit, then follow the screen instructions to activate rekordbox dj and rekordbox dvs.

- For the procedure to activate rekordbox dj, access "rekordbox.com", and read the rekordbox Manual on the [Support] > [Manual] page. rekordbox.com/
- Set rekordbox to [PERFORMANCE].
- Click [Activate] under [Preferences] > [License] > [rekordbox dj], [rekordbox dvs].

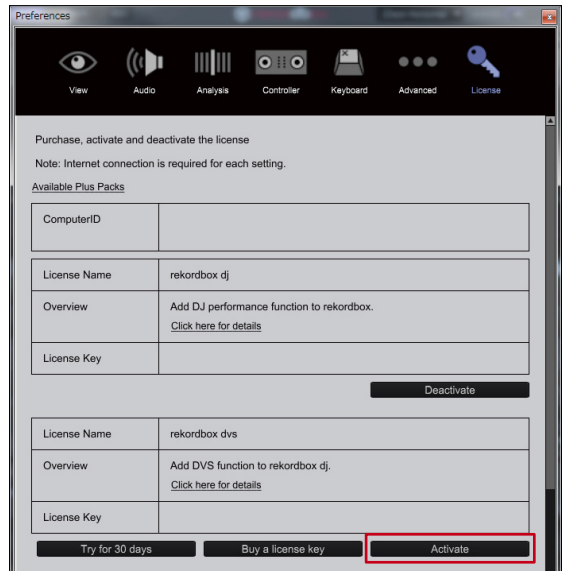

- Enter the supplied rekordbox dj, rekordbox dvs license key.

The screenshot shows the "rekordbox dvs" license key entry screen. It says "Enter a license key of rekordbox dvs." and "To purchase a license key, click here". There is a text input field labeled "rekordbox account name" with a red box around it. At the bottom, there are "OK" and "Cancel" buttons.

- You can use the DVS function with rekordbox (PERFORMANCE mode).

Installing the driver software

This audio driver software is for output sound of the computer from this unit.

- 1 **Disconnect the USB cable connected between the unit and computer.**
- 2 **On the [Audio Driver Install] screen, select [INTERFACE2] from the pull down menu, and then click [Install].**



- If you click **[Skip]**, the audio driver is not installed. To install the audio driver later, select the following file after clicking **[Preferences] > [Audio] > [Audio] > [Driver]** on rekordbox dj.
For Mac: INTERFACE2_M_X.X.X.dmg
For Windows: INTERFACE2_X.XXX.exe

Installing (Mac)

Do not connect the unit and computer until the installing is completed.

- If a program is opened on your computer, close it.
- 1 **Read the instruction screen, and then click [Continue].**
 - 2 **Read the terms of the software license agreement carefully, and then click [Continue].**
If you do not agree to the contents of the license agreement, click **[Disagree]** to cancel the installation.
 - 3 **Follow the instruction screens to install the software.**
 - 4 **Connect the unit and your computer with using the USB cable.**

Installing (Windows)

Do not connect the unit and computer until the installing is completed.

- Logon into your computer as administrator before starting the installation.
 - If a program is opened on your computer, close it.
- 1 **Read the instruction screen, and then click [Continue].**
 - 2 **Read the terms of the software license agreement carefully, mark the [I agree] checkbox, and then click [OK].**
If you do not agree to the contents of the license agreement, click **[Cancel]** to cancel the installation.

- 3 **Follow the instruction screens to install the software.**

If the **[Windows Security]** screen is displayed during the installation, click **[Install this driver software anyway]** to continue.

When the installation is finished, a completion message will be displayed.

- 4 **Connect the unit and your computer with using the USB cable.**

Adding audio tracks into [Collection]

The **[Collection]** screen contains a list of audio track files managed by rekordbox.

Register audio tracks on your computer to rekordbox, and analyze them so they can be used on rekordbox.

- 1 **Click [Collection] on the tree view.**
An audio track list registered on **[Collection]** is displayed.
- 2 **Open Finder or Windows Explorer, and then drag & drop audio track files or folders with audio track files into the audio track list.**

Audio track files are added into **[Collection]**, and then analyzing of waveform information for audio track files starts.

Wait until analyzing of all audio track files is completed.

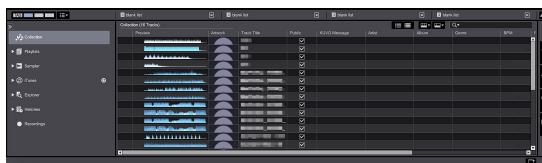

Changing the settings

About the setting utility software

The setting utility can be used to make the checks and settings described below.

- Set the audio data output from this unit.
- Adjust the buffer size (when using Windows ASIO).
- Check the version of the firmware and driver software.

Displaying the setting utility

For Mac

Click [Macintosh HD] icon > [Application] > [Pioneer] > [INTERFACE2] > [INTERFACE2 Settings Utility].

For Windows 10/8.1

In [Apps view], click the [INTERFACE2 Settings Utility] icon.

For Windows 7

Click [Start] menu > [All Programs] > [Pioneer] > [INTERFACE2] > [INTERFACE2 Settings Utility].

Setting the audio data output from this unit

Display the setting utility before starting.

1 Click the [ROUTING] tab.

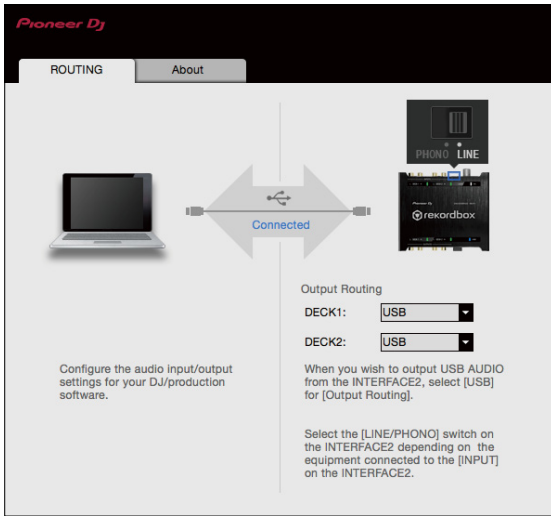

2 Click the [Output Routing] pull-down menu.

Set the audio data output from this unit.

- [USB]: output the audio data input from the computer.
- [THRU]: output the audio data input from the input terminal on this unit.

Adjusting the buffer size (when using Windows ASIO)

If an application using this unit as the default audio device (DJ software, etc.) is running, quit that application before adjusting the buffer size.

Display the setting utility before starting.

Click the [ASIO] tab.

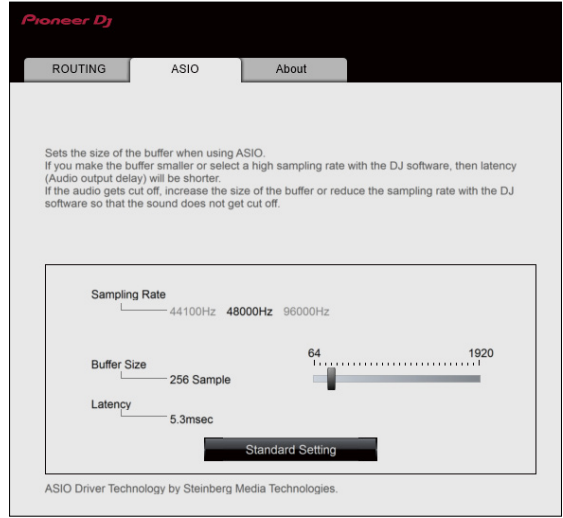

- If the buffer size is made large, drops in audio data (breaks in the sound) occur less easily, but the time lag due to the delay in the transfer of the audio data (latency) increases.

Checking the version of the firmware and driver software

Display the setting utility before starting.

Click the [About] tab.

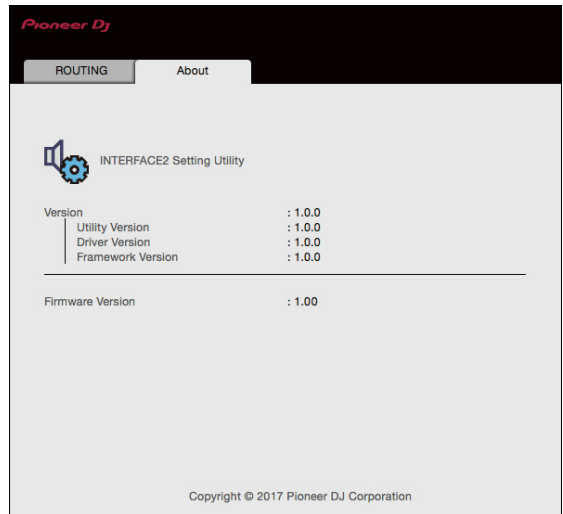

Checking the latest information on the driver software

For the latest information on this unit's dedicated driver software, see the Pioneer DJ site below.

pioneerdj.com/support/

- Operation cannot be guaranteed when multiple units of this unit are connected to a single computer.

Using DVS

Digital music files on a computer can be played by connecting the computer ^[1] and an analog player (or DJ player) to this unit and then playing a control disc ^[2] with the analog player (or DJ player).

[1] Install rekordbox DVS on your computer beforehand.

[2] A special record or CD containing the signals necessary for operating digital music files.

About the settings of rekordbox dvs

For the settings of rekordbox dvs to use the DVS system, refer to *rekordbox dvs Setup Guide* on the following web site.
rekordbox.com/en/support/manual.php

Setting DVS with rekordbox

Performing the following setting on rekordbox (PERFORMANCE mode) of [Preferences] > [DVS].

1 Enable/Disable the DVS function.

2 Set the control signal.



ABS: ABSOLUTE mode

- Location of the needle on the turn table is linked with the playback position of rekordbox DECK.

REL: RELATIVE mode

- Location of the needle on the turn table is not linked with the playback position of rekordbox DECK.

INT: INTERNAL mode

- Location of the needle, playback direction, tempo, and Vinyl operation on the turn table are not linked to the playback of DECK.

THR: THROUGH mode

- The playback sound of the turn table is output as it is.

About [Enable DVS Function]

When putting a check mark in [Enable DVS Function], each DECK switches the DVS mode.

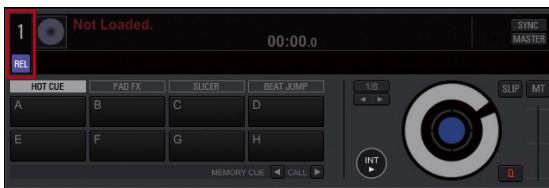

There are four kinds of DVS modes ABSOLUTE, RELATIVE, INTERNAL, THROUGH.

Click the DECK number **1** to select the mode from the menu.

When selecting the mode, the selected mode name (**ABS** **REL** **INT** **THR**) appears under the DECK number.

The mode name lights up when receiving the control signal from the turn table (or CDJ, XDJ).

When receiving the control signal: **REL**

When receiving no control signal: **REL**

Using an application other than rekordbox

Installing the driver software

This driver software is a proprietary program for inputting and outputting audio signals from the computer. To use this unit connected to a computer on which a Mac OS or Windows is installed, install the driver software on the computer beforehand.

Software end user license agreement

This Software End User License Agreement ("Agreement") is between you (both the individual installing the Program and any single legal entity for which the individual is acting) ("You" or "Your") and Pioneer DJ Corporation ("Pioneer DJ").

TAKING ANY STEP TO SET UP OR INSTALL THE PROGRAM MEANS THAT YOU ACCEPT ALL OF THE TERMS OF THIS LICENSE AGREEMENT. PERMISSION TO DOWNLOAD AND/OR USE THE PROGRAM IS EXPRESSLY CONDITIONED ON YOUR FOLLOWING THESE TERMS. WRITTEN OR ELECTRONIC APPROVAL IS NOT REQUIRED TO MAKE THIS AGREEMENT VALID AND ENFORCEABLE. IF YOU DO NOT AGREE TO ALL OF THE TERMS OF THIS AGREEMENT, YOU ARE NOT AUTHORIZED TO USE THE PROGRAM AND MUST STOP INSTALLING IT OR UNINSTALL IT, AS APPLICABLE.

1 DEFINITIONS

- 1 "Documentation" means written documentation, specifications and help content made generally available by Pioneer DJ to aid in installing and using the Program.
- 2 "Program" means all or any part of Pioneer DJ's software licensed to You by Pioneer DJ under this Agreement.

2 PROGRAM LICENSE

- 1 Limited License. Subject to this Agreement's restrictions, Pioneer DJ grants to You a limited, non-exclusive, non-transferable, license (without the right to sublicense):
 - a To install a single copy of the Program in Your computer or mobile device, to use the Program only for Your personal purpose complying with this Agreement and the Documentation ("Authorized Use");
 - b To use the Documentation in support of Your Authorized Use; and
 - c To make one copy of the Program solely for backup purposes, provided that all titles and trademark, copyright and restricted rights notices are reproduced on the copy.
- 2 Restrictions. You will not copy or use the Program or Documentation except as expressly permitted by this Agreement. You will not transfer, sublicense, rent, lease or lend the Program, or use it for third-party training, commercial time-sharing or service bureau use. You will not Yourself or through any third party modify, reverse engineer, disassemble or decompile the Program, except to the extent expressly permitted by applicable law, and then only after You have notified Pioneer DJ in writing of Your intended activities.
- 3 Ownership. Pioneer DJ or its licensor retains all right, title and interest in and to all patent, copyright, trademark, trade secret and other intellectual property rights in the Program and Documentation, and any derivative works thereof. You do not acquire any other rights, express or implied, beyond the limited license set forth in this Agreement.
- 4 No Support. Pioneer DJ has no obligation to provide support, maintenance, upgrades, modifications or new releases for the Program or Documentation under this Agreement.

3 WARRANTY DISCLAIMER

THE PROGRAM AND DOCUMENTATION ARE PROVIDED "AS IS" WITHOUT ANY REPRESENTATIONS OR WARRANTIES, AND YOU

AGREE TO USE THEM AT YOUR SOLE RISK. TO THE FULLEST EXTENT PERMISSIBLE BY LAW, PIONEER DJ EXPRESSLY DISCLAIMS ALL WARRANTIES OF ANY KIND WITH RESPECT TO THE PROGRAM AND DOCUMENTATION, WHETHER EXPRESS, IMPLIED, STATUTORY, OR ARISING OUT OF COURSE OF PERFORMANCE, COURSE OF DEALING OR USAGE OF TRADE, INCLUDING ANY WARRANTIES OF MERCHANTABILITY, FITNESS FOR A PARTICULAR PURPOSE, SATISFACTORY QUALITY, ACCURACY, TITLE OR NON-INFRINGEMENT.

4 EXPORT CONTROL AND COMPLIANCE WITH LAWS AND REGULATIONS

You may not use or otherwise export or re-export the Program except as authorized by United States law and the laws of the jurisdiction in which the Program was obtained. In particular, but without limitation, the Program may not be exported or re-exported (a) into any U.S.-embargoed countries or (b) to anyone on the U.S. Treasury Department's Specially Designated Nationals List or the U.S. Department of Commerce Denied Persons List or Entity List. By using the Program, you represent and warrant that you are not located in any such country or on any such list. You also agree that you will not use the Program for any purposes prohibited by United States law, including, without limitation, the development, design, manufacture, or production of nuclear, missile, or chemical or biological weapons.

5 U.S. GOVERNMENT RESTRICTED RIGHTS

The Program and Documentations are "commercial computer software" and "commercial computer software documentation" as those terms are defined in 48 C.F.R. §252.227-7014 (a) (1) (2007) and 252.227-7014 (a) (5) (2007). The U.S. Government's rights with respect to the Program and Documentations are limited by this license pursuant to 48 C.F.R. §12.212 (Computer software) (1995) and 48 C.F.R. §12.211 (Technical data) (1995) and/or 48 C.F.R. §227.7202-3, as applicable. As such, the Program and Documentations are being licensed to the U.S. Government end users: (a) only as "commercial items" as that term is defined in 48 C.F.R. §2.101 generally and as incorporated in DFAR 212.102; and (b) with only those limited rights as are granted to the public pursuant to this license. Under no circumstance will the U.S. Government or its end users be granted any greater rights than we grant to other users, as provided for in this license. Manufacturer is Pioneer DJ Corporation, 1-1 Shin-Ogura, Saiwai-ku, Kawasaki-shi, Kanagawa, 212-0031 Japan

6 DAMAGES AND REMEDIES FOR BREACH

You agree that any breach of this Agreement's restrictions would cause Pioneer DJ irreparable harm for which money damages alone would be inadequate. In addition to damages and any other remedies to which Pioneer DJ may be entitled, You agree that Pioneer DJ may seek injunctive relief to prevent the actual, threatened or continued breach of this Agreement.

7 TERMINATION

Pioneer DJ may terminate this Agreement at any time upon Your breach of any provision. If this Agreement is terminated, You will stop using the Program, permanently delete it from your computer or mobile device where it resides, and destroy all copies of the Program and Documentation in Your possession, confirming to Pioneer DJ in writing that You have done so. Sections 2.2, 2.3, 2.4, 3, 4, 5, 6, 7 and 8 will continue in effect after this Agreement's termination.

8 GENERAL TERMS

- 1 Limitation of Liability. In no event will Pioneer DJ or its subsidiaries be liable in connection with this Agreement or its subject matter, under any theory of liability, for any indirect, incidental, special, consequential or punitive damages, or

damages for lost profits, revenue, business, savings, data, use, or cost of substitute procurement, even if advised of the possibility of such damages or if such damages are foreseeable. In no event will Pioneer DJ's liability for all damages exceed the amounts actually paid by You to Pioneer DJ or its subsidiaries for the Program. The parties acknowledge that the liability limits and risk allocation in this Agreement are reflected in the Program price and are essential elements of the bargain between the parties, without which Pioneer DJ would not have provided the Program or entered into this Agreement.

- 2 The limitations or exclusions of warranties and liability contained in this Agreement do not affect or prejudice Your statutory rights as consumer and shall apply to You only to the extent such limitations or exclusions are permitted under the laws of the jurisdiction where You are located.
- 3 Severability and Waiver. If any provision of this Agreement is held to be illegal, invalid or otherwise unenforceable, that provision will be enforced to the extent possible or, if incapable of enforcement, deemed to be severed and deleted from this Agreement, and the remainder will continue in full force and effect. The waiver by either party of any default or breach of this Agreement will not waive any other or subsequent default or breach.
- 4 No Assignment. You may not assign, sell, transfer, delegate or otherwise dispose of this Agreement or any rights or obligations under it, whether voluntarily or involuntarily, by operation of law or otherwise, without Pioneer DJ's prior written consent. Any purported assignment, transfer or delegation by You will be null and void. Subject to the foregoing, this Agreement will be binding upon and will inure to the benefit of the parties and their respective successors and assigns.
- 5 Entire Agreement. This Agreement constitutes the entire agreement between the parties and supersedes all prior or contemporaneous agreements or representations, whether written or oral, concerning its subject matter. This Agreement may not be modified or amended without Pioneer DJ's prior and express written consent, and no other act, document, usage or custom will be deemed to amend or modify this Agreement.
- 6 You agree that this Agreement shall be governed and construed by and under the laws of Japan.

Cautions on Installation

- Before installing the driver software, be sure to turn off the power of this unit and disconnect the USB cable from both this unit and your computer.
- If you connect this unit to your computer without installing the driver software first, an error may occur on your computer depending on the system environment.
- If you have discontinued the installation process in progress, step through the installation process again from the beginning according to the following procedure.
- Read *Software end user license agreement* carefully before installing this unit's proprietary driver software.
- Before installing the driver software, terminate all other programs running on your computer.
- The driver software is compatible with the following OSs.

Supported operating systems

macOS Sierra 10.12 (latest updated)		✓
OS X: 10.11, 10.10, 10.9 (latest update)		✓
Windows® 10 (latest service pack)	32-bit version	✓
	64-bit version	✓
Windows® 8.1 (latest service pack)	32-bit version	✓
	64-bit version	✓
Windows Pro® 8.1 (latest service pack)	32-bit version	✓
	64-bit version	✓
Windows® 7 Home Premium/Professional/Ultimate (latest service pack)	32-bit version	✓
	64-bit version	✓

Checking the latest information on the driver software

For the latest information on this unit's dedicated driver software, see the Pioneer DJ site below.
pioneerdj.com/support/

Obtaining the driver software

- 1 **Launch a web browser on the computer and access the Pioneer DJ site below.**
pioneerdj.com/support/
- 2 **Click the [FIND SOFTWARE & FIRMWARE UPDATES] icon.**
- 3 **Type [INTERFACE 2] into the search bar and click the link that appears.**
- 4 **After clicking [Drivers], download the latest driver software from the download page.**
 - Download the driver for either Windows or Mac from the download page.

Installing the driver software

Depending on the Operating System (OS) of your computer, procedures differ.

Do not connect the unit to your computer until the installation has completed.

- If a program is opened on your computer, close it.

Installation procedure (Mac)

Read *Cautions on Installation* carefully before installing the driver software.

- To install or uninstall the driver software, you need to be authorized by the administrator of your computer. Have the name and password of the administrator of your computer ready in advance.

- 1 **Double-click the file for Mac (INTERFACE2_M_X.X.X.dmg) downloaded in Obtaining the driver software.**
- 2 **Double-click [INTERFACE 2_AudioDriver.pkg].**
The driver software installation screen appears.
- 3 **Check the details on the screen and click [Continue].**
- 4 **When the end user license agreement appears, read *Software end user license agreement* carefully, then click [Continue].**
- 5 **If you consent to the provisions of the *Software end user license agreement*, click [Agree].**
If you do not consent to the provisions of the *Software end user license agreement*, click [Disagree] and stop installation.
- 6 **Proceed with installation according to the instructions on the screen.**
 - Click [Cancel] to cancel installation after it has started.

Installation Procedure (Windows)

Read *Cautions on Installation* carefully before installing the driver software.

- To install or uninstall the driver software, you need to be authorized by the administrator of your computer. Log on as the administrator of your computer before proceeding with the installation.

- 1 **Double-click the file for Windows (INTERFACE2_X.XXX.exe) downloaded in Obtaining the driver software.**

The driver software installation screen appears.

2 Carefully read the *Software end user license agreement* and if you consent to the provisions, put a check mark in [I agree.] and click [OK].

If you do not consent to the provisions of the *Software end user license agreement*, click [Cancel] and stop installation.

3 Proceed with installation according to the instructions on the screen.

If [Windows Security] appears on the screen while the installation is in progress, click [Install this driver software anyway] and continue with the installation.

- When the installation program is completed, a completion message appears.

Additional information

Troubleshooting

- If you think that there is something wrong with this unit, check the items below, and check [FAQ] for [INTERFACE2] on the Pioneer DJ site. pioneerdj.com/support/
Also, check the connected devices. If the problem cannot be resolved, ask your nearest Pioneer authorized service center or your dealer to carry out repair work.
- This unit may not operate properly due to static electricity or other external influences. In such cases, normal operation may be restored by unplugging the power cord then plugging it back in.

Problem	Check	Remedy
The power cannot be turned on. All indicators do not light up.	Is the supplied AC adaptor properly connected?	Connect the supplied AC adaptor properly to the DC IN terminal (page 6).
	Is the supplied USB cable properly connected?	Connect this unit and the computer directly using the supplied USB cable (page 7).
	Is the power supply capacity of the USB port on the connected computer low?	When connecting this unit and the computer using the computer's USB bus power, connect to the USB port that can supply enough power. If devices not used for DJ play are connected to other USB ports, unplug them and secure power. The connected computer is not driven with the battery. Supply power from the AC adaptor.
There is no sound or the volume is too low. Sound is distorted.	Are the connection cables properly connected?	Connect the connection cables properly (page 6).
	Are the terminals and plugs dirty?	Clean the terminals and plugs before making connections.
	Is the input selector switch on the rear panel set properly?	Set the input selector switch properly (page 6).
	Have you connected the output terminals on this unit to the PHONO input terminals on the mixer?	The output terminals on this unit are output using a line level. Connect to the LINE input terminals on the mixer.
Sound is distorted when an analog player is connected to this unit's input terminals.	Have you connected an analog player with a built-in phono equalizer?	When connecting the analog player with a built-in phono equalizer, switch the input selector switch to [LINE]. If the analog player with the built-in phono equalizer has an input selector switch, set it to [PHONO].
This unit is not recognized after it has been connected to a computer.	Is the supplied USB cable properly connected?	Connect this unit and the computer directly using the supplied USB cable (page 7).
	Are USB hubs used?	USB hubs cannot be used. Connect this unit and the computer directly using the supplied USB cable.
	Is the driver software properly installed on your computer?	Install the driver software. If it is already installed, reinstall it (page 15).
Sound of a computer cannot be output from this unit.	Are this unit and computer properly connected?	Connect this unit and the computer directly using the included USB cable (page 7).
	Are the audio output device settings properly set?	Select this unit with the audio output device settings. For instructions on making settings for your application, see your application's operating instructions.
	Is [Output Routing] of Settings Utility properly set?	Set [Output Routing] of Settings Utility to [USB] (page 13).

About trademarks and registered trademarks

- Pioneer DJ is a trademark of PIONEER CORPORATION, and is used under license.
 - rekordbox is a trademark or registered trademark of the Pioneer DJ Corporation.
 - Windows is a registered trademark of Microsoft Corporation in the United States and other countries.
 - Adobe and Reader are trademarks of Adobe Systems Incorporated in the U.S. and other countries.
 - macOS, OS X and Finder are trademarks of Apple Inc., registered in the U.S. and other countries.
 - Intel and Intel Core are trademarks of Intel Corporation in the U.S. and/or other countries.
 - ASIO is a trademark of Steinberg Media Technologies GmbH.
- The names of companies and products mentioned herein are trademarks or registered trademarks of their respective owners.

Cautions on copyrights

rekordbox restricts playback and duplication of copyright-protected music contents.

- When coded data, etc., for protecting the copyright is embedded in the music contents, it may not be possible to operate the program normally.
- When rekordbox detects that coded data, etc., for protecting the copyright is embedded in the music contents, processing (playback, reading, etc.) may stop.

Recordings you have made are for your personal enjoyment and according to copyright laws may not be used without the consent of the copyright holder.

- Music recorded from CDs, etc., is protected by the copyright laws of individual countries and by international treaties. It is the full responsibility of the person who has recorded the music to ensure that it is used legally.
- When handling music downloaded from the Internet, etc., it is the full responsibility of the person who has downloaded the music to ensure that it is used in accordance with the contract concluded with the download site.
- The specifications and design of this product are subject to change without notice.