



PEAK

user guide



Novation
A division of Focusrite Audio Engineering Ltd.
Windsor House
Turnpike Road
Cressex Business Park
High Wycombe
Buckinghamshire
HP12 3FX
United Kingdom

Tel: +44 1494 462246
Fax: +44 1494 459920
e-mail: sales@novationmusic.com
Web: <http://www.novationmusic.com>

Trade marks

The Novation trade mark is owned by Focusrite Audio Engineering Ltd. All other brand, product and company names and any other registered names or trade marks mentioned in this manual belong to their respective owners.

Disclaimer

Novation has taken all possible steps to ensure that the information given here is both correct and complete. In no event can Novation accept any liability or responsibility for any loss or damage to the owner of the equipment, any third party, or any equipment which may result from use of this manual or the equipment which it describes. The information provided in this document may be modified at any time without prior warning. Specifications and appearance may differ from those listed and illustrated.

COPYRIGHT AND LEGAL NOTICES

Novation is a registered trade mark of Focusrite Audio Engineering Limited.
Peak and New Oxford Oscillator are trade marks of Focusrite Audio Engineering Limited.

2017 © Focusrite Audio Engineering Limited. All rights reserved.

CONTENTS

COPYRIGHT AND LEGAL NOTICES	2	APPENDIX	36
INTRODUCTION	4	System Updates using Novation Components	36
Key Features	4	Patch import via SysEx	36
About This Manual	4	Sync values tables	36
What's in the box	4	Arp/Clock Sync Rate	36
Registering your Novation Peak	4	Delay Sync Rate	36
Power Requirements	4	LFO Sync Rate	36
HARDWARE OVERVIEW	5	Init Patch – parameter table	37
Top Panel	5	Modulation Matrix – sources	38
Controls, section by section	5	Modulation Matrix – destinations	38
Rear Panel	8	MIDI parameters list	38
GETTING STARTED	9		
Menu Navigation	11		
Loading Patches	11		
Saving Patches	11		
Basic Operation – sound modification	12		
The OLED display	12		
Parameter adjustment	12		
The Filter knob	12		
Pitch and Mod wheels	12		
The Arpeggiator	12		
MIDI control	12		
The Animate Buttons	12		
SYNTHESIS TUTORIAL	13		
PEAK: SIMPLIFIED BLOCK DIAGRAM	17		
PEAK IN DETAIL	17		
The Oscillator Section	17		
Wave	17		
Pitch	18		
Pitch Modulation	18		
Shape	18		
The Oscillator Menu	18		
The LFO Section	20		
LFO Waveform	20		
LFO Rate	20		
LFO Fade Time	20		
The LFO Menu	20		
The Mixer Section	22		
The Envelopes Section	22		
The Envelopes Menu	23		
The Filter Section	24		
Filter type	24		
Frequency	24		
Resonance	24		
Filter modulation	24		
Filter tracking	25		
Overdrive	25		
The Modulation Matrix	26		
Glide	27		
Voices	27		
The Arpeggiator	29		
Arp data transmission	29		
The Arp/Clock Menu	29		
The Effects Section	31		
Distortion	31		
Chorus	31		
Delay	31		
Reverb	31		
The FX Menu	31		
The Settings Menu	33		

INTRODUCTION

Thank you for purchasing this Peak eight voice polyphonic desktop synthesiser, the best sounding synth Novation has ever made. Peak evolved from an initial concept of a polyphonic version of the Bass Station II analogue synth, but we decided on a radically new approach to sound generation, and developed the New Oxford Oscillators. These Numerically Controlled Oscillators (NCOs) combine the enormous flexibility afforded by digital control with the organic warmth expected from an analogue synth.

As well as superlative sound quality, Peak gives you a great set of specially-created presets and some equally exciting effects. Peak can be used in the studio or on stage with the MIDI controller of your choice, be it a keyboard, DAW or with a pad controller such as the Novation Launchpad Pro. It has a CV (Control Voltage) Input to let you interface with Eurorack and other CV-capable synths you may already have.

NOTE: Peak is capable of generating audio with a large dynamic range, the extremes of which can cause damage to loudspeakers or other components, and also to your hearing!

Key Features

- FPGA-based Numerically Controlled Oscillators running at 24 MHz generate waveforms indistinguishable from those produced by analogue oscillators
- Eight-voice polyphony
- Three multi-waveform oscillators per voice
- Waveform shaping on all waveform types
- Analogue signal path – filters, distortions, VCA
- Traditional, dedicated function rotary controls
- LP/BP/HP filter with variable slope, resonance, overdrive and modulation options
- Two independent LFO sections
- Separate Amp and Mod Envelope sections with ADSR fader controls
- Ring Modulator (inputs: Oscs 1 and 2)
- Versatile arpeggiator with wide range of patterns
- Glide (portamento) with dedicated time control
- Pre-loaded with 256 brand new Patches
- Memory for 256 additional User Patches
- Two Animate buttons for adding spot effects in live performance
- Powerful effects: distortion, delay, chorus and reverb
- Class-compliant USB port (no drivers required), patch dump and MIDI
- OLED display for patch selection and parameter adjustment
- External DC input (for supplied AC PSU)
- External CV input for integration with other analogue equipment
- Headphone output
- Supports any two pedals – sustain or expression
- Kensington Security Slot
- Optional stand available

About This Manual

We've tried to make this manual as helpful as possible for all types of user, and this inevitably means that more experienced users will want to skip over certain parts of it, while those with a bit less synth experience will want to avoid certain parts of it until they're confident they've mastered the basics. As with other Novation synthesiser User Guides, we've included a "Synthesis Tutorial" (see page 13) which explains the principles of sound generation and treatment that are the foundation of all synthesisers. We think this will be of help and interest to all users.

There are a few general points that are useful to know before you continue reading this manual. We've adopted some graphical conventions within the text, which we hope all types of user will find helpful in navigating through the information to find what they need to know quickly:

Abbreviations, conventions, etc.

Where top panel controls or rear panel connectors are referred to, we've used a number thus: **1** to cross-reference to the top panel diagram, and thus: **1** to cross-reference to the rear panel diagram. (See page 5 and page 8).

We've used **BOLD TEXT (or Bold Text)** to name top panel controls or rear panel connectors; we've made a point of using exactly the same names as appear on Peak itself. We've used `Dot Matrix text` to illustrate text and numbers that appear on the top panel display.

Tips



These do what it says on the tin: we include bits of advice, relevant to the topic being discussed that should simplify setting up Peak to do what you want. It's not mandatory that you follow them, but generally they should make life easier.

Extra Info



These are additions to the text that will be of interest to the more advanced user and can generally be avoided by the less experienced. They are intended to provide a clarification or explanation of a particular area of operation.

What's in the box

Your Peak synthesiser has been carefully packed in the factory and the packaging was designed to withstand rough handling. Should the unit appear to have been damaged in transit, do not discard any of the packing material and notify your music dealer.

If practical, save all the packing materials in case you ever need to ship the unit again.

Please check the list below against the contents of the packaging. If any items are missing or damaged, contact the Novation dealer or distributor where you purchased the unit.

- Peak synthesiser
- DC power supply unit (PSU)
- USB cable, A-type to B-type, 1.5 m
- Safety information sheet
- "Getting Started" Guide, also providing online access to:
 - Loopmasters Sample Content
 - Ableton Live Lite

Registering your Novation Peak

It is important to register your Peak online at novationmusic.com/register, using the information provided in the Getting Started Guide. This will allow you to download the additional software that you are entitled to as a Peak owner from your Novation account.

Power Requirements

Peak is shipped with an external 12 V DC, 1 A power supply. This is a "universal" type, and will operate on all mains voltages between 100 V and 240 V.

The centre pin of the coaxial connector is the positive (+ve) side of the supply. Peak must be powered by the supplied AC-to-DC mains adaptor.

Your Peak will be supplied with the a version of the PSU appropriate to your territory. In some countries the PSU comes with detachable adaptors; in this case, use the one that fits your country's AC outlets. When powering Peak with the mains PSU, please ensure that your local AC supply is within the range of voltages required by the adaptor – i.e., 100 to 240 VAC - BEFORE you plug it into the mains.

We strongly recommend that you only use the supplied PSU. Using alternative PSUs will invalidate your warranty. Power supplies for your Novation product can be purchased from your music dealer if you have lost yours.

HARDWARE OVERVIEW

Top Panel

Peak's control surface is divided logically into functional areas, with signal generation and treatment broadly following a left-to-right sequence.

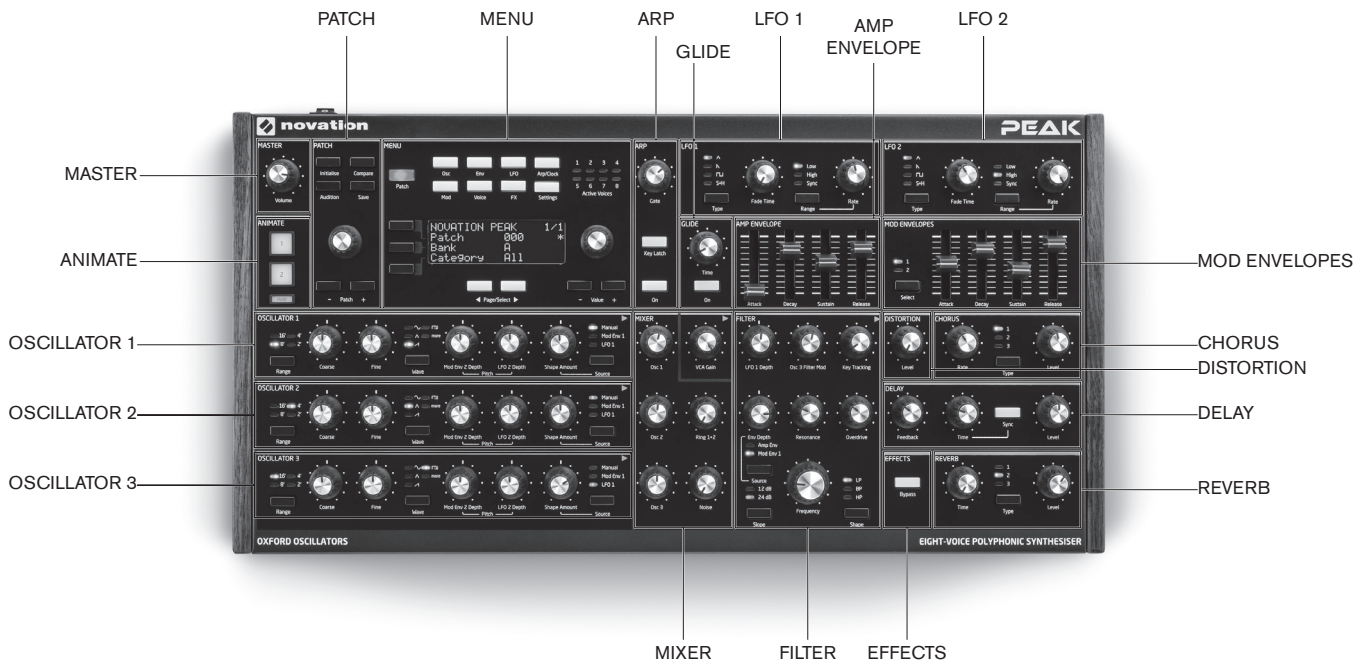

- **PATCH** – load and save Patches
- **OSCILLATOR 1** – Primary sound generator
- **OSCILLATOR 2** – Primary sound generator
- **OSCILLATOR 3** – Primary sound generator
- **LFO 1** – low frequency oscillator, modulates filter and oscillator Shape
- **LFO 2** – low frequency oscillator, modulates the pitch of Oscs 1, 2 & 3
- **MIXER** – sums oscillator waveforms, ring modulator output and noise
- **AMP ENVELOPE** – controls how signal amplitude varies with time
- **MOD ENVELOPES** – controls how other synth parameters vary over time
- **GLIDE** – enables a glide between successive notes
- **ARP** – arpeggiator function generates note patterns
- **FILTER** – modifies frequency content of signal
- **EFFECTS** – adds distortion, echo, reverb and chorus effects to overall sound
- **MENU** – 4 x 20 character display for Patch selection and extended parameter control
- **ANIMATE** – momentary buttons for instant sound modification

Controls, section by section

PATCH:

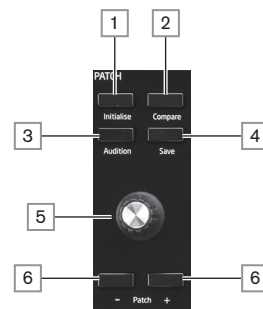

- 1 Initialise** – press this button to reset all synth parameters to the default values of the Initial Patch – see "Init Patch – parameter table" on page 37 for a list. This provides a rapid way getting back to a bare "starting point" for fresh sound creation.
- 2 Compare** – press (and hold) this button to hear an "unmodified" version of the currently loaded Patch. This allows you to compare the original version with the effects of any tweaking that you've done since loading it.
- 3 Audition** – press to hear the current synth sound even without a keyboard (or other controller) connected. The note played will always be middle C (C3). This corresponds to MIDI note number 60.
- 4 Save** – use in conjunction with **Patch** keys **6** to save modified Patches in memory.
- 5 Patch select** – use this rotary control to select a Patch, or a different memory location in which to save a modified Patch or new sound.
- 6 Patch +/-** – these buttons provide an alternative method of scrolling through Patches.

OSCILLATORS:

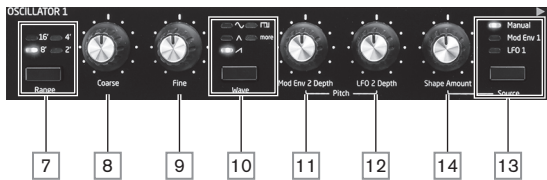

The three Oscillators have identical sets of controls. All have further parameters available for adjustment via the menu system; these are described in detail later in the User Guide.

7 Range – steps through the oscillator’s base pitch ranges. For standard concert pitch (A3 = 440 Hz), set to **8**.

8 Coarse – adjusts the pitch of the selected oscillator over a range of ± 1 octave.

9 Fine – adjusts the oscillator pitch over a range of ± 100 cents (± 1 semitone).

10 Wave – steps through the range of available oscillator waveforms – sine, triangular, sawtooth, pulse and **more** (the menu offers various additional waveforms for **more**).

11 Mod Env 2 Depth – controls the degree by which the oscillator pitch changes as a result of modulation by Envelope 2. All Modulation Depth controls are “centre-zero” and thus both pitch increases and decreases can be obtained.

12 LFO 2 Depth – controls the degree by which the oscillator pitch changes as a result of modulation by LFO 2. Pitch changes are bi-polar (up and down); uni-polar pitch modulation is available by the use of the Modulation Matrix.

13 Source – this button selects a source for further variation of the waveform shape. The options are: modulation by Envelope 1 (**Mod Env 1**), modulation by LFO 1 (**LFO 1**) or manual control by the **Shape Amount** control **14**.

14 Shape Amount – controls further modifications of the waveform shape, and is active for all wave shapes. With pulse waves, it adjusts the pulse width; with sine, triangle and sawtooth waves, it makes subtle changes to the wave shape. When **more** is selected by the **Wave** switch **10**, the control selects different areas of the wavetable. When **Source** **13** is set to **Mod Env 1** or **LFO 1**, it acts as a Modulation Depth control. Note that the wave shape may be modulated by more than one source simultaneously, by differing amounts.

LFO 1 & LFO 2:

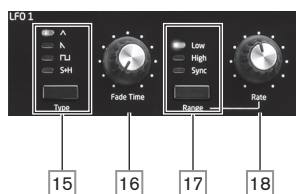

The two LFOs have identical sets of controls. Both have further parameters available for adjustment via the menu system; these are described in detail later in the User Guide. The outputs of either LFO may be used to modulate numerous other synth parameters.

15 Type – steps through the available waveforms: triangle, sawtooth, square, sample and hold. The associated LEDs give a visual indication of the LFO speed and waveform.

16 Fade Time – sets the timing of the LFO’s action: it is possible to “ramp” the LFO up or down or to delay its effect. The options are set in the LFO menu.

17 Range – selects **High** or **Low**; the third option is **Sync**, which synchronises the LFO frequency to the internal arp clock or to an external MIDI clock if one is present..

18 Rate – sets LFO frequency.

MIXER:

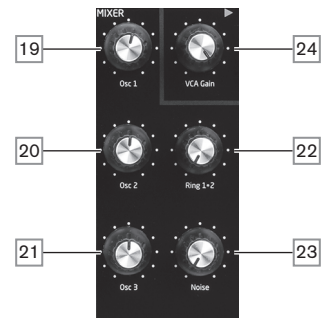

19 Osc 1 – controls level of Oscillator 1’s waveform.

20 Osc 2 – controls level of Oscillator 2’s waveform

21 Osc 3 – controls level of Oscillator 3’s waveform

22 Ring 1*2 – controls the Ring Modulator output level: the inputs to the Ring Modulator are Osc 1 and Osc 2.

23 Noise – controls how much white noise is added.

24 VCA Gain – this effectively controls the mixer output level: it adjusts the signal level between the Amp Envelope and Effects sections. See page 17.

AMP ENVELOPE, MOD ENVELOPES:

All three envelopes have further parameters available for adjustment via the menu system; these are described in detail later in the User Guide.

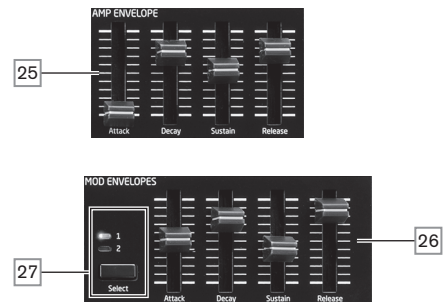

25 Amp Envelope controls – a set of four 30 mm sliders adjusting the standard ADSR parameters (Attack, Decay, Sustain and Release) of the amplitude envelope.

26 Mod Envelope controls – an identical set of sliders, adjusting the parameters of the two modulation envelopes (see **27** below).

27 Select – Peak generates two independent Mod Envelopes; this button selects which of these (**Mod 1** or **Mod 2**) the Mod Envelope sliders **26** control.

GLIDE:



28 Time – sets the portamento glide time.

29 On – enables/disables the Glide function.

ARP:

The Arpeggiator has further parameters available for adjustment via the menu system; these include basic settings such as BPM, pattern selection and octave range. These are described in detail later in the User Guide.

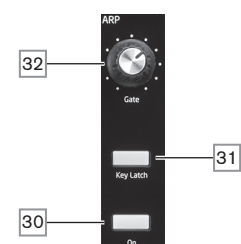

30 On – turns the Arpeggiator on and off.

31 Key Latch – when the Arpeggiator is running, pressing Key Latch simulates the effect of holding the keys down continuously, until the keys are released.

32 Gate – sets the basic duration of the notes played by the Arpeggiator.

FILTER:

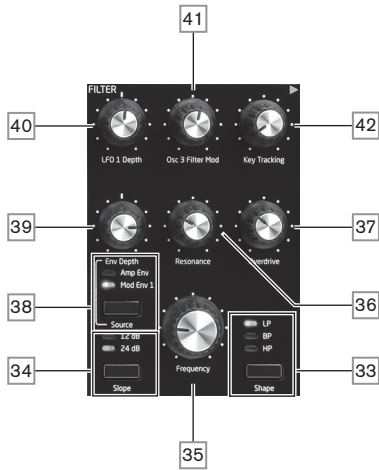

- 33 **Shape** – steps through the three types of filter: low-pass (**LP**), band-pass (**BP**) or high-pass (**HP**).
- 34 **Slope** – sets the slope of filter to either **12dB** or **24dB** per octave.
- 35 **Frequency** – large rotary knob controlling the filter's cut-off frequency (LP or HP), or its centre frequency (BP).
- 36 **Resonance** – adds resonance (an increased response at the filter frequency) to the filter characteristic.
- 37 **Overdrive** – adds a degree of pre-filter distortion to the mixer output.
- 38 **Source** – selects whether the filter is to be varied by Mod Envelope 1 (**Mod Env 1**) or the Amp Envelope (**Amp Env**).
- 39 **Env depth** – controls the degree by which the filter frequency is modified by the envelope selected by **Source** 38.
- 40 **LFO 1 depth** – controls the degree by which the filter frequency is modified by LFO 1.
- 41 **Osc 3 Filter Mod** – allows the filter frequency to be modulated directly by Oscillator 3.
- 42 **Key Tracking** – controls the degree by which the keyboard position of the note being played varies the filter frequency between 0 and 100%

EFFECTS:

Peak's Effects section comprises three different DSP-based processors producing time-domain effects, plus an analogue distortion generator.

The Delay, Reverb and Chorus effects have further parameters available for adjustment via the menu system; these are described in detail later in the User Guide.

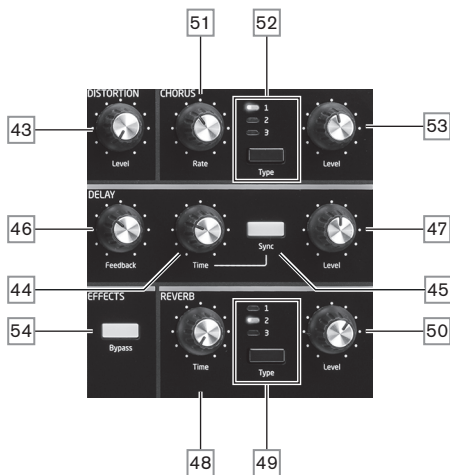

- 43 **DISTORTION: Level** – controls the amount of analogue distortion applied to the sum of all eight voices.
- 44 **DELAY: Time** – sets the timing of the delayed signal (echo) added to the original. Maximum delay is approx. 1.4 seconds.
- 45 **DELAY: Sync** – selecting Sync allows the delay time to be synchronised to the internal clock or an incoming MIDI clock.
- 46 **DELAY: Feedback** – allows the delayed signal to be fed back to the input of the delay processor, creating multiple echoes.
- 47 **DELAY: Level** – controls the volume of the delayed signal.
- 48 **REVERB: Time** – adjusts reverberation decay time. (The maximum time is longer than you'll ever be likely to need!)
- 49 **REVERB: Level** – controls the "amount" of reverberation.
- 50 **REVERB: Type** – lets you select one of three different chorus algorithms.
- 51 **CHORUS: Rate** – adjusts the rate of chorus modulation.
- 52 **CHORUS: Type** – lets you select one of three different chorus algorithms.
- 53 **CHORUS: Level** – controls the degree of chorus effect.

- 49 **REVERB: Type** – emulates spaces of three different sizes: **3** is the largest.
- 50 **REVERB: Level** – controls the "amount" of reverberation.
- 51 **CHORUS: Rate** – adjusts the rate of chorus modulation.
- 52 **CHORUS: Type** – lets you select one of three different chorus algorithms.
- 53 **CHORUS: Level** – controls the degree of chorus effect.
- 54 **EFFECTS: Bypass** – the three time-domain effects may be switched in or out with this button.

MENU:

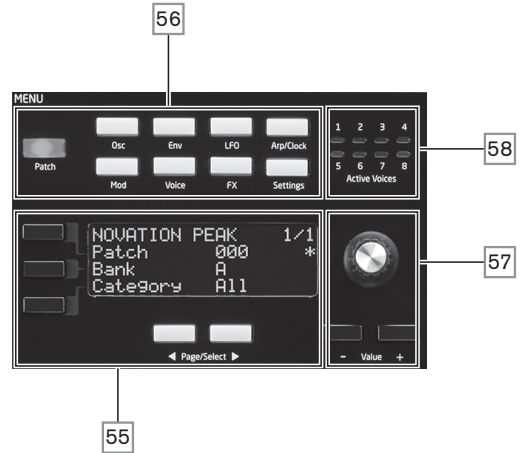

- 55 **20 character x 4 row OLED display**. Displays one of the nine menus selected by the buttons 56. Pages within each menu may be selected with the two **Page/Select** buttons below the display. Adjusting any of Peak's rotary controls (except **MASTER** and **PATCH**) invokes an alternative display showing the value of the parameter being adjusted until the control is released. The three buttons to the left of the display assign the parameter controls 57 to a particular row of the page being displayed.
- 56 **Nine buttons selecting the menu to be displayed: Patch, Osc, Env, LFO, Arp/Clock, Mod, Voice, FX and Settings.**
- 57 **Parameter adjustment** may either be made rapidly by the rotary control or incremented/decremented one parameter value at a time with the **Value + / Value -** buttons.
- 58 **Active Voice** – eight LEDs, indicating which of the eight voices are currently active.

ANIMATE:

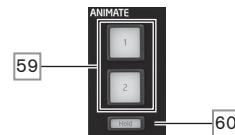

- 59 **ANIMATE 1 and 2** – add an "instant" effect to the sound currently being generated. These buttons are great in live performance: the nature of the extra effect will be determined by the Patch in use.
- 60 **Hold** – pressing **Hold** will "lock" the Animate function in an "On" state. You can either press **Hold** before pressing **ANIMATE**, or vice-versa. Pressing **ANIMATE** a second time releases both the Animate and Hold functions.

MASTER:

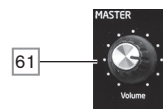

- 61 **Volume** – master volume control for the synth's audio output; this also controls the headphones output level.

Rear Panel



- ① **+12V DC** – connect the supplied PSU here.
- ② **POWER** – on/off switch.
- ③  – standard USB 2.0 or 3.0 port. Connect to a Type A USB port on a computer using the supplied cable. Note that the USB port only carries MIDI data, not audio.
- ④ **MIDI IN, OUT** and **THRU** – standard 5-pin DIN MIDI sockets for connecting Peak to a keyboard or other MIDI-equipped hardware.
- ⑤ **PEDAL 1** and **PEDAL 2** – two 3-pole (TRS) 1/4" jack sockets for connection of switch (e.g., sustain) and/or expression pedals. The sockets detect switch pedal polarity automatically. Expression pedals are also detected automatically and can be routed directly as sources available to the Modulation Matrix. Switch pedal functions are configured in the Settings menu.
- ⑥ **CV MOD IN** – 3.5 mm jack socket for connecting an external Control Voltage source in the range of +/-5 V. This permits other analogue instruments (equipped with a compatible CV output) to modulate Peak's sounds.
- ⑦ **OUTPUTS** – two 1/4" 3-pole (TRS) jack sockets carrying Peak's output signal. Use both **L/MONO** and **RIGHT** for full stereo; if **RIGHT** is unconnected, a mono (L+R) sum is available at **L/MONO**. Outputs are pseudo-balanced.
- ⑧ **HEADPHONES** – 3-pole (TRS) 1/4" jack socket for stereo headphones. Phones volume is adjusted by the **VOLUME** control [\[61\]](#).
- ⑨ Kensington Security Slot – to secure your synth.

GETTING STARTED

Peak may, of course, be used simply as a standalone synthesiser with a master keyboard connected to its **MIDI IN** socket. However, there are many more possibilities, and how you choose to integrate it into your existing synth/recording setup will be determined by the other equipment you have and your own imagination!

Below are three examples illustrating how Peak could form part of a synth setup. We've used Novation or Focusrite products throughout (we would, wouldn't we?), but of course you can use whatever equipment you have in your system provided it's functionally equivalent, of course. Note: for clarity, we've omitted audio signal paths from the diagrams.

Example 1

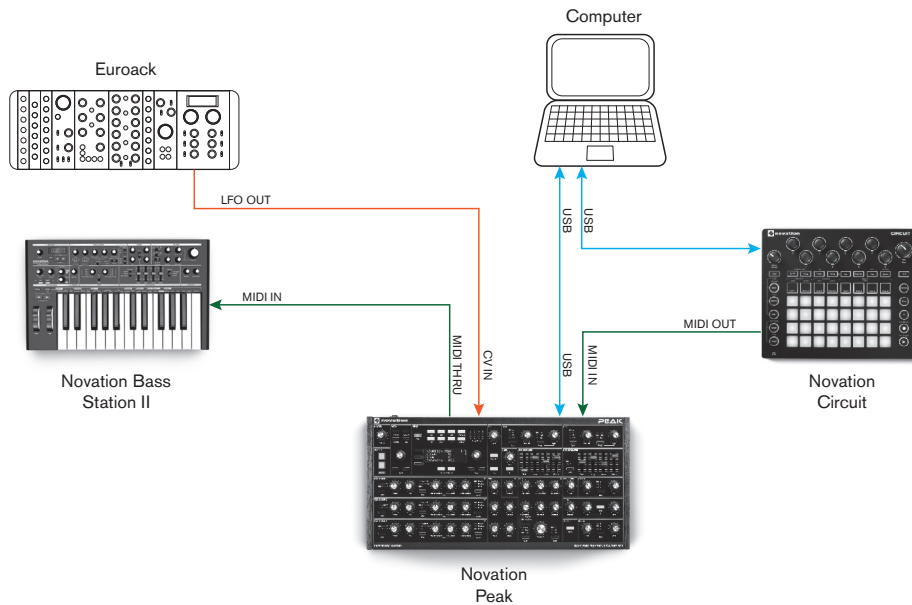

Here you could use a pad controller such as the Novation Circuit to trigger sounds both in Peak and another synth such as a Novation Bass Station II. An external modular LFO in a Eurorack could be used to modulate one or more parameters in Peak via the CV connection. All MIDI data gets recorded in the DAW via USB connections.

Example 2

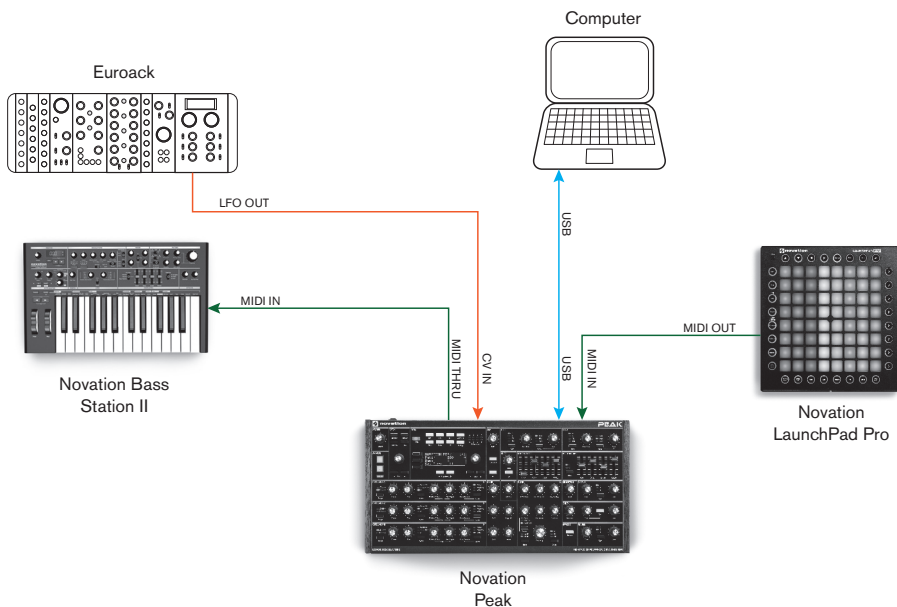

In the second example, a Launchpad Pro in stand-alone mode replaces the Circuit. This would permit Peak to be played directly from the Launchpad Pro, taking advantage of its polyphonic aftertouch capability.

Example 3

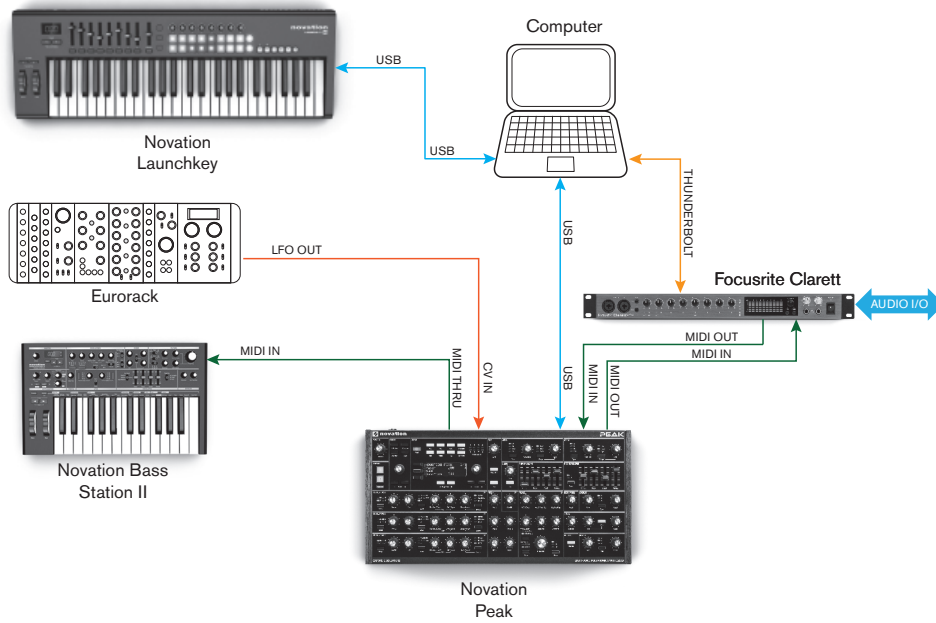

In this example, a Focusrite Clarett audio interface is used to enable "real-world" instruments to be recorded in the DAW as well as synth sounds. A keyboard controller is used to trigger both Peak and a second synth, such as a Bass Station II, with the Clarett converting MIDI data sent from the computer via a Thunderbolt link to conventional MIDI data.

The simplest and quickest way of finding out what Peak can do is to connect the rear panel outputs (7) – in either mono or stereo – to the input of a power amplifier, audio mixer, powered speaker or other means of monitoring the output.

If using Peak with other sound modules, connect **MIDI THRU** (4) to the next sound module's **MIDI IN**, and daisy-chain further modules in the usual way. If using Peak with a master keyboard, connect the master keyboard's **MIDI OUT** to **MIDI IN** on Peak, and ensure that the master keyboard is set to transmit on MIDI channel 1 (the synth's default channel).

With the amplifier or mixer off or muted, connect the AC adaptor to Peak (1), and plug it into the AC mains. Turn the synth on: after completing its boot sequence, Peak will load Patch 000, and the LCD display will confirm this:

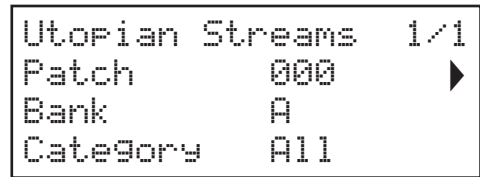

"Utopian Streams" is the name of the factory Patch in Bank A, memory location 000.

Turn on the mixer/amplifier/powerd speakers, and turn up the Volume control (61) until you have a healthy sound level from the speaker when you play.

Using headphones

Instead of a speaker and/or an audio mixer, you may wish to use a pair of headphones. These may be plugged into the rear panel headphone output socket (8). The main outputs are still active when headphones are plugged in. The **Volume** control (61) also adjusts headphone level.

NOTE: Peak's headphone amplifier is capable of outputting a high signal level; please take care when setting the volume.

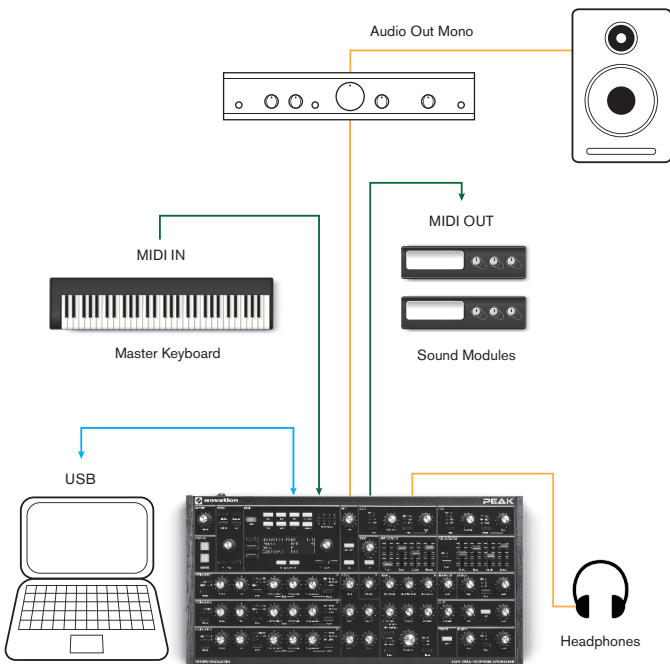

Menu Navigation

Although most of the key parameters affecting the nature of the sound Peak generates are immediately accessible through dedicated, "per-function" rotary controls and switches, many further parameters and synth settings can be modified using the OLED display and its associated controls.

Peak's menu system has been designed to be as simple and consistent as possible. The eight buttons above the display [56], plus **Patch**, select one of nine menus. Each menu has multiple pages: use the **Page/Select** buttons to scroll through the pages in sequence.

On each page, Row 1 is a "title" row and stays fixed. Rows 2, 3 and 4 each display a parameter for modification; some pages do not have all data in all rows. Use the three buttons to the left of the display to select the row to edit: the active row is indicated by an asterisk. The parameter value may be adjusted either by the rotary control or the **Value +/-** buttons.

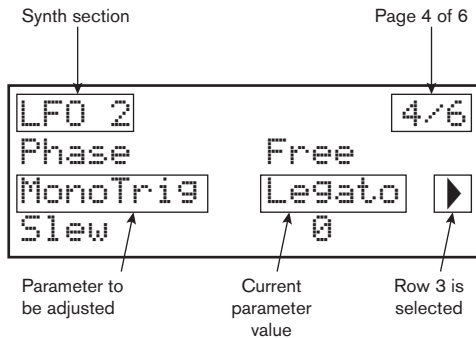

Loading Patches

Peak can store 512 Patches in memory, arranged in four Banks of 128; the Banks are designated A to D. Banks A and B are pre-loaded with 256 great factory Patches especially created for Peak, while Banks C and D are for storing your own Patches and come pre-loaded with the same default "initial" Patch Init Patch. See page 37 for the default synth parameters this Patch contains. This initial Patch will always be the starting point for creating new sounds "from scratch".

A Patch is loaded by simply selecting its number with the rotary patch selector [5] or the **Patch** buttons [6]. It is immediately active.

The Compare button [2] is a really useful feature as it lets you hear the Patch you loaded in its "factory" state, ignoring any changes or tweaks you've been making. Hold the button down to hear the original Patch: when you release it, you'll be back to your modified version. This is a useful feature to use when you're about to save a new Patch into a memory location that might already contain a Patch you want to retain – you can press **Compare** during the Save process to check what's in the intended memory location.

You can press **Initialise** [1] at any time to load a copy of the default initial Patch. Doing so does not overwrite the previous Patch, though you will lose any modifications that you made to it if you haven't saved it in a user Patch location.

If you're working without a keyboard, you can generate a note (corresponding to middle C) at any time by pressing **Audition** [3].



Note that when you change Patch, you lose the current synth settings. If the current settings were a modified version of a stored Patch, these modifications will be lost. Thus it is always advisable to save your settings before loading a new Patch. See Saving Patches.

Saving Patches

Patches can be saved to any of the 512 memory locations, but remember that if you save your settings to any location in Banks A or B, you will overwrite one of the factory presets.

To save a Patch press the **Save** button [4]. The OLED display changes as shown below:

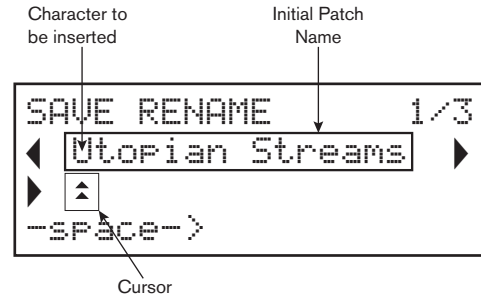

You can now give the Patch you want to save a name. The existing name is displayed initially; use the Row 2 button (▶) to move the cursor to the character position to be changed and then use the rotary parameter control [57] to select the new letter. Repeat this process one character at a time. Upper case, lower case, numbers, punctuation marks and space characters are all available in sequence from the rotary control. Use the Row 4 button to insert a space instead of a character. When you have entered the new name, press Page/Select ▶ to select Page 2, where you decide which memory location the modified Patch will be saved in.

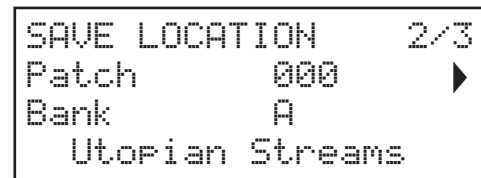

Now you can enter the memory location by Bank and number. Note that the name of the Patch currently in the memory location you select is displayed on Row 4, to remind you what it is in case it's something you don't want to overwrite. Press Page/Select ▶ again to select Page 3, and you can (if you wish) assign your Patch to one of several pre-determined categories.

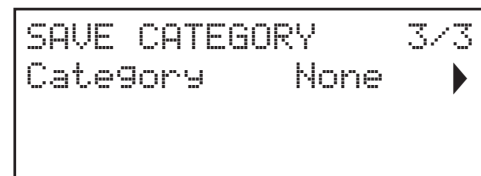

When you have done this, press **Save** again, and the display will confirm that the Patch is saved.



You may save a modified Patch to the same location, if you are happy for the earlier version to be overwritten. This can easily be achieved by pressing Save four times in succession.



Peak Factory Patches can be downloaded from the Novation website if they have been accidentally overwritten. See page 36.

Basic Operation – sound modification

Once you have loaded a Patch you like the sound of, you can modify the sound in many different ways using the synth controls. Each area of the control panel is dealt with in greater depth later in the manual, but a few fundamental points should be noted first.

The OLED display

The OLED display will show the last menu page selected until a rotary control or slider is moved on the control panel, when it changes to confirm the control being moved, together with the instantaneous parameter value and the parameter value for the currently loaded Patch:

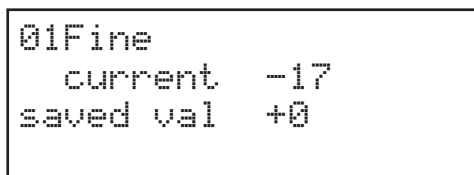

Many rotary controls have a parameter range of 0 to +127. Others are effectively "centre-off", and have a parameter range of either -64 to + 63 or -128 to +127.

The display reverts to the previous menu page a short time (user-definable) after the control is released. If no control is touched for 10 minutes, the display turns off, but will resume immediately a control or menu button is selected.

The one exception to this is the Master volume rotary control.

Parameter adjustment

As with traditional analogue synths, most of the primary sound modification controls on Peak are dedicated, physical rotary controls or switches, providing instant access to the most commonly needed sound parameters.

Many more parameters are available for adjustment in most of the synth sections via the menu system; these tend to be parameters that you wouldn't need immediate access to during a live performance. Those in the **Osc**, **Env**, **LFO**, **Arp/Clock**, **Voice** and **FX** menus all affect the relevant sections of sound generation and treatment directly, while the **Mod** menu lets you interconnect different synth sections with the Modulation Matrix.

The Filter knob

Adjusting the frequency of the synth's filter is probably the most commonly-used method of sound modification. For this reason, Filter **Frequency** has a large rotary control [35] near the bottom of the panel. Experiment with different types of patch to hear how changing the filter frequency alters the characteristic of different types of sound. Also listen to the effect of the three different filter Shapes.

Pitch and Mod wheels

Any MIDI keyboard controller used with Peak will be fitted with a standard pair of synthesiser control wheels, **Pitch** and **Mod** (Modulation). **Pitch** is usually spring-loaded and will return to its centre position. The range of control of Pitch is adjustable (with the **BendRange** parameter - see page 18) in semitone increments up to +/-2 octaves; the default setting is +/-1 octave.

The **Mod** wheel's precise function varies with the patch loaded; it is used in general to add expression or various elements to a synthesized sound. A common use is to add vibrato to a sound.

It is possible to assign the **Mod** wheel to alter various parameters making up the sound – or a combination of parameters simultaneously. This topic is discussed in more detail elsewhere in the manual. See "The Modulation Matrix" on page 26.

The Arpeggiator

Peak includes an arpeggiator (the '**ARP**'), which allows arpeggios of varying complexity and rhythm to be played and manipulated in real-time. The Arpeggiator is enabled by pressing the **Arp ON** button [30].

If a single key is pressed, the note will be retriggered by the arpeggiator, at a rate determined by the **ClockRate** parameter on Page 1 of the **Arp** menu. If you play a chord, the arpeggiator identifies its notes and plays them individually in sequence at the same rate (this is termed an arpeggio pattern or 'arp sequence'); thus if you play a C major triad, the selected notes will be C, E and G.

Adjusting **Gate** [32], and the **Type**, **Rhythm** and **Octaves** parameters on Page 2 of the **Arp** menu will alter the rhythm of the pattern, the way the sequence is played and the note range in a variety of ways. See "The Arpeggiator" on page 29 for full details.

MIDI control

Peak has a very high degree of MIDI implementation, and almost every control and synth parameter is able to transmit MIDI data to external equipment, and similarly, the synth may be controlled in almost every respect by incoming MIDI data from a DAW, sequencer or master control keyboard.

The **Settings** menu has numerous options for enabling various aspects of MIDI control, which include MIDI Channel setting, Arpeggio MIDI Out, Aftertouch, CC/NRPN transmit/receive and Program/Bank Change transmit/receive. Please see page 33 for full details.

The factory default is for all MIDI transmit/receive options to be On, and MIDI Channel 1 is set as the active channel.

The Animate Buttons

Each of the two **ANIMATE** buttons [59] may be programmed to provide an instant modification to the synth's sound, which persists for as long as the button is pressed. This is a great way of adding sound effects "on the fly" in live performance.



The **ANIMATE** buttons are programmed using the Modulation Matrix, and appear in the list of Sources on Page 2 of the **Mod** menu. Each button may be assigned as a modulating source for any of the Destinations available in the Mod Matrix. See page 26 for full details.

SYNTHESIS TUTORIAL

This section covers the general principles of electronic sound generation and processing in more detail, including references to Peak's facilities where relevant. It is recommended that this chapter is read carefully if analogue sound synthesis is an unfamiliar subject. Users familiar with this subject can skip this section and move on to the next.

To gain an understanding of how a synthesiser generates sound it is helpful to have an appreciation of the components that make up a sound, both musical and non-musical.

The only way that a sound may be detected is by air vibrating the eardrum in a regular, periodic manner. The brain interprets these vibrations (very accurately) into one of an infinite number of different types of sound.

Remarkably, any sound may be described in terms of just three properties, and all sounds always have them. They are:

- Pitch
- Tone
- Volume

What makes one sound different from another is the relative magnitudes of the three properties as initially present in the sound, and how the properties change over the duration of the sound.

With a musical synthesiser, we deliberately set out to have precise control over these three properties and, in particular, how they can be changed during the "lifetime" of the sound. The properties are often given different names: Volume may be referred to as Amplitude, Loudness or Level, Pitch as Frequency and Tone as Timbre.

Pitch

As stated, sound is perceived by air vibrating the eardrum. The pitch of the sound is determined by how fast the vibrations are. For an adult human, the slowest vibration perceived as sound is about twenty times a second, which the brain interprets as a bass sound; the fastest is many thousands of times a second, which the brain interprets as a high treble sound.

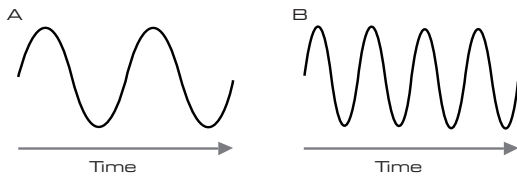

If the number of peaks in the two waveforms (vibrations) are counted, it will be seen that there are exactly twice as many peaks in Wave B as in Wave A. (Wave B is actually an octave higher in pitch than Wave A.) It is the number of vibrations in a given period that determines the pitch of a sound. This is the reason that pitch is sometimes referred to as frequency. It is the number of waveform peaks counted during a given period of time which defines the pitch, or frequency.

Tone

Musical sounds consist of several different, related pitches occurring simultaneously. The lowest is referred to as the 'fundamental' pitch and corresponds to the perceived note of the sound. Other pitches making up the sound which are related to the fundamental in simple mathematical ratios are called harmonics. The relative loudness of each harmonic as compared to the loudness of the fundamental determines the overall tone or 'timbre' of the sound.

Consider two instruments such as a harpsichord and a piano playing the same note on the keyboard and at equal volume. Despite having the same volume and pitch, the instruments still sound distinctly different. This is because the different note-making mechanisms of the two instruments generate different sets of harmonics; the harmonics present in a piano sound are different to those found in a harpsichord sound.

Volume

Volume, which is often referred to as the amplitude or loudness of the sound, is determined by how large the vibrations are. Very simply, listening to a piano from a metre away would sound louder than if it were fifty metres away.



Having shown that just three elements may define any sound, these elements now have to be realised in a musical synthesiser. It is logical that different sections of the synthesiser 'synthesize' (or create) each of these different elements.

One section of the synthesiser, the **Oscillators**, provide raw waveform signals which define the pitch of the sound along with its raw harmonic content (tone). These signals are then mixed together in a section called the **Mixer**, and the resulting mixture is then fed into a section called the **Filter**. This makes further alterations to the tone of the sound, by removing (filtering) or enhancing certain of the harmonics. Lastly, the filtered signal is fed into the **Amplifier**, which determines the final volume of the sound.

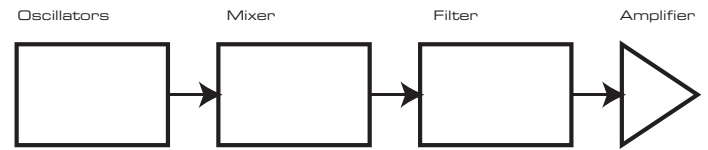

Additional synthesiser sections - **LFOs** and **Envelopes** - provide further ways of altering the pitch, tone and volume of a sound by interacting with the **Oscillators**, **Filter** and **Amplifier**, providing changes in the character of the sound which can evolve over time. Because **LFOs**' and **Envelopes**' only purpose is to control (modulate) the other synthesiser sections, they are commonly known as 'modulators'.

These various synthesiser sections will now be covered in more detail.

The Oscillators And Mixer

The Oscillator section is really the heartbeat of the synthesiser. It generates an electronic wave (which creates the vibrations when eventually fed to a loudspeaker). This waveform is produced at a controllable musical pitch, initially determined by the note played on the keyboard or contained in a received MIDI note message. The distinctive tone or timbre of the waveform is actually determined by the waveform's shape.

Many years ago, pioneers of musical synthesis discovered that just a few distinctive waveforms contained many of the most useful harmonics for making musical sounds. The names of these waves reflect their actual shape when viewed on an instrument called an oscilloscope, and they are: Sine waves, Square waves, Sawtooth waves, Triangle waves and Noise. Each of Peak's Oscillator sections can generate all these waveforms, and can generate non-traditional synth waveforms as well. (Note that Noise is actually generated independently and mixed in with the other waveforms in the Mixer section.)

Each waveform (except Noise) has a specific set of musically-related harmonics which can be manipulated by further sections of the synthesiser.

The diagrams below show how these waveforms look on an oscilloscope, and illustrate the relative levels of their harmonics. Remember, it is the relative levels of the various harmonics present in a waveform which determine the tonal character of the final sound.

Sine Waves



These possess just one harmonic. A sine waveform produces the "purest" sound because it only has this single pitch (frequency).

Triangle Waves



These contain only odd harmonics. The volume of each decreases as the square of its position in the harmonic series. For example, the 5th harmonic has a volume 1/25th of the volume of the fundamental.

Sawtooth Waves

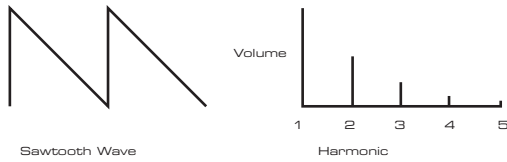

These are rich in harmonics, and contain both even and odd harmonics of the fundamental frequency. The volume of each is inversely proportional to its position in the harmonic series.

Square / Pulse Waves

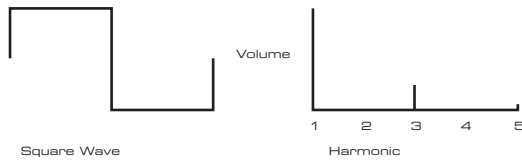

These contain only odd harmonics, which are at the same volume as the odd harmonics in a sawtooth wave.

It will be noticed that the square waveform spends an equal amount of time in its 'high' state as in its 'low' state. This ratio is known as the 'duty cycle'. A square wave always has a duty cycle of 50% which means it is 'high' for half the cycle and 'low' for the other half. Peak lets you adjust the duty cycle of the basic square waveform (via the **Shape Amount** control) to produce a waveform which is more 'rectangular' in shape. These are often known as Pulse waveforms. As the waveform becomes more and more rectangular, more even harmonics are introduced and the waveform changes its character, becoming more 'nasal' sounding.

The width of the pulse waveform (the 'Pulse Width') can be altered dynamically by a modulator, which results in the harmonic content of the waveform constantly changing. This can give the waveform a very 'fat' quality when the pulse width is altered at a moderate rate.

A pulse waveform sounds the same whether the duty cycle is – for example – 40% or 60%, since the waveform is just "inverted" and the harmonic content is exactly the same.

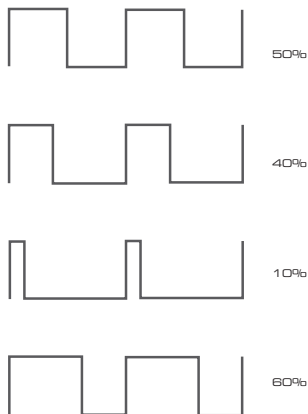

Noise

Noise is basically a random signal, and does not have a fundamental frequency (and therefore has no pitch property). Noise contains all frequencies, and all are at the same volume. Because it possesses no pitch, noise is often useful for creating sound effects and percussion type sounds.



Ring Modulation

A Ring Modulator is a sound generator that takes signals from two oscillators and effectively "multiplies" them together. Peak's Ring Modulator uses Oscillator 1 and Oscillator 2 as inputs. The resulting output depends on the various frequencies and

harmonic content present in each of the two oscillator signals, and will consist of a series of sum and difference frequencies as well as the frequencies present in the original signals.

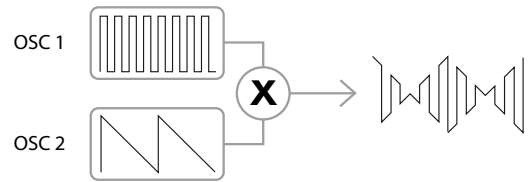

The Mixer

To extend the range of sounds that may be produced, typical analogue synthesisers have more than one Oscillator (Peak has three). By using multiple Oscillators to create a sound, it is possible to achieve very interesting harmonic mixes. It is also possible to slightly detune individual Oscillators against each other, which creates a very warm, 'fat' sound. Peak's Mixer allows you to create a sound consisting of the waveforms of Oscillators 1, 2 and 3, a Noise source and the Ring Modulator output, all mixed together as required.

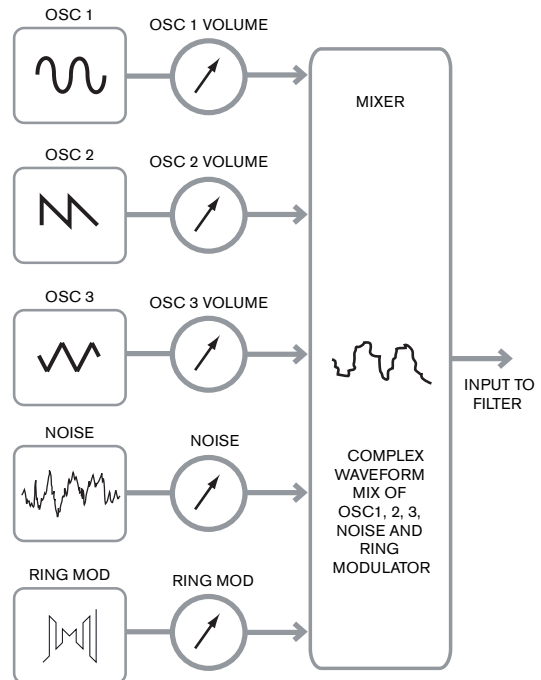

The Filter

Peak is a *subtractive* music synthesiser. *Subtractive* implies that part of the sound is subtracted somewhere in the synthesis process.

The Oscillators provide the raw waveforms with plenty of harmonic content and the Filter section subtracts some of the harmonics in a controlled manner.

There are three basic filter types, all of which are available in Peak: low-pass, band-pass and high-pass. The type of filter most commonly used on synthesisers is low-pass. In a low-pass filter, a "cut-off frequency" is chosen and any frequencies below this are passed, while frequencies above are filtered out, or removed. The setting of the **Filter Frequency** parameter dictates the point above which frequencies are removed. This process of removing harmonics from the waveforms has the effect of changing the sound's character or timbre. When the Frequency parameter is at maximum, the filter is completely "open" and no frequencies are removed from the raw Oscillator waveforms.

In practice, there is a gradual (rather than a sudden) reduction in the volume of the harmonics above the cut-off point of a low-pass filter. How rapidly these harmonics reduce in volume as frequency increases above the cut-off point is determined by the filter's **Slope** parameter. The slope is measured in 'volume units per octave'. Since volume is measured in decibels, this slope is usually quoted as so many decibels per octave (dB/oct). The higher the number, the greater the rejection of harmonics above the cut-off point, and the more pronounced the filtering effect. Peak's filter section provides two slopes, 12 dB/oct and 24 dB/oct.

A further important parameter of the filter is Resonance. Frequencies at the cut-off point may be increased in volume by advancing the filter's **Resonance** control. This is useful for emphasising certain harmonics of the sound.

As Resonance is increased, a whistling-like quality will be introduced to the sound passing through the filter. When set to very high levels, Resonance actually causes the filter to self-oscillate whenever a signal is being passed through it. The resulting whistling tone

being produced is actually a pure sine wave, the pitch of which depends on the setting of the **Frequency** control (the filter's cut-off point). This resonance-produced sine wave can actually be used for some sounds as an additional sound source if wished.

The diagram below shows the response of a typical low-pass filter. Frequencies above the cut-off point are reduced in volume.

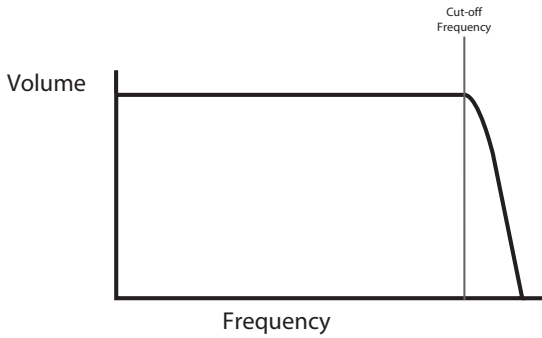

When resonance is added, the frequencies around the cut off point are boosted in volume.

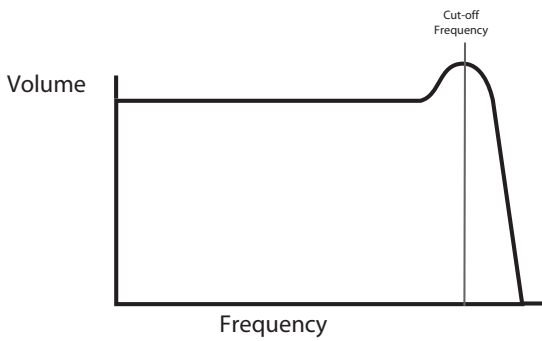

In addition to the traditional low-pass filter type, there are also high-pass and band-pass types. On Peak, the filter type is selected with the **Shape** switch [33](#).

A high-pass filter is similar to a low-pass filter, but works in the "opposite sense", so that it is frequencies below the cut-off point which are removed. Frequencies above the cut-off point are passed. When the **Frequency** parameter is set to minimum, the filter is completely open and no frequencies are removed from the raw Oscillator waveforms.

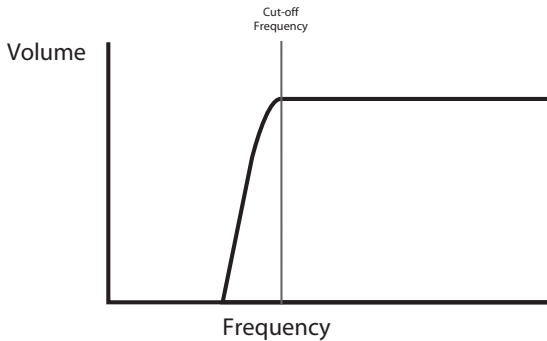

With a band-pass filter, just a narrow band of frequencies centered around the cut-off point is passed. Frequencies above and below the band are removed. It is not possible to fully open this type of filter and allow all frequencies to pass.

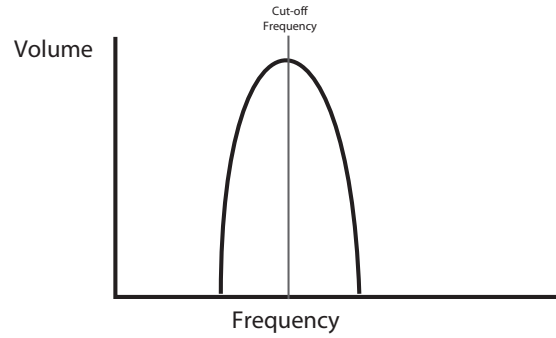

Envelopes And Amplifier

In earlier paragraphs, the synthesis of the pitch and the timbre of a sound was described. The next part of the Synthesis Tutorial describes how the volume of the sound is controlled. The volume of a note created by a musical instrument often varies greatly over the duration of the note, according to the type of instrument.

For example, a note played on an organ quickly attains full volume when a key is pressed. It stays at full volume until the key is released, at which point the volume level falls instantly to zero.

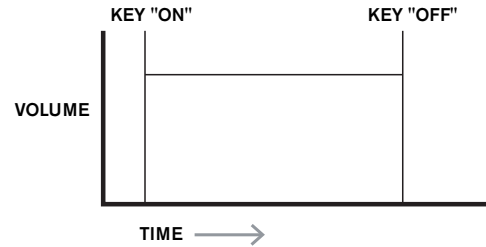

A piano note quickly attains full volume after a key is pressed, but gradually falls in volume to zero after several seconds, even if the key is held.

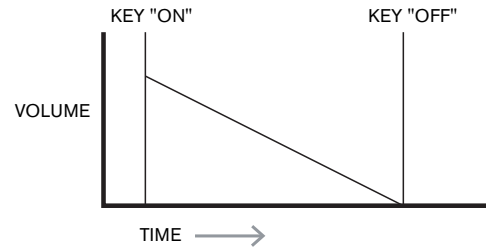

A string section emulation only attains full volume gradually when a key is pressed. It remains at full volume while the key is held down, but once the key is released, the volume falls to zero fairly slowly.

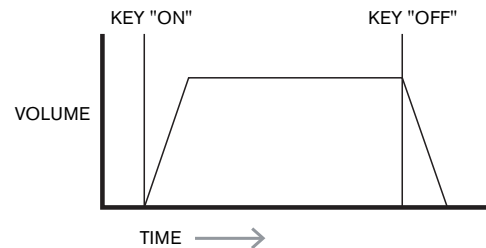

In an analogue synthesiser, changes to a sound's character which occur over the duration of a note are controlled by a section called an Envelope Generator. One (**Amp Env**) is always related to the Amplifier, which controls the note's amplitude – i.e., the volume of the sound – when the note is played. Each envelope generator has four main parameters, which determine the shape of the envelope; these are often referred to as the ADSR parameters.

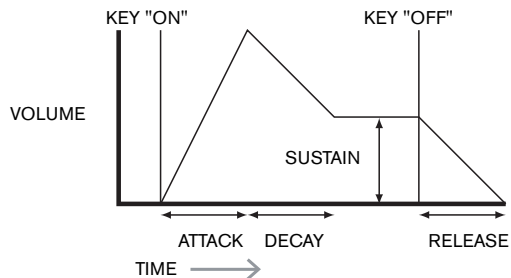

Attack Time

Adjusts the time it takes after a key is pressed for the volume to climb from zero to full volume. It can be used to create a sound with a slow fade-in.

Decay Time

Adjusts the time it takes for the volume to fall from its initial full volume to the level set by the Sustain control while a key is held down.

Sustain Level

This is unlike the other Envelope controls in that it sets a level rather than a period of time. It sets the volume level that the envelope remains at while the key is held down, after the Decay Time has expired.

Release Time

Adjusts the time it takes for the volume to fall from the Sustain level to zero once the key is released. It can be used to create sounds that have a "fade-out" quality.

Most synthesisers can generate multiple envelopes. Peak has three Envelope Generators: **Amp Env** has a dedicated set of ADSR controls, and is always applied to the amplifier to shape the volume of each note played, as detailed above. The two Modulation Envelopes (**Mod Env 1** and **Mod Env 2**) share an identical set of controls, with an assignment switch selecting the envelope being controlled. Modulation envelopes can be used to dynamically alter other sections of the synthesiser during the lifetime of each note. Peak's **Mod Env** Generators can be used to modify the filter cut-off frequency, or the pulse width of the Oscillators' Square Wave outputs, for example.

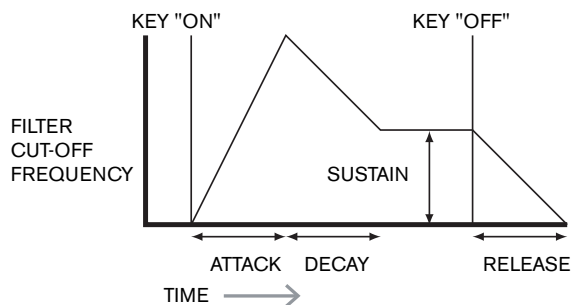

LFOs

Like the Envelope Generators, the LFO (Low Frequency Oscillator) section of a synthesiser is a Modulator. Thus instead of being a part of the sound synthesis itself, it is used to change (or modulate) other sections of the synthesiser. In Peak, for example, the LFOs can be used to alter Oscillator pitch, or Filter cutoff frequency.

Most musical instruments produce sounds that vary over time both in volume and in pitch and timbre. Sometimes these variations can be quite subtle, but still contribute greatly towards characterising the final sound.

Whereas an Envelope is used to control a one-off modulation over the lifetime of a single note, LFOs modulate by using a repeating cyclic waveform or pattern. As discussed earlier, Oscillators produce a constant waveform, which can take the shape of a repeating sine wave, triangle wave etc. LFOs produce waveforms in a similar way, but normally at a frequency which is too low to produce a sound that the human ear could perceive directly. As with an Envelope, the waveforms generated by the LFOs may be fed to other parts of the synthesiser to create the desired changes over time – or 'movements' - to the sound. Peak has two independent LFOs, which may be used to modulate different synthesiser sections and can run at different speeds.

Imagine this very low frequency wave being applied to an Oscillator's pitch. The result is that the pitch of the Oscillator slowly rises and falls above and below its original pitch. This would simulate, for example, a violinist moving a finger up and down the string of the instrument whilst it is being bowed. This subtle up and down movement of pitch is referred to as the 'Vibrato' effect.

A waveshape often used for an LFO is a Triangle wave.

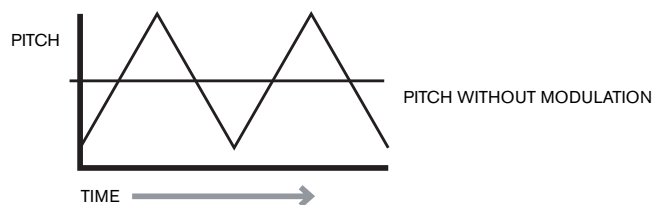

Alternatively, if the same LFO signal were to modulate the Filter cut-off frequency instead of the Oscillator pitch, a familiar wobbling effect known as 'wah-wah' would be the result.

Summary

A synthesiser can be broken down into five main sound generating or sound modifying (modulating) blocks:

1. Oscillators that generate waveforms at a various pitches.
2. A Mixer that mixes the outputs from the Oscillators together (and add Noise and other signals).
3. Filters that remove certain harmonics, changing the character or timbre of the sound.
4. An Amplifier controlled by an Envelope generator, which alters the volume of a sound over time when a note is played.
5. LFOs and Envelopes that can be used to modulate any of the above.

Much of the enjoyment to be had with a synthesiser is with experimenting with the factory preset sounds (Patches) and creating new ones. There is no substitute for 'hands on' experience. Experiments with adjusting Peak's various controls will eventually lead to a fuller understanding of how the various synth sections alter and help shape new sounds. Armed with the knowledge in this chapter, and an understanding of what is actually happening in the synth when tweaks to the knobs and switches are made, the process of creating new and exciting sounds will become easy. Have fun!

PEAK: SIMPLIFIED BLOCK DIAGRAM

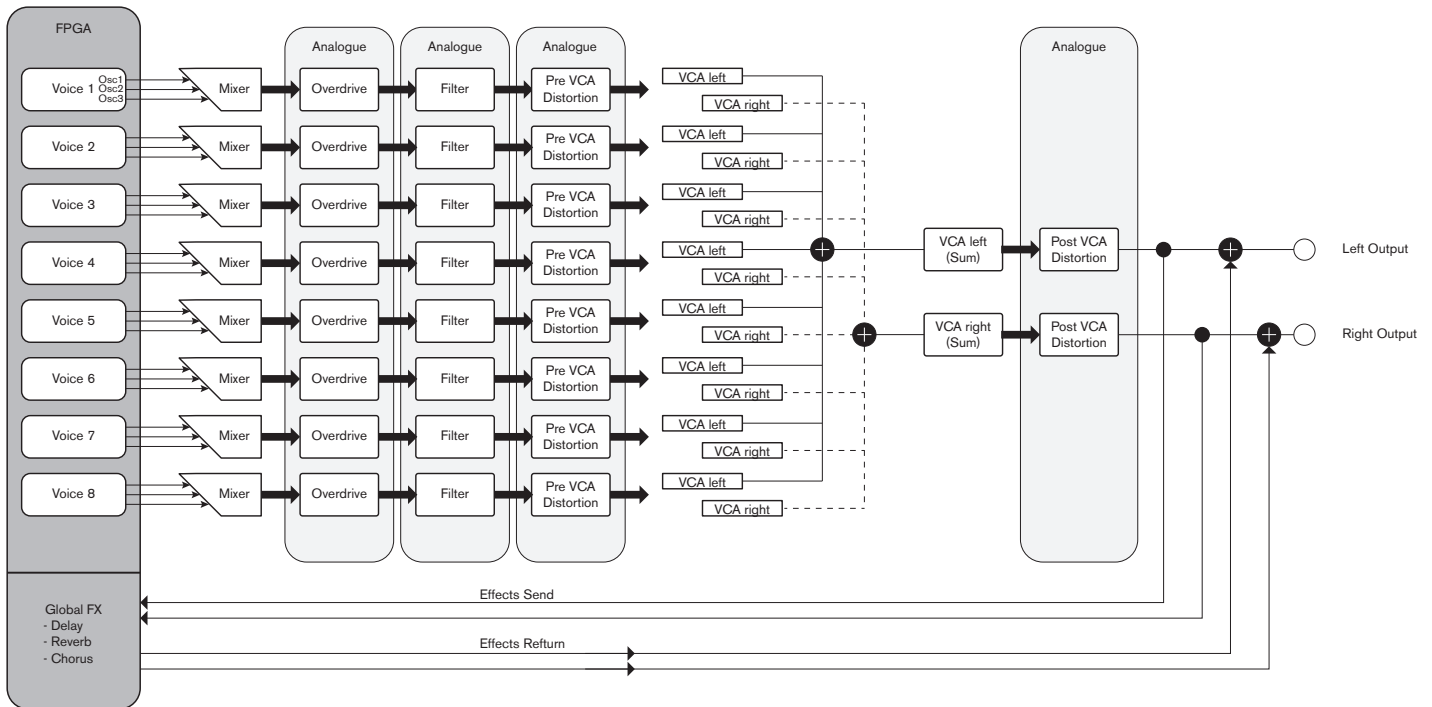

Peak has eight separate voices, which are treated independently throughout the remaining signal chain. The voices are synthesised digitally in a Field Programmable Gate Array (FPGA) using Numerically Controlled Oscillators running at an extremely high clock rate, resulting in waveforms which are indistinguishable from those using traditional analogue synthesis.

Each voice is a mix of the outputs of the three oscillators; when you adjust one of the oscillator level controls [19], [20] or [21] you are effectively adjusting the level of eight voices simultaneously. The subsequent elements in the signal processing chain are entirely in the analogue domain. Note that distortion can be added in several places – before the filter (**Overdrive** [37]), after the filter (**Filter Post Drive** in the Voices Menu) and after final voice summation (**Distortion Level** [43]). The sonic effect can be quite different in each case.

Note that the time-domain effects (FX) – chorus, delay and reverb – are digitally generated within the FPGA as well. The stereo effects send into the FX processing section is taken from post the main VCA, so all distortions added to the signals are processed by the FX. The FX return signal is added back to same point in the signal path.

PEAK IN DETAIL

In this section of the manual, each section of the synthesiser is discussed in greater detail. The sections are arranged in order of “signal flow” – see the Block Diagram above. Within each section, the surface physical controls are described first, followed by a reference guide to the display menu relating to the section. In general, the menus offer “fine control” parameters to which access is less readily required. The “initial value” given for each parameter is that for the factory Init Patch: these will differ when another Patch is loaded.

We must emphasise that there is no substitute for experimentation. Adjusting controls and tweaking individual parameters while listening to different Patches will tell you more about what each parameter does than this User Guide ever could. In particular, we would encourage you to experiment with the effect that varying a parameter has on different Patches – you will find there can be considerable differences between Patches, depending on how the sound is being generated.

The Oscillator Section

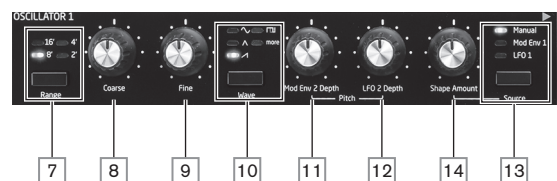

Peak's Oscillator section consists of three identical oscillators, each with its own set of controls. The following descriptions thus apply equally to any of the oscillators.

Wave

The Wave button [10] selects one of five wave shape options: four are the common fundamental waves, ~ Sine, ^ Triangle, / (rising) Sawtooth and □ Square/Pulse. The fifth option, **more**, allows selection from a range of 17 further wavetables, accessed via the WaveMore parameter in the Oscillator menu (see page 18). The LEDs confirm the waveform currently selected.

Pitch

The three controls **Range** [7], **Coarse** [8] and **Fine** [9] set the Oscillator's fundamental frequency (or Pitch). The **Range** button selects traditional "organ-stop" units, where 16' gives the lowest frequency and 2' the highest. Each doubling of stop length halves the frequency and thus transposes the pitch of a note played at the same position on a keyboard down one octave. When **Range** is set to 8', the keyboard will be at concert pitch with Middle C in the centre. The LEDs confirm the stop length currently selected.

The **Coarse** and **Fine** rotary controls adjust the pitch over a range of ± 1 octave and ± 1 semitone respectively. The OLED display shows the parameter value for **Coarse** in semitones (12 semitones = 1 octave) and **Fine** in cents (100 cents = 1 semitone).

Pitch Modulation

The frequency of each Oscillator may be varied by modulating it with either (or both) LFO 2 or the Mod Env 2 envelope. The two **Pitch** controls, **Mod Env 2 Depth** [11] and **LFO 2 Depth** [12] control the depth – or intensity – of the respective modulation sources.

Note that each Oscillator has a Depth control for modulation by LFO 2. It is also possible to modulate all three Oscillators simultaneously by LFO 1: this patch is set up in the Mod Matrix – see page 26. Oscillator pitch can be varied by up to five octaves, but the LFO 2 depth control is calibrated to give finer resolution at lower parameter values (less than ± 12), as these are generally more useful for musical purposes.

Negative values of **LFO 2 Depth** "invert" the modulating LFO waveform; the effect of this will be more obvious with non-sinusoidal LFO waveforms.

Adding LFO Modulation can add a pleasing vibrato when a sine or triangle LFO waveform is used, and the LFO speed is set neither too high nor too low. A sawtooth or square LFO waveform will produce rather more dramatic and unusual effects.

Adding envelope modulation can give some interesting effects, with the oscillator pitch altering over the duration of the note as it is played. With the parameter value set to maximum (± 127), the oscillator pitch will vary over eight octaves. A parameter value of 8 shifts the pitch by one octave at the maximum level of the modulation envelope (e.g., if sustain is at maximum). Negative values invert the sense of the pitch variation; i.e., the pitch will fall during the attack phase of the envelope if **Mod Env depth** has a negative setting.

Shape

Peak lets you modify the "shape" of the selected waveform; this will alter the harmonic content and thus the timbre of generated sound. The degree of modification – or deviation from the "classic" waveform type – can be varied both manually and as a modulation. The modulation sources available using the panel controls are Mod Env 1 and LFO 1; many other mod sources may be selected using the Modulation Matrix – see page 26.

The **Source** button [13] assigns the **Shape Amount** control [14] to one of the sources. When set to **Manual**, **Shape Amount** lets you alter the waveform shape directly; the parameter range is -63 to +63, where 0 corresponds to an unmodified waveform. The precise effect of **Shape Amount** will depend on the waveform in use.

When Sine is selected as the waveform, a non-zero **Shape Amount** parameter will add distortion, resulting in the addition of upper harmonics. Similarly, varying **Shape Amount** with Triangle or Sawtooth waveforms modifies wave shape and thus the harmonic content.

When Square/Pulse is selected as the waveform, **Shape Amount** will vary the pulse width: a value of 0 produces a 1:1 square wave. The timbre of the "edgy" square wave sound can be modified by varying the pulse width, or duty cycle, of the waveform. Extreme clockwise and anticlockwise settings produce very narrow positive or negative pulses, with the sound becoming thinner and more "reechy" as the control is advanced.

When the waveform is set to **more**, **Shape Amount** selects the waveform by sweeping across the five columns in the selected wavetable to produce a "morphing" of two adjacent columns: the sonic effect of this will vary greatly depending on the active patch and the wavetable in use. We recommend you experiment altering **Shape Amount** with different waveforms to hear the effect.

Shape may also be modulated by either (or both) Mod Env 1 or LFO 1, as selected by **Source** [13]. With pulse waveforms, the sonic effect of LFO modulation is very dependent on the LFO waveform and speed used, while using envelope modulation can produce some good tonal effects, with the harmonic content of the note changing over its duration.

The Oscillator Menu

The following additional Oscillator parameters are available in the **Osc** menu. Each of the three oscillators has two menu pages; the parameters available for each oscillator are identical. There are also two further pages (Pages 1/8 and 2/8), with parameters common to all three oscillators.

Per-Oscillator pages:

The default menu displays for Oscillator 1 are shown below:

```
OSCILLATOR 1      3/8
WaveMore         BS sine ▶
FixedNote        Off
BendRange        +12
```

```
OSCILLATOR 1      4/8
Usync            0 ▶
SawDense         0
DenseDet         64
```

More Waveforms

Displayed as: WaveMore
Initial value: BS sine
Range of adjustment: Wide range of waveforms

Peak includes a wavetable of 17 x 5 waveforms. The WaveMore parameter selects the row of the wavetable the oscillator uses when **Wave** [10] is set to **more**. Note that the wavetable column (or pair of adjacent columns) in use is determined by the setting of **Shape Amount** [14].

Single Fixed Note

Displayed as: FixNote
Initial value: Off
Range of adjustment: Off, C# -2 to E 5

Some sounds need not be chromatically-dependent. Examples would be certain percussion sounds (e.g., bass drums), and sound effects, such as a laser gun. It is possible to assign a fixed note to a patch, such that playing any key on the keyboard generates the same sound. The pitch on which the sound is based may be any semitone note in a range of over eight octaves. With the parameter set **Off**, the keyboard behaves as normal. With it set to any other value, every key plays the sound at the pitch corresponding to the value.

Pitch Wheel Range

Displayed as: BendRange
Initial value: +12
Range of adjustment: -24 to +24

A keyboard pitch wheel can vary the oscillator pitch by up to two octaves, up or down. The units are in semitones, so with the default value of +12, moving the pitch wheel up increases the pitch of the notes being played by one octave, and moving it down takes them down an octave. Setting the parameter to a negative value has the effect of reversing the operating sense of the pitch wheel. You will find that many of the factory Patches have this parameter set to +12 to allow a pitch wheel range of ± 1 octave, or to +2 for a range of ± 1 tone.

Oscillator Sync

Displayed as: `VSync`
 Initial value: 0
 Range of adjustment: 0 to 127

Oscillator Sync is traditionally a technique of using one oscillator (the master) to add harmonics to another (the slave). Peak provides Oscillator Sync by using a virtual oscillator for each of the three main oscillators. The virtual oscillators are not heard, but the frequency of each is used to re-trigger that of the main oscillator. The `VSync` parameter controls the frequency offset of the virtual oscillator relative to the (audible) main oscillator. This technique produces an interesting range of sonic effects. The nature of the resulting sound varies as the parameter value is altered because the virtual oscillator frequency increases in proportion to the main oscillator frequency as the parameter value increases. When the `VSync` value is a multiple of 16, the virtual oscillator frequency is a musical harmonic of the main oscillator frequency. The overall effect is a transposition of the oscillator that moves up the harmonic series, with values in between multiples of 16 producing more discordant effects.

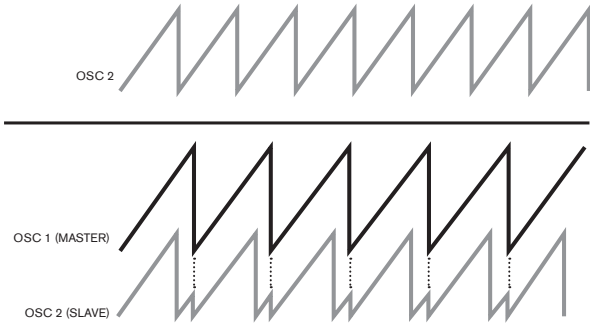

Common Oscillator page:

The default menu display is shown below:

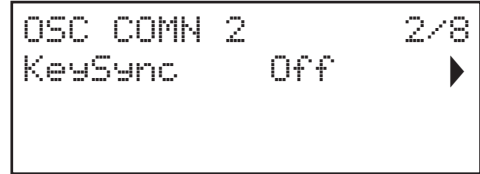
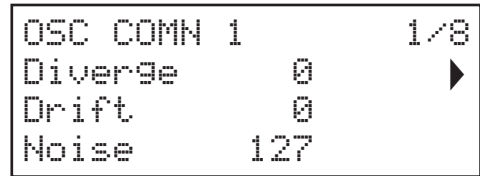

Diverge

Displayed as: `Diverge`
 Initial value: 0
 Range of adjustment: 0 to 127

Peak is an eight-voice synth, and each voice has three oscillators. Diverge applies very small pitch variations independently to each of these 24 oscillators. The effect of applying this is that each voice will have its own tuning characteristic. This adds a further interesting colouration to the sound quality and can be used to bring the synth alive. The parameter sets the degree of variation.

Oscillator Drift

Displayed as: `Drift`
 Initial value: 0
 Range of adjustment: 0 to 127

Peak has a dedicated very low frequency oscillator which can be used to apply a very slight meandering detune to the three Oscillators. This is to emulate the oscillator drift of traditional analogue synths: by applying a controlled amount of detuning, the oscillators become slightly out of tune with each other, adding a "fuller" character to the sound. Unlike Diverge, the drift effect changes over time.

Noise filter

Displayed as: `NoiseLFF`
 Initial value: 127
 Range of adjustment: 0 to 127

In addition to the three Oscillators, Peak also has a noise generator. Noise is a signal comprising a wide range of frequencies, and is a familiar "hissing" sound. The Noise filter is a low-pass type: restricting the bandwidth of the noise alters the characteristic of the "hiss", and you can adjusting the filter cut-off frequency to do this. The parameter's default value of 127 sets the filter "fully open". Note that the noise generator has its own input to the mixer, and in order to hear it in isolation, its input will need to be turned up and the oscillator inputs turned down. (See "The Mixer Section" on page 22.)

Key Sync

Displayed as: `KeySync`
 Initial value: Off
 Range of adjustment: Off or On

With `KeySync` set Off, Peak's three oscillators are free-running and even when set accurately to the same pitch, may not be in phase with each other. This often does not matter, but if the Ring Modulator is in use, the out-of-phase effect may not produce the result required. To overcome this, `KeySync` may be selected to On, which ensures that the oscillators always start generating their waveforms at the start of a cycle when a key is pressed.

t Vsync may be controlled for any or all oscillators using the Modulation Matrix. See "The Modulation Matrix" on page 26 for details of how to use the Matrix.

t To get the best out of Vsync, try modulating it using the LFO. Try assigning it to the MOD wheel for real-time control.

Sawtooth Density

Displayed as: `SawDense`
 Initial value: 0
 Range of adjustment: 0 to 127

This parameter only affects sawtooth waveforms. It effectively adds copies of the oscillator waveform to itself. Two additional virtual oscillators are used for this, producing a "thicker" sound at low to medium values, but if the virtual oscillators are detuned slightly (see Density Detuning below), a more interesting effect is obtained.

Density Detuning

Displayed as: `DenseDet`
 Initial value: 64
 Range of adjustment: 0 to 127

This parameter should be used in conjunction with Sawtooth Density. It detunes the virtual density oscillators, and you will notice not only a thicker sound, but the effect of beating as well.

t Sawtooth Density and Density Detuning parameters can be used to "thicken" the sound, and simulate the effect of adding additional Voices. The Unison and Unison Detune parameters in the Voice Menu can be used to create a very similar effect, but using Density and Density Detune have the advantage of not needing to use additional Voices, which are finite in number.

The LFO Section

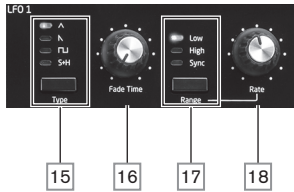

Peak has two Low Frequency Oscillators (LFOs), LFO 1, and LFO 2. They are identical in terms of features, but their outputs may be routed using the panel controls to different parts of the synth and are thus used differently, as outlined below:

LFO 1:

- can modify the waveform shape of each oscillator when LFO1 is selected by the oscillator's **Source** button [13];
- can modulate the filter frequency; the amount of modulation is adjusted in the Filter Section with **LFO 1 Depth** control [40].

LFO 2:

- can modulate the pitch of each Oscillator; the amount of modulation is adjusted in the Oscillator Section with the **LFO 2 Depth** control [12]. This is the method of adding "vibrato" to a sound.

Either LFO may additionally be patched in the Modulation Matrix (see page 26) to modulate many other synth parameters.

LFO Waveform

The Type button [15] selects one of four wave shapes - Δ Triangle, \slopedownarrow (falling) Sawtooth, Square or \square Sample and Hold. The LEDs above the button confirm the waveform currently selected.

LFO Rate

The speed (or frequency) of each LFO is set by the **Range** button [7] and the rotary **Rate** control [18]. The **Range** button has three settings: High, Low and Sync. The LFO frequency ranges are from 0 to 200 Hz in the Low setting and 0 to 1.6 kHz in High. Selecting Sync reassigns the function of the **Rate** control, and allows the speed of the LFO to be synchronised to an internal or external MIDI clock, based on a sync value selected by the control. When Sync is selected, the OLED displays the **RateSync** parameter, which allows you to choose the tempo division required with the **Rate** control. See LFO Sync Rate table on page 36.

LFO Fade Time

LFO effects are often more effective when faded-in, rather than just 'switched on'; the **Fade Time** parameter sets how long the LFO output takes to ramp up when a note is played. The rotary control [16] is used to adjust this time. See also Fade Mode (page 21), where you can also make the LFO fade out after the Fade Time, or, start or end abruptly after the Fade Time.

The LFO Menu

Each of Peak's LFOs are 'per voice'. This is a very powerful feature of Peak (and other Novation synthesisers). For example, when an LFO is assigned to create vibrato, and a chord is played, each note of the chord will be varied at the same rate, but not necessarily at the same phase. There are various settings in the LFO Menu that control how the LFOs respond and lock together.

Each LFO has two menu pages; the parameters available for each LFO are identical.

The default menu displays for LFO 1 are shown below:

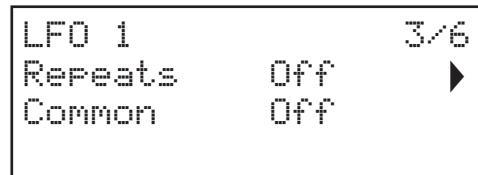
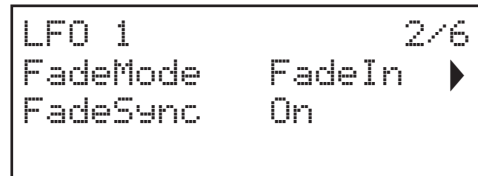
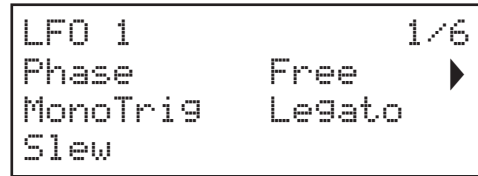

LFO Phase

Displayed as:	Phase
Initial value:	Free
Range of adjustment:	Free; 0deg to 357deg (in 3deg increments)

Each LFO runs continuously 'in the background'. If **Phase** is set to Free (the default), there is no way of predicting where the waveform will be when a key is pressed. Consecutive presses of a key will inevitably produce varying results. With all other values of **Phase**, the LFO will re-start at the same point on the waveform every time a key is pressed, the actual point being determined by the parameter value. A complete waveform has 360°, and the control's increments are in 3° steps. Thus a half-way setting (180deg) will cause the modulating waveform to start at half-way through its cycle.

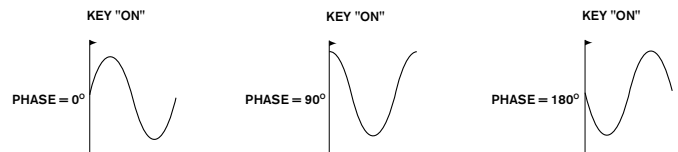

MonoTrig

Displayed as:	MonoTrig
Initial value:	Legato
Range of adjustment:	Legato or Re-Trig

MonoTrig only applies to monophonic Voice modes (see "Voices" on page 27).

Providing that **LFO Phase** is not set to Free, the LFOs are re-triggered each time a new note is pressed. But if you are playing in legato style (literally "smoothly" – playing further keys while one key is still held), the LFOs will only re-trigger if **MonoTrig** is set to Re-Trig. If set to Legato, you will only hear the effect of re-triggering on the first note.

LFO Slew

Displayed as: SLEW
Initial value: 0
Range of adjustment: 0 to 127

Slew has the effect of modifying the shape of the LFO waveform. Sharp edges become less sharp as Slew is increased. The effect of this can be heard on pitch modulation by selecting Square as the LFO waveform and setting the rate fairly low so that when a key is pressed the output alternates between just two tones. Increasing the value of SLEW will cause the transition between the two tones to become a "glide" rather than a sharp change. This is caused by the vertical edges of the square LFO waveform being slewed.

i

Note that SLEW has an effect on all LFO waveforms, but the sonic effect differs with waveform rate and type. As SLEW is increased, the time taken to reach maximum amplitude is increased, and can ultimately result in it never being achieved at all, though the setting at which this point is reached will vary with waveform.

SQUARE WAVE
NO SLEW

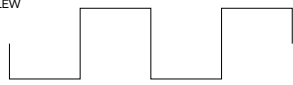

SMALL SLEW VALUE



LARGE SLEW VALUE



Fade Mode

Displayed as: FadeMode
Initial value: FadeIn
Range of adjustment: FadeIn, FadeOut, GateIn, GateOut

The function of the four possible settings of FadeMode are as follows:

1. **FadeIn** – the LFO's modulation is gradually increased over the time period set by the **Fade Time** control [16].
2. **FadeOut** – the LFO's modulation is gradually decreased over the time period set by the **Fade Time** control, leaving the note unmodulated.
3. **GateIn** – the onset of the LFO's modulation is delayed by the time period set by the **Fade Time** parameter, and then starts immediately at full level.
4. **GateOut** – the note is fully modulated by the LFO for the time period set by the **Fade Time** parameter. At this time, the modulation stops abruptly.

Note that whichever of the Fade Modes is selected is always active; if you do not want to hear its effect, turn the **Fade Time** control [16] down to zero.

LFO Fade Sync

Displayed as: FadeSync
Initial value: On
Range of adjustment: Off or On

The setting of FadeSync only applies to monophonic voice modes (see "Voices" on page 27). FadeSync determines whether the time delay set by **Fade Time** is re-started each time a key is pressed. With FadeSync set to On (the default), the LFO fade time recommences; when set to Off, it is triggered only by the first note. This will only be of relevance when playing in legato style.

Repeats

Displayed as: Repeats
Initial value: Off
Range of adjustment: Off, 1 - 127

REPEATS sets how many cycles of LFO waveform will be generated each time the LFO is triggered. So if set to 1, you will only hear the effect of any LFO modulation for a single cycle, and hence for a short duration (depending on the setting of **Rate**, of course).

LFO Common Sync

Displayed as: COMMON
Initial value: Off
Range of adjustment: Off or On

Common Sync is only applicable to polyphonic voices. When COMMON is On, it ensures that the phase of the LFO waveform is synchronised for every note being played. When set Off, there is no such synchronisation, and playing a second note while one is already pressed will result in an unsynchronised sound as the modulations will be out of time. When LFOs are in use for pitch modulation (their most common application), having COMMON set to Off will give more natural results.

KEY "ON"

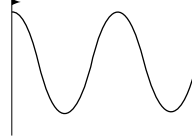

NOTE 1

KEY "ON"

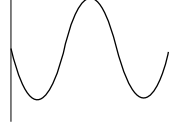

NOTE 2

KEY "ON"

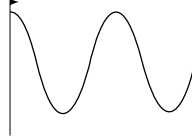

NOTE 1

KEY "ON"

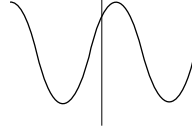

NOTE 2

t

Set COMMON to On for an emulation of early analogue polyphonic synths.

The Mixer Section

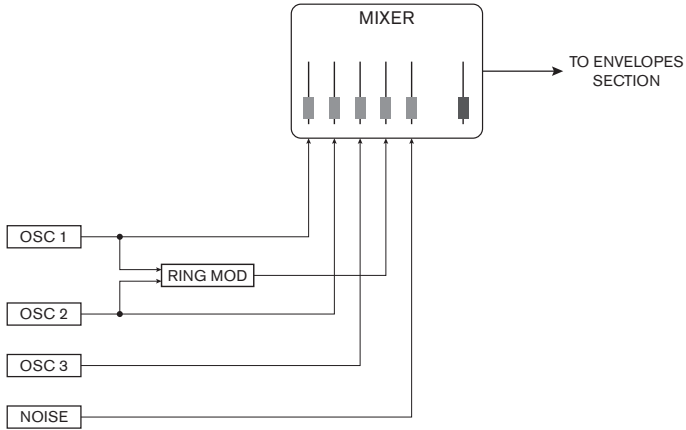
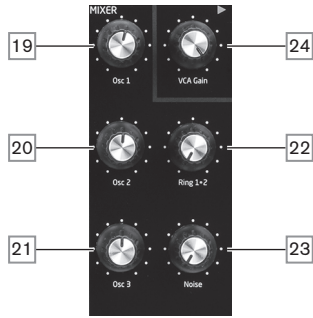

The outputs of the various sound sources can be mixed together in any proportion to produce the overall synth sound, using what is essentially a standard 5-into-1 mono mixer.

The three Oscillators, the Noise source and the Ring Modulator output each have level controls, **Osc 1** [19], **Osc 2** [20], **Osc 3** [21], **Noise** [23] and **Ring 1+2** [22] respectively. There is also a "master" level control, **VCA Gain** [24], which sets the output level of the mixer. As the mixer section precedes the Envelopes section, this control scales the ADSR envelope.



Peak is capable of producing levels in the mixer section that can clip if all sources are turned up to maximum. It may be necessary to balance the levels either by turning the sources down or by reducing the **VCA Gain** control [24] to ensure that audible clipping does not occur.

The Envelopes Section

Peak generates three envelopes each time a key is pressed, which can be used to modify the synth sound in many ways. The envelope controls are based on the familiar ADSR concept.

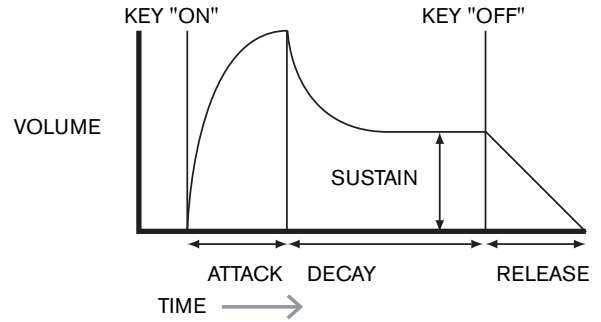

The ADSR envelope can be most easily visualised by considering the amplitude (volume) of a note over time. The envelope describing the "lifetime" of a note can be split into four distinct phases:

- **Attack** – the time it takes for the note to increase from zero (e.g., when the key is pressed) to its maximum level. A long attack time produces a "fade-in" effect.
- **Decay** – the time it takes for the note to drop in level from the maximum value reached at the end of the attack phase to a new level, defined by the Sustain parameter.
- **Sustain** – this is an amplitude value, and represents the volume of the note after the initial attack and decay phases – i.e., while holding the key down. Setting a low value of Sustain can give a very short, percussive effect (providing the attack and decay times are short).
- **Release** – This is the time it takes for the note's volume to drop back to zero after the key is released. A high value of Release will cause the sound to remain audible (though diminishing in volume) after the key is released.

Although the above discusses ADSR in terms of volume, note that Peak is equipped with three separate envelope generators, referred to as **Amp Envelope**, **Mod Envelope 1** and **Mod Envelope 2**.

- **Amp Env** is the envelope that controls the amplitude of the synth signal, and is always routed to the VCA in the output stage (see "PEAK: Simplified Block Diagram" on page 17). Peak also allows Amp Env to modulate the frequency of the Filter section.
- **Mod Env 1 & 2** – the two modulation envelopes - are routed to various other sections of Peak, where it can be used to alter other synth parameters over the duration of the note. They are:
 - Mod Env 1 can modulate the waveform shape of any of the three Oscillators, at a degree set by the **Shape Amount** controls [14] when the associated **Source** button [13] is set to Mod Env 1.
 - Mod Env 1 may also modulate the filter frequency, at a degree set by the **Env Depth** control [39] when the **Source** button [38] is set to Mod Env 1.
 - Mod Env 2 can modulate the pitch of any of the three Oscillators, at a degree set by the **Mod Env Depth 2** controls [11].

It should be noted that the above routings are only those available directly using Peak's top panel controls: many more routing options are available using the Modulation Matrix (see "The Modulation Matrix" on page 26).

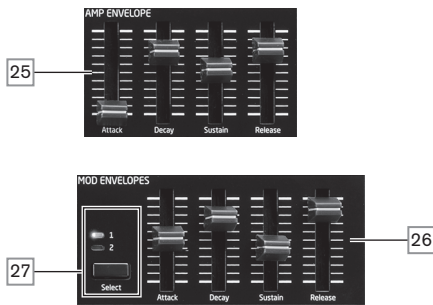

Peak's Envelope section has two sets of four slider controls, one set for **Amp Env**, the other for either **Mod Env 1** or **Mod Env 2**, as selected by the Select button [27](#). Each slider is dedicated to one of the ADSR parameters; the descriptions below describe the effect of the **Amp Envelope** controls as amplitude variations are more easily visualised, though the effect of the corresponding **Mod Envelope** controls is identical.

- **Attack** – sets the note's attack time. With the slider at its lowest position, the note attains its maximum level immediately the key is pressed; with the slider in its uppermost position, the note takes over 18 seconds to reach its maximum level.
- **Decay** – sets the time the note takes to decay from its initial level to that defined by the Sustain parameter. Maximum decay time is approx. 22 seconds.
- **Sustain** – sets the volume of the note after the decay phase. A low Sustain value will obviously have the effect of emphasising the start of the note; having the slider fully down will make the note inaudible when the decay time has elapsed.
- **Release** – Many sounds acquire some of their character from the notes remaining audible after the key is released; this "hanging" or "fade-out" effect, with the note gently dying away naturally (as with many real instruments) can be very effective. Peak has a maximum release time of over 24 seconds, but shorter times will probably be more useful! The relationship between the parameter value and the Release Time is not linear.

The Envelopes Menu

The following additional Envelope parameters are available in the **Env** menu. Each Envelope has two menu pages; the parameters available for each Envelope are identical, except that the initial value of the `MONOTRIG` parameter for the Mod Envelopes is Re-Trig.

The default menu displays for the Amp Envelope are shown below:

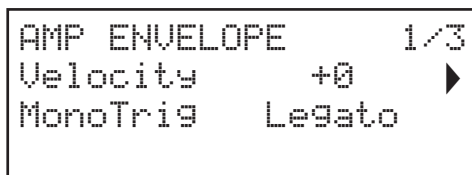

Velocity

Displayed as: Velocity
Initial value: 0
Range of adjustment: -64 to +63

`Velocity` does not modify the shape of the ADSR envelope in any way, but adds touch sensitivity to the sound. In the case of the Amplitude Envelope, setting a positive parameter value will mean the harder you play the keys, the louder will be the sound. If set to zero, the volume is the same regardless of how the keys are played. The relationship between the velocity at which a note is played and volume is determined by the value. Note that negative values have the inverse effect.

Multi-Triggering

Displayed as: `MONOTRIG`
Initial value: Legato
Range of adjustment: Legato or Re-Trig

When this parameter is set to Re-Trig, each note played will trigger its full ADSR envelope, even if other keys are held down. In Legato mode, only the first key to be pressed will produce a note with the full envelope, all subsequent notes will omit the attack and decay phases, and sound only from the start of the Sustain phase. "Legato" literally means "smoothly", and this mode aids this style of playing.

It is important to appreciate that for the Legato mode to be operative, `MONO` or `MONOLOG` modes must be selected in the Voice Menu – it will not work with polyphonic voicing or `MONO2` mode. See "Voices" on page 27.



What is Legato?

As implied above, the musical term Legato means "smoothly". A Legato keyboard style is one where at least two notes overlap. This means that as you play the melody, you keep the previous (or an earlier) note sounding as you play another note. Once that note is sounding, you then release the earlier note.



For the most "natural" playing style, try setting Amplitude Velocity to about +40.

The sonic effect of the corresponding Velocity parameter for the two Modulation Envelopes will depend on what the Envelopes are used for: for example, if they are used to modulate Filter Frequency (a common application), a positive Velocity parameter will result in a greater degree of filter action.

The Filter Section

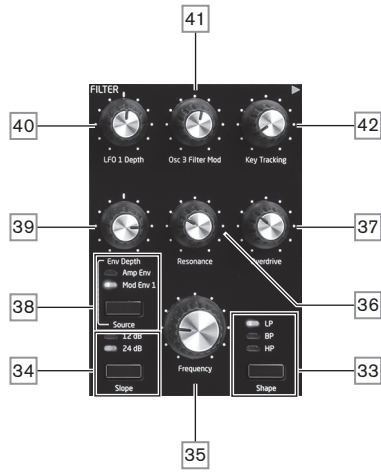

The sum of the various signal sources created in the mixer is fed to the Filter Section, which can be used to modify the harmonic content of the Oscillator's output. Peak's filter is a traditional analogue design, and has an extensive set of modulation and control options.

Filter type

The **Shape** button [33](#) selects one of three filter types: low-pass (**LP**), band-pass (**BP**) or high-pass (**HP**).

The **Slope** button [34](#) sets the degree of rejection applied to out-of-band frequencies; the **24 dB** position gives a steeper slope than the **12 dB**; an out-of-band frequency will be attenuated more severely with the steeper setting.

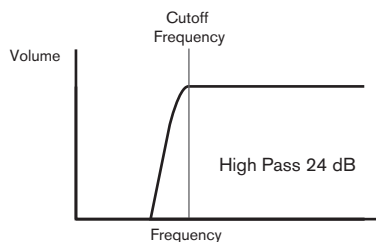
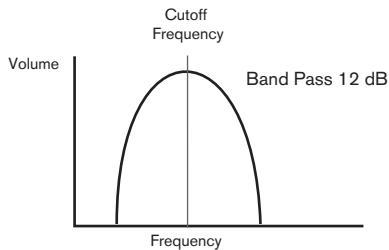
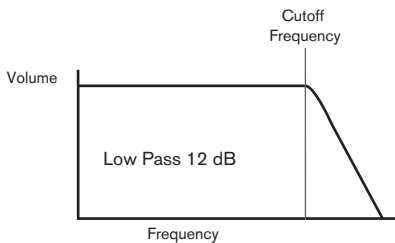
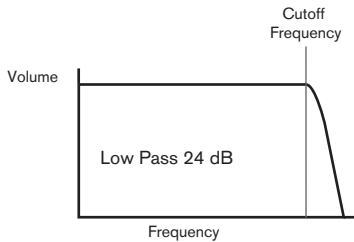

Frequency

The large rotary **Frequency** control [35](#) sets the cut-off frequency of the filter when **Shape** is set to **HP** or **LP**. With **BP** selected, **Frequency** sets the centre frequency of the filter's pass-band.

Sweeping the filter frequency manually will impose a "hard-to-soft" characteristic on almost any sound.

Resonance

The **Resonance** control [36](#) adds gain to the signal in a narrow band of frequencies around the frequency set by the **Frequency** control. It can accentuate the swept-filter effect considerably. Increasing the resonance parameter is very good for enhancing modulation of the cut-off frequency, creating a very edgy sound. Increasing **Resonance** also accentuates the action of the **Frequency** control, giving it a more pronounced effect.

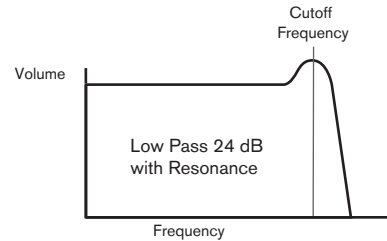

Setting **Resonance** to a high value can greatly increase the output signal level – the synth volume. This can be compensated for by adjusting **VCA Gain** [24](#).

Filter modulation

The filter's **Frequency** parameter may be modulated - using the physical controls - by the output of LFO 1, the Amplitude Envelope, Modulation Envelope 1, or any combination of these. Modulation by LFO 1 is controlled by the **LFO 1 depth** control [40](#), and by the **Env Depth** control [39](#) for either of the two envelopes. The **Env Depth** control is assigned to the Amplitude Envelope by selecting **Amp Env** with the **Source** button [38](#), and to Modulation Envelope 2 by selecting **Source** to **Mod Env**. Both mod sources may be used simultaneously, with the **Env Depth** control adjusting only the currently selected envelope. (Compare with the use of LFO 1 and Mod Env 1 for modulating the Oscillator's **Shape** parameter.)

As with many other control routings between synth sections, a great many more options for modulating the filter may be explored using the Modulation Matrix (see page 26).

Note that only one LFO – LFO 1 - is used for filter modulation. Filter frequency can be varied by up to eight octaves.

Negative values of **LFO 1** depth "invert" the modulating LFO waveform; the effect of this will be more obvious with non-sinusoidal LFO waveforms and low LFO rates.

Modulating the filter frequency with an LFO can produce some unusual "wah-wah" type effects. Setting LFO 1 to a very slow speed can add a gradual hardening and then softening edge to the sound.

When the filter's action is triggered by an envelope, the filter action changes over the duration of the note. By adjusting the Envelope controls carefully, this can produce some very pleasing sounds, as for example, the spectral content of the sound can be made to differ considerably during the attack phase of the note compared to its "fade-out".

Env depth lets you control the "depth" and "direction" of the modulation; the higher the value, the greater the range of frequencies over which the filter will sweep. Positive and negative values make the filter sweep in opposite directions, but the audible result of this will be further modified by the filter type in use.

Peak also allows direct modulation of the Filter frequency by Oscillator 3, to a degree controlled by **Osc 3 Filter Mod** [41](#). The intensity of the resulting effect is dependent on the control setting, but also on almost all Osc 3 parameters, e.g., range, pitch, waveform, pulse width and any modulation applied to the Oscillator.



Try adding Osc 3 Filter Mod while sweeping Osc 3 pitch with the pitch wheel.

Filter tracking

The pitch of the note played can be made to alter the cut-off frequency of the filter. This relationship is governed by the setting of the **Key Tracking** control [42]. At the maximum value (127), the filter cut-off frequency moves in semitone steps with the notes played on the keyboard – i.e., the filter tracks the pitch changes in a 1:1 ratio. This means that when playing two notes an octave apart, the filter cut off frequency will also change by one octave. At minimum setting (value 0), the filter frequency remains constant, whatever note(s) are played on the keyboard.



When using filter resonance as an additional oscillator, set **Key Tracking** to maximum (127) to allow the filter to be played 'in tune'.

Overdrive

The filter section includes a dedicated drive (or distortion) generator; the **Overdrive** control [37] adjusts the degree of distortion treatment applied to the signal. The drive is added before the filter.



Peak does not have a dedicated Filter menu, but two further Filter-related parameters – **Filter Post Drive** and **Filter Divergence** - are also available for adjustment in the Voice menu. See page 29.

The Modulation Matrix

The heart of a versatile synthesiser lies in the ability to interconnect the various controllers, sound generators and processing blocks such that one block is controlling – or “modulating” – another, in as many ways as possible. Peak provides considerable flexibility of control routing, and there is a dedicated menu for this, the **Mod** Menu. The available modulating sources and destinations to be modulated can be thought of as the inputs and outputs of a large matrix:

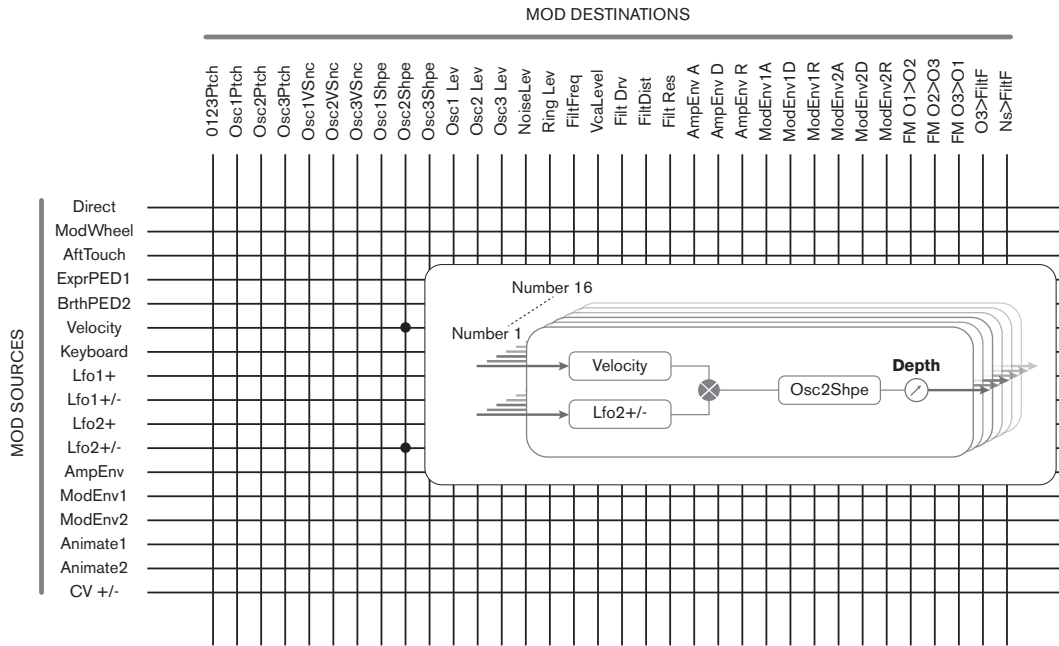

The example here shows how any two sources, in this case Velocity and LFO 2, can simultaneously modulate the same parameter, in this case Osc 2 Shape. Many mod matrix assignments will only use a single source. Note that the two modulation sources are effectively multiplied together, and that the Depth parameter controls the overall degree of modulation.

The diagram depicts a single matrix “slot”; Peak has 16 such slots, allowing an enormous range of modulation possibilities.

Press the **Mod** button [56] to open the Modulation Menu, which comprises two pages. The menu may be visualised as a system for connecting controlling sources to a specific area of the synth. Each such connection assignment is termed a ‘slot’, and there are 16 such slots, accessed on Page 1). Each slot defines how one or two control sources are routed to a controlled parameter. The routing possibilities available in each of the 16 slots are identical, and the control description below is applicable to all of them.

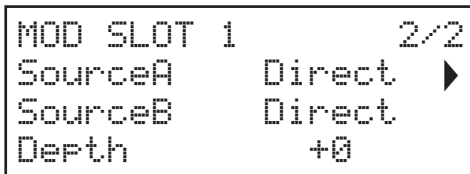
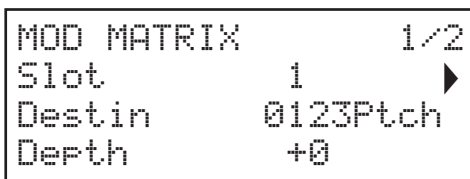

The Modulation Matrix is both variable and additive. What do we mean by a ‘variable’ and ‘additive’ matrix?

By ‘variable’, we mean that it is not just the routing of a controlling source to a controlled parameter which is defined in each slot, but also the “magnitude” of the control. Thus the ‘amount’ of control – or Depth – used is up to you.

By ‘additive’ we mean that a parameter may be varied by more than one source, if wished. Each slot allows for two sources to be routed to a parameter, and their effects are multiplied together. This means that if either of them is at zero, there will be no modulation. However, there is no reason why you can’t have further slots routing these or other sources to the same parameter. In this case, the control signals from different slots “add” to produce the overall effect.

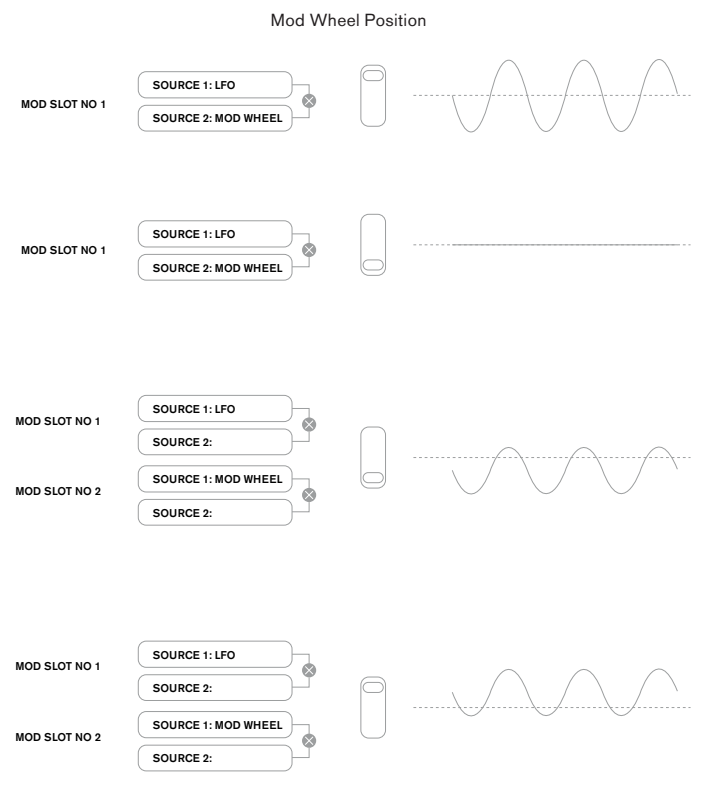



You need to be careful when setting up matrix assignments like this to ensure that the combined effect of all the controllers acting simultaneously still creates the sound that you want.

In addition, the Modulation Menu lets you assign the two **ANIMATE** buttons as sources (see page 12).

Slot number

Displayed as: Slot
Initial value: 1
Range of adjustment: 1 to 16

Slot lets you select one of 16 'slots', each defining a routing assignment of one (or two) sources to a destination. All the slots have the same selection of sources and destinations and any or all can be used. The same source can control multiple destinations, and one destination can be controlled by multiple sources.

Destination

Displayed as: Destination
Initial value: O123Ptch
Range of adjustment: See table at page 38 for full details

This sets the parameter to be controlled by the selected source (or sources) in the currently selected slot. The range of possibilities includes:

parameters that directly affect the sound:

- three parameters per oscillator (Pitch, Vsync and Shape)
- global pitch (O123Ptch)
- the five mixer inputs from the oscillators, noise source, ring modulator and the mixer output (see Tip below)
- Filter frequency, resonance and distortion

parameters that can also act as modulating sources (thus permitting recursive modulation):

- LFO 1 & 2 frequency
- the Attack, Decay and Release phases of all three Envelopes
- Frequency Modulation of oscillators (FM) by filter other oscillators or Noise



The mixer output (VCA level) is an unusual matrix destination! The VCA is the main output stage for the synth and this is normally under the sole control of the Amplitude Envelope, but Peak lets you assign the VCA as a destination in the Mod Matrix. If either Source A or Source B is not set to an Envelope, the VCA can be controlled independently of any notes being played.

Depth

Displayed as: Depth
Initial value: 0
Range of adjustment: -64 to +63

The **Depth** parameter sets "how much" control is being applied to the Destination – i.e., the parameter being modulated by the selected source(s). If both Source 1 and Source 2 are active in the slot in question, **Depth** controls their combined effect



Depth effectively defines the "amount" by which the controlled parameter varies when under modulation control. Think of it as the "range" of control. It also determines the "sense" or polarity of the control – positive values of **Depth** will increase the value of the controlled parameter and negative values will decrease it, for the same control input. Note that having defined Source and Destination in a patch, no modulation will occur until the **Depth** control is set to something other than zero.

Negative values of **Depth** do not work on certain parameters, unless modulation is already being applied to that parameter by some other routing, in which case the negative sense "cancels" the modulation already present. Examples are: i) Oscillator Vsync – needs to be applied via the Oscillator Menu before it can be reduced by a Mod Matrix routing; ii) FM of one oscillator by another – another mod slot must already be applying the FM before it can be cancelled.



With both sources set to Direct, the parameter control becomes a "manual" modulation control which will always affect whichever parameter is set as the Destination.

Note that **Depth** is available as a parameter on both pages of the Mod Menu.

Sources

Displayed as:	SourceA	and	SourceB
Initial values:	Direct		Direct
Range of adjustment:	See table at page 37 for full details		

Each of these selects a control source (modulator), which will be routed to the synth element selected by **Dest.in**. Setting both **SourceA** and **SourceB** to Direct means that when the **Depth** for the Slot is set to a non-zero value, a constant change to the **Destination** parameter will result (there is no modulator to change this over time).

Note that the list of sources allows for Expression pedals. If you connect an Expression pedal to either the rear panel pedal connectors, or to corresponding connectors on a controlling keyboard, they can be selected to control any **Destination** you wish in the normal way. If you wish an Expression pedal to control overall synth volume in a natural way, choose **VcaLevel** as the routing destination for Slot A and **AMPENV** for Slot B.

The CV input is also available as a source for the Mod Matrix. The CV input can be routed to any of the available mod destinations. The CV input has been designed to respond to control inputs without aliasing up to just over 1 kHz (which roughly corresponds to two octaves above middle C).



The Modulation Matrix **AftTouch** source will accept either channel aftertouch, which is the most common type of aftertouch, or can be used with polyphonic aftertouch, as generated by some controllers such as the Novation LaunchPad Pro. When polyphonic aftertouch is received, the pressure applied during a note event is interpreted as a modulation event for this one note only. This provides a level of expressivity in playing that is uncommon with hardware synths.

Glide

Peak's Glide function makes notes played sequentially glide from one to the next, rather than immediately jumping from one pitch to another. It is enabled with the **Glide On** button [29]. The synth remembers the last note played per Voice (see below) and the glide – up or down – will start from that Voice's last triggered's pitch even after the key has been released. The duration of the glide is set by the Time control [28]: a value of 90 equates to approximately 1 second.

Glide is primarily intended for use in a mono Mode, where it is particularly effective. It can also be used in Poly modes, but its operation can be slightly unpredictable, because the glide will be from the previous note used by the voice now assigned to the note being played. This may be particularly evident with chords. Note that **PreGlide** must be set to zero in order for Glide to be operative.

See also the **PreGlide** parameter in the Voices menu (page 28).

Voices

Peak is a multi-voice, polyphonic synthesiser, which basically means you can play chords on the keyboard, and every note you hold down will sound. As you play, each note is assigned one or more 'voices', and as **Peak** supports eight voices, you will often run out of fingers before you run out of voices! But this does depend on how many voices are assigned to each note – see the **Unison** parameter in the Voice Menu on page 28). However, if you are controlling **Peak** from a MIDI sequencer or DAW, it is possible to run out: sequencers don't have the human constraint of a finite number of fingers. Although this is likely to happen infrequently, users may occasionally observe this phenomenon, which is termed 'voice stealing'.

The alternative to polyphonic voicing is mono. With mono voicing, only one note sounds at a time; pressing a second key while holding the first down will cancel the first and play the second – and so on. The last note played is always the only one that you hear. All the early synths were mono, and if you are trying to emulate a 1970s analogue synth, you may wish to set the voicing to mono as the mode imposes a certain restriction on playing style that will add to authenticity.

Press the **Voice** button [56] to open the Voice Menu, which comprises three pages. In addition to selecting polyphonic or mono voicing, the menu also lets you set how Glide operates and other related voicing parameters.

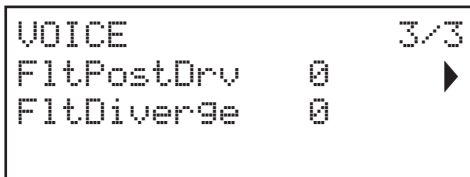
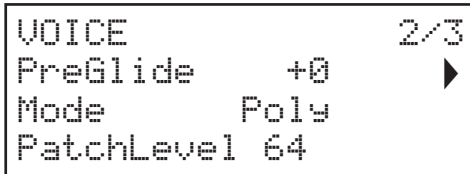
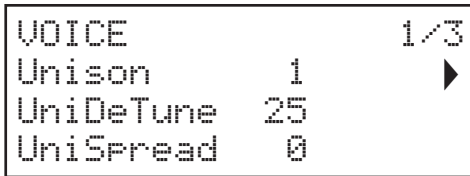

Unison

Displayed as: Unison
 Initial value: 1
 Range of adjustment: 1, 2, 3, 4, 8

Unison can be used to "thicken" the sound by assigning additional voices (up to eight in total) for each note. Be aware that the "reservoir" of voices is finite and with multiple voices assigned, Peak's polyphonic capability may be reduced. With four voices per note, only two notes may be played together fully polyphonically, and if further notes are played, "voice stealing" is implemented and the first note played will be cancelled. With Unison set to 8, Peak becomes a multi-voice monophonic synth.



If the limitation on polyphony imposed by Unison Voices is restrictive and the oscillators are set to Sawtooth, a similar effect can be obtained by using the SawDense and DenseDet parameters in the Oscillator Menu. (In fact, some of the factory patches use this technique.) SawDense and DenseDet have no impact on the polyphony.

Voice DeTune

Displayed as: UniDeTune
 Initial value: 25
 Range of adjustment: 0 to 127

Unison Detune is only effective when Unison is set to something other than 1. The parameter determines how much each voice is detuned relative to the others; detuning is generally desirable as adding additional "identical" voices has much less effect.

Voice panning

Displayed as: UniSPrEad
 Initial value: 0
 Range of adjustment: 0 to 127

UniSPrEad gives you a method of controlling how the separate voices are positioned in the stereo image. With UniSPrEad set to zero, all voices are centrally panned, effectively providing a mono image. As the value of UniSPrEad is increased, multiple voices are panned increasingly left and right – odd-numbered voices to the left and even to the right.

Stereo image placement diagram for 4 voice unison with UniSPrEad set mid way

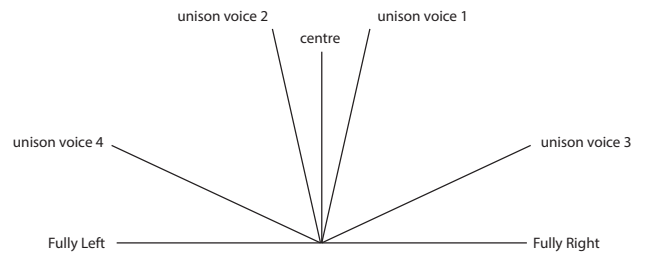

Stereo image placement diagram for 4 voice unison with UniSPrEad increased

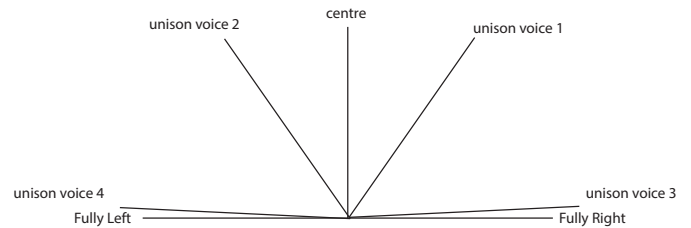

Note that UniSPrEad is still effective even with unison voices set to zero: in this case, a single note played is positioned centrally in the stereo image, while playing multiple notes results in left or right panning, depending whether the voice in use is odd- or even-numbered. When used like this, best results are obtained with moderate amounts of UniSPrEad.

Pre-Glide

Displayed as: PreGlide
 Initial value: Off
 Range of adjustment: Off, -12 to +12

If set to a value other than zero, Pre-Glide takes priority over Glide, though it does use the setting of Glide's Time control [28] to determine its duration. Note that Glide must also be On [29] for Pre-Glide to work. PreGlide is calibrated in semitones, and each note played will actually begin on a chromatically-related note up to an octave above (value = +12) or below (value = -12) the note corresponding to the key pressed, and glide towards the 'target' note. This differs from Glide in that, e.g., two notes played in sequence will each have their own Pre-Glide, related to the notes played, and there will be no glide 'between' the notes.



Although the use of Glide is not recommended in Poly modes when playing more than one note at a time, this restriction does not apply to Pre-Glide, which can be very effective with full chords.

Polyphony Mode

Displayed as:	Mode
Initial value:	Poly
Range of adjustment:	Mono, MonoLG, Mono2, Poly, Poly2

As the names imply, three of the possible modes are mono and two are polyphonic.

- Mono** – this is standard monophonic mode; only one note sounds at a time, and the “last played” rule applies - if you play more than key, only the last pressed will be heard. The same voice or voices are used for every note: this means each note played will re-trigger the voices even if the previous note is still sounding. When selected On, Glide will always be operative between successive notes.
- MonoLG** – LG stands for Legato Glide. This is an alternative mono mode, which differs from Mono in the way Glide and Pre-Glide work. In MonoLG mode, Glide and Pre-Glide only work if the keys are played in a legato style; playing notes separately produces no glide effect. As with Mono, the same voices are re-used for every note.
- Mono 2** – this mode operates in the same way as Mono, except that voices are assigned “in rotation” as each note is played. Unlike Mono or MonoLG, this has the effect (depending on playing speed) of allowing each note to complete its individual envelope. The main advantage of the Mono 2 voice mode is when using envelopes with an amount of attack as the envelope is always reset. This is not how analogue envelope generators work, but many digital envelope generators work on this principle.
- Poly** – in polyphonic mode, up to eight voices can sound simultaneously: depending on how many voices are assigned in the Patch, this means that you can play up to eight notes simultaneously. If you play the same note repeatedly, each note will be assigned a different voice, and you will hear the individual envelopes of every note.
- Poly 2** – in this alternative polyphonic mode, successively playing the same note(s) uses the same voices, the voices being re-triggered by new notes. This can change the behaviour of voice stealing. For example, in Poly mode, when playing chord shapes with similar notes (e.g., Amin7 to Cmaj) the notes C, E and G will be played twice as well as the A and the B, i.e., a total of eight voices. If playing a melody in the other hand, one voice from the first chord will be stolen, which may be the lowest A. If Mode is set to Poly 2, the C, E and G will only be played once, which will leave three voices free for playing a melody.

The effect of the different polyphony modes can be quite subtle, depending on the Patch in use and playing style, and we recommend that you experiment!

Patch Level

Displayed as:	Patch Level
Initial value:	64
Range of adjustment:	0 to 127

This is an additional level trim control, whose setting is saved with the Patch. This allows you to set the overall volume of each Patch, so that all the Patches in use are at the levels that you want. With a value of 0, the Patch volume is halved; with a value of 127, it is doubled.

Filter Post Drive

Displayed as:	FltPostDrv
Initial value:	0
Range of adjustment:	0 to 127

This parameter controls how much pre-envelope distortion is added to the sound after the filter, but (crucially) before the amplifier. This distortion will thus remain constant when the amplifier is gradually opened and closed by the amplitude envelope, unlike that added by the Effects section **DISTORTION Level** control [43], which follows the amplifier in the signal chain.

Filter Divergence

Displayed as:	FltDiverge
Initial value:	0
Range of adjustment:	0 to 127

This parameter re-creates the subtle effect of poor filter calibration found on early analogue synths. The filter for each voice is deliberately detuned by a different, fixed amount. The effect will be more apparent when the filter is close to resonance.

The Arpeggiator

Peak has a versatile Arpeggiator (Arp) feature which allows arpeggios of varying complexity and rhythm to be played and manipulated in real-time. When the Arpeggiator is enabled and a single key is pressed, its note will be retriggered. If you play a chord, the Arpeggiator identifies its notes and plays them individually in sequence (this is termed an arpeggio pattern or 'arp sequence'); thus if you play a C major triad, the selected notes will be C, E and G.

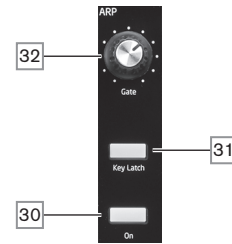

There are only three panel controls for the Arpeggiator: most of the arp parameters – including tempo, pattern, octave range and type (up/down) - are set up in the Arp menu (see below). The Arpeggiator is enabled by pressing the **On** button [30].

The **Key Latch** button [31] plays the currently selected arp sequence repeatedly without the keys being held. If further key(s) are pressed while the initial keys are being held down, the extra note(s) will be added to the sequence. If further keys are pressed after releasing all the notes, a new sequence consisting only of the new notes will be played.

The **Gate** control [32] sets the basic duration of the notes played by the Arpeggiator (though this will be further amended by both the **Rhythm** and **SyncRate** menu settings). Gate length is a percentage of the step length so the time during which the gate is open depends on the master clock speed. The lower the parameter value, the shorter the duration of the note played. At its maximum value (127), one note in the sequence is immediately followed by the next without a gap. At the default value of 64, the note duration is exactly half the beat interval (as set by the **ClockRate** parameter in the menu), and each note is followed by a rest of equal length.

Arp data transmission

Peak will both transmit MIDI note data from the arpeggiator, and allow the arpeggiator to play notes according to received MIDI note data. See “Arp MIDI mode” on page 34 for more information.

The Arp/Clock Menu

The following additional Arpeggiator parameters are available in the Arp/Clock menu, which has three pages:

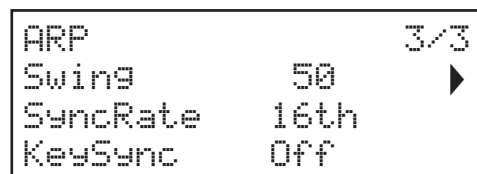
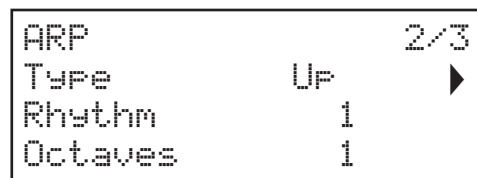
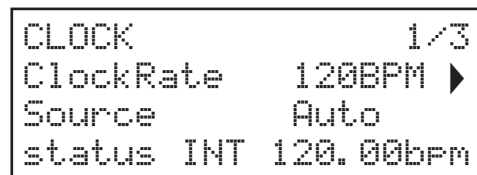

Tempo

Displayed as: `ClockRate`
 Initial value: 120 BPM
 Range of adjustment: 40 to 240 BPM

`ClockRate` sets the basic tempo of the arp sequence and you can make it play faster or slower by adjusting it. The range is 40 to 240 BPM. If Peak is being synchronised to an external MIDI clock, it will automatically detect the incoming tempo and disable the internal clock. The tempo of the arp sequence will then be determined by the external MIDI clock.



If the external MIDI clock source is removed, the Arpeggiator will continue to "flywheel" at the last known tempo. However, if you now adjust `ClockRate`, the internal clock will take over and override the flywheel rate.

Clock source

Displayed as: `Source`
 Initial value: Auto
 Range of adjustment: Auto, Internal, Ext-Auto, MIDI, USB

Peak uses a master MIDI clock in order to set the tempo of the arpeggiator and to provide a time base for synchronisation to an overall tempo. This clock may be derived internally or provided by an external device able to transmit MIDI clock. The `Source` setting determines whether Peak's tempo-synchronised features (Arpeggiator, Delay Sync and LFO Rate Sync) will follow the tempo of an external MIDI clock source or follow the tempo set by the `ClockRate` parameter. The options are:

- Auto – when no external MIDI clock source is present Peak will default to the internal MIDI clock. Tempo will be set by the `ClockRate` parameter. If an external MIDI clock is present, Peak will synchronise to it.
- Internal – Peak will synchronise to the internal MIDI clock irrespective of what external MIDI clock sources may be present.
- Ext-Auto – this is an auto-detect mode whereby Peak will synchronise to any external MIDI clock source (via USB or MIDI connection). Until external clock is detected, Peak will run at its internal clock rate. When external clock is detected, Peak synchronises to it. If external clock is subsequently lost (or stopped), Peak's tempo then "flywheels" to the last-known clock rate.
- MIDI – synchronisation will be to an external MIDI clock connected to the (DIN) MIDI input socket. If no clock is detected, the tempo "flywheels" to the last-known clock rate.
- USB – synchronisation will be to an external MIDI clock received via the USB connection. If no clock is detected, the tempo "flywheels" to the last-known clock rate.

When set to either of the external MIDI clock sources the tempo will be at the MIDI Clock rate received from the external source (e.g., a sequencer). Make sure the external sequencer is set to transmit MIDI Clock. If unsure of the procedure, consult the sequencer manual for details.

Most sequencers do not transmit MIDI Clock while they are stopped. Synchronisation of Peak to MIDI Clock will only be possible while the sequencer is actually recording or playing. In the absence of an external clock, the tempo may flywheel and will assume the last known incoming MIDI Clock value. In this situation, the 4th row of the OLED will display `FLY`. (Note that Peak does NOT revert to the tempo set by the `ClockRate` parameter unless Auto is selected.)

Arp Mode

Displayed as: `Type`
 Initial value: Up
 Range of adjustment: See table below

When enabled, the Arpeggiator will play all notes held down in a sequence which is determined by the `Type` parameter. The third column of the table describes the nature of the sequence in each case.

ARP MODE	DESCRIPTION	COMMENTS
Up	Ascending	Sequence begins with lowest note played
Down	Descending	Sequence begins with highest note played
Up-Down 1	Ascend/descend	Sequence alternates
Up Down 2		As Up-Down 1, but lowest and highest notes are played twice
Played	Key order	Sequence comprises notes in the order in which they are played
Random	Random	The notes held are played in a continuously-varying random sequence
Chord	Chord	The notes making up the sequence are played simultaneously, as a chord

Arp Rhythm

Displayed as: `Rhythm`
 Initial value: 1
 Range of adjustment: 1 to 33

As well as being able to set the basic timing and mode of the arp sequence (with the `ArpMode` and `SyncRate` parameters), you can also introduce further rhythmic variations with the `Rhythm` parameter. The Arpeggiator comes with 33 pre-defined arp sequences; use the `Rhythm` parameter to select one. In very general terms, the sequences increase in rhythmic complexity as the numbers increase; Rhythm 1 is just a series of consecutive crotchets, and higher-numbered rhythms introduce more complex patterns, shorter duration notes (semiquavers) and syncopation.



You should spend some time experimenting with different combinations of `Rhythm` and `Type`. Some patterns work better with certain choices of `Type`.

Octave range

Displayed as: `Octaves`
 Initial value: 1
 Range of adjustment: 1 to 6

The `Octaves` parameter allows upper octaves to be added to the arp sequence. When set to 2, the sequence is played as normal, then immediately played again an octave higher. Higher values extend this process by adding additional higher octaves. Settings other than 1 have the effect of doubling, tripling, etc., the length of the sequence. The additional notes added duplicate the complete original sequence, but octave-shifted. Thus a four-note sequence played with `Octaves` set to 1 will consist of eight notes when `Octaves` is set to 2.

Swing

Displayed as: `Swing`
 Initial value: 50
 Range of adjustment: 20 to 80

If `Swing` is set to something other than its default value of 50, some further interesting rhythmic effects can be obtained. Higher values lengthen the interval between odd and even notes, while the even-to-odd intervals are correspondingly shortened. Lower values have the opposite effect. This is an effect which is easier to experiment with than describe!

Arp Rate Sync

Displayed as: `SyncRate`
 Initial value: 16th
 Range of adjustment: See table at page 36 for full details

This parameter effectively determines the beat of the arp sequence, based on the tempo rate set by the `ClockRate` parameter.

Arp Key Sync

Displayed as: `KeySync`
 Initial value: Off
 Range of adjustment: Off or On

`KeySync` only applies only when **Key Latch** [31] is On. It determines how the sequence behaves when a new set of notes is played. With `KeySync` off, the notes are changed but the constant rhythm dictated by the arp pattern is maintained. If `KeySync` is On, the arp pattern will be interrupted immediately the keys are struck.

The Effects Section

Peak comes equipped with a sound effects (FX) section. FX can be applied to the sound the synth is generating to add colour and character. All FX parameters are saved with the Patch.

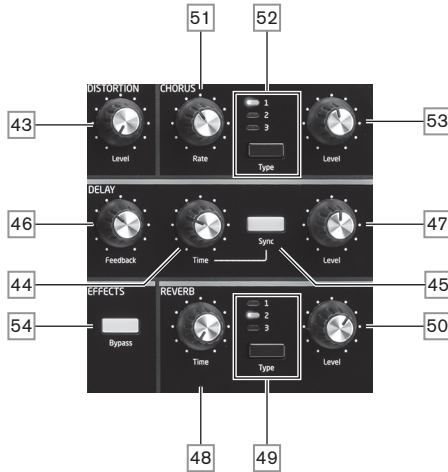

The FX tools comprise analogue distortion and three digital “time-domain” effects: Reverb, Chorus and Delay. Each has its own set of controls and any or all FX may be used without restriction.

In addition, the FX Menu provides extensive control of additional parameters for the digital FX. These may be used in parallel configuration, or arranged in series in any order: the configurations are set up in the FX Menu.

The FX processing section is active by default: the **Bypass** button [54] switches the digital FX processing out of circuit: it does not bypass the Distortion processor.

Distortion

Distortion may be added with the single **Level** control [43]. A controlled amount of distortion is added after the VCA, in the analogue domain, and affects the sum of the eight voices. This means that the distortion characteristic will change as the amplitude of the signal changes over time as a result of the Amplitude Envelope, and also with the number of active voices.

The output from the Distortion processor is then routed to the other FX.

Note that “per-voice” distortion may be added by adjusting **Post Filter Drive** in the Voice menu.

Chorus

Chorus is an effect produced by mixing a continuously delayed version of the signal with the original. The characteristic swirling effect is produced by the Chorus processor’s own LFO making very small changes in the delays. The changing delay also produces the effect of multiple voices, some of which are pitch-shifted; this adds to the effect.

Peak has three stereo Chorus programs (simply numbered **1, 2 and 3**), selected by the **Type** button [52]. Type 1 is a two-tap chorus, Type 2 uses four taps and Type 3 is an ensemble effect. The amount of Chorus effect added to the “dry” signal is adjusted by the **Level** control [53]. The **Rate** control [51] sets the frequency of the Chorus processor’s dedicated LFO. Lower values give a lower frequency, and hence a sound whose characteristic changes more gradually. A slow rate is generally more effective.

There are further Chorus parameters available for adjustment in the FX Menu

Delay

The Delay FX processor produces one or more repetitions of the note played. Although the two are intimately related in an acoustic sense, delay should not be confused with reverb in terms of an effect. Think of delay simply as “Echo”.

The **Time** control [44] sets the basic delay time: the note played will be repeated after a fixed time. Higher values correspond to a longer delay, with the maximum value of 127 equating to approx. 1.4 seconds. If **Time** is varied while a note is being played, pitch shifting will result.

It is often desirable to synchronise echoes to tempo: on Peak this can be done by selecting **Sync** [45]. The **Time** control then varies the **DelaySync** parameter, which is displayed on the OLED while the control is adjusted. The sync value is limited by the maximum delay time of 1.4 seconds, consequently some combinations of **ClockRate** and **DelaySync** result in truncating the delay time to the maximum calculated sync rate permissible, i.e., the delay time will reduce, but it will remain in sync.

The output of the delay processor is connected back to the input, at a reduced level; The **Feedback** control [46] sets the level. This results in multiple echoes, as the delayed signal is further repeated. With **Feedback** set to zero, no delayed signal at all is fed back, so only a single echo results. As you increase the value, you will hear more echoes for each note, though they still die away in volume. Setting the control in the centre of its range (64) results in about 5 or 6 audible echoes; at the maximum setting the decay in volume is almost imperceptible and the repetitions will still be audible after a minute or more.

The **Level** control [47] adjusts the level of the echoes: at the maximum setting (127), the first echo is approximately the same volume as the initial, dry note.

There are further Delay parameters available for adjustment in the FX Menu

Reverb

Reverberation (reverb) adds the effect of an acoustic space to a sound. Unlike delay, reverb is created by generating a dense set of delayed signals, typically with different phase relationships and equalisations applied to re-create what happens to sound in a real acoustic space.

Peak provides three reverb presets, selected by the **Type** button [49]. The presets are simply numbered 1, 2 and 3, and set the **RevsSize** parameter (see page 32) to values of 0, 64 or 127 respectively, thus simulating spaces of different sizes.

The **Time** control [48] sets the basic reverb time of the selected space and sets the time that the reverb takes to die away to inaudibility. The **Level** control [50] adjusts the volume of the reverb.

The FX Menu

The following additional parameters for the three time-domain effects are available in the **FX** menu. Two menu pages each are dedicated to Chorus and Delay and three to Reverb. There is also one further page (Page 1/8), with “global” parameters affecting all three effects.

Chorus pages:

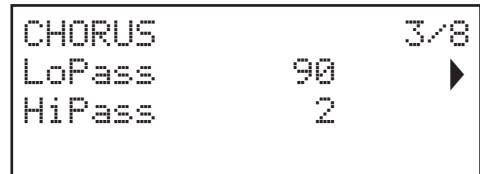
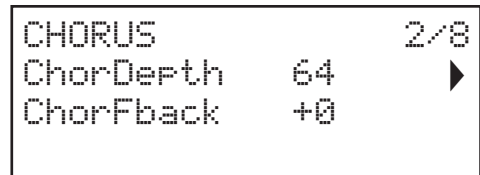

Chorus Depth

Displayed as:	ChorDepth
Initial value:	64
Range of adjustment:	0 to 127

The **ChorDepth** parameter determines the amount of LFO modulation applied to the Chorus delay time, and thus the overall depth of the effect. A value of zero results in no chorus effect being added.

Chorus Feedback

Displayed as:	ChorFback
Initial value:	0
Range of adjustment:	-64 to +63

The Chorus processor has its own feedback path between output and input, and a degree of feedback can be applied to get a more effective sound. Negative values of the **ChorFback** parameter mean that the signal being fed back is phase-reversed: High values – positive or negative – can add a dramatic “swooping” effect. Adding feedback and keeping the value of **ChorDepth** low will turn the Chorus FX into a flanger.

Chorus EQ

Displayed as:	LoPass		HiPass
Initial values:	90	and	2
Range of adjustment:	0 to 127		0 to 127

The `LoPass` and `HiPass` parameters adjust simple HF and LF filters within the Chorus processor. Adjusting these will enhance or mask some of the additional harmonics added to the sound by the Chorus effect.

Delay pages:

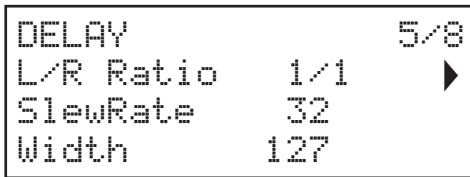
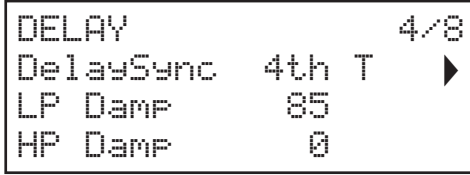

Delay Sync

Displayed as:	DelaySync
Initial value:	4th T
Range of adjustment:	See table at page 36 for full details

Delay time may be synchronised to the internal or external MIDI clock, using a wide variety of tempo dividers/multipliers to produce delays from about 5 ms to 1 second.

The value of `DelaySync` is also displayed while the front panel **Time** control [44] is being adjusted, when **Sync** [45] is set On.

Be aware that the total delay time available is finite. Using large tempo divisions at a very slow tempo rate may exceed the delay time limit.

Damping

Displayed as:	LP Damp		HP Damp
Initial values:	85	and	0
Range of adjustment:	0 to 127		0 to 127

Echoes produced acoustically by reflections in physical spaces decay at different rates at different frequencies, depending on the type of surface producing the reflection. The two Damping parameters allow a simulation of this effect. Note that the varying decay only applies to the delayed notes, not to the initial one. See also the Damping parameters in the Reverb processor.

Left-Right Ratio

Displayed as:	LR Ratio
Initial value:	1/1
Range of adjustment:	1/1, 4/3, 3/4, 3/2, 2/3, 2/1, 1/2, 3/1, 1/3, 4/1, 1/4

The value of this parameter is a ratio, and determines how each delayed note is distributed between the left and right outputs. Setting `LR Ratio` to the default 1/1 value places all echoes centrally in the stereo image. With other values, echoes are alternated between left and right at simple ratios of the delay time.

Delay Slew Rate

Displayed as:	SlewRate
Initial value:	32
Range of adjustment:	0 to 127

The value of `SlewRate` affects the nature of the sound while the Delay Time is being varied. Varying delay time produces pitch-shifting. With `Slew Rate` set to the maximum value (127), almost no pitch-shift effects will be heard as the **Time** control [44] is adjusted. With lower values, the pitch-shift effects become more evident. As the purpose of varying delay time in performance is generally to produce pitch shift artefacts, a medium value is usually desirable.

Width

Displayed as:	Width
Initial value:	127
Range of adjustment:	0 to 127

The `Width` parameter is only really relevant to settings of `LR Ratio` which result in the echoes being split across the stereo image. With its default value of 127, any stereo placement of delayed signals will be fully left and fully right. Decreasing the value of `Width` reduces the width of the stereo image and panned echoes tend towards the centre position.

Reverb pages:

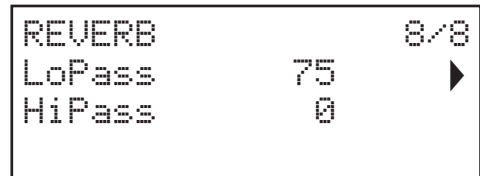
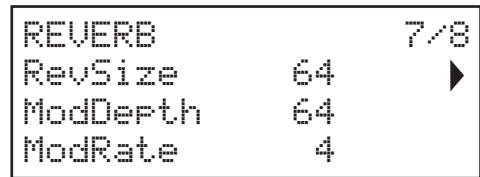
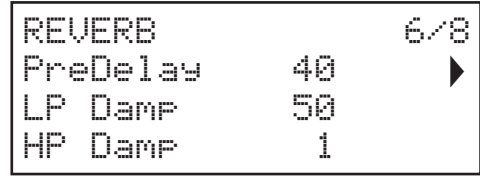

PreDelay

Displayed as:	PreDelay
Initial value:	40
Range of adjustment:	1 to 127

In a very large space, the first reflections making up the reverberation are not heard immediately. `PreDelay` controls how soon after the start of the initial note the reverberation begins, and thus allows a more accurate simulation of a real space to be created. With `PreDelay` set to its maximum value (127), the first reflections are delayed by approximately half a second.

Damping

Displayed as:	LP Damp		HP Damp
Initial values:	50	and	1
Range of adjustment:	0 to 127		0 to 127

These two parameters perform the same function for the reverb processor as the corresponding ones in the Delay processor, in that they simulate the effect of frequency-dependent absorption coefficients of different surfaces.

Size

Displayed as:	RevSize
Initial value:	64
Range of adjustment:	1 to 127

The `RevSize` parameter alters the reverberation character: larger values introduce additional and more prominent reflections, simulating the effect of a larger physical space. Note that the **Type** button [49] sets `RevSize` to 0, 64 or 127, so the menu option allows finer adjustment between these values.

Reverb Modulation

Displayed as:	ModDepth		ModRate
Initial values:	64	and	4
Range of adjustment:	0 to 127		0 to 127

The reverb processor includes a dedicated modulation source, which can be used to continuously vary the reverb time (set with the **Time** control [48]). Two parameters are provided: `ModDepth`, which controls the degree of modulation and `ModRate`, which controls the modulation rate.

Reverb EQ

Displayed as:	LoPass		HiPass
Initial values:	74	and	0
Range of adjustment:	0 to 127		0 to 127

These two parameters basically constitute a simple LF/HF EQ section for the reverb envelope itself. The effects differ from those of the Damping parameters: LoPass and HiPass are simple filters for the overall reverberation (not the initial note) while LP Damp and HP Damp are coefficients defining how the reverb algorithm itself operates.

Global FX page:

The default menu display is shown below:

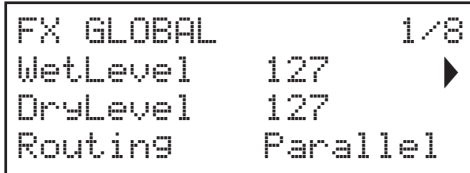

The parameters available on the Global FX page affect all three time-domain FX processors (Chorus, Delay and Reverb).

Wet and Dry Levels

Displayed as:	WetLevel		DryLevel
Initial values:	127	and	127
Range of adjustment:	0 to 127		0 to 127

The terms "wet" and "dry" as applied to FX processors respectively refer to the untreated signal, i.e., the input to the processors, and the treated signal, i.e., the output of the processors. It is normal to mix these together and the default parameter values (both 127) create a full-level, equal mix. By reducing DryLevel, the treated signal will predominate, which can produce some unusual and interesting effects with reverb and delay. With WetLevel at zero, no processing effect will be audible.

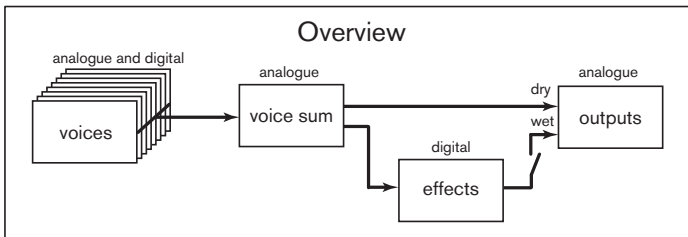

FX Routing

Displayed as:	Routing
Initial value:	Parallel
Range of adjustment:	Parallel, D->R->C, D->C->R, R->D->C, R->C->D, C->D->R, C->R->D

When using more than one of the three time-domain effects (Chorus, Delay and Reverb) simultaneously, the overall effect will differ depending on the order of processing. For example, if Delay precedes Reverb, each echo added to notes by the Delay processor will initiate its own reverb envelope. If Delay follows Reverb, the Delay processor will attempt to generate a multiplicity of fresh reverb envelopes as repeats. Routing allows you to arrange the three time-domain processors in series in any order, or to configure them to process sounds in parallel, i.e., simultaneously, with the outputs being blended together. In parallel (the default configuration), the overall result is subtly different from any of the series configurations.

The Settings Menu

Press the Settings button [56] opens the Settings Menu (eight pages). This menu contains a set of synth and system functions which, once set up, will not generally need to be accessed on a regular basis. The Settings Menu includes Patch backup routines, MIDI and pedal settings among other functions.

Note that the Settings Menu defines settings which are global for the synth, and are not saved with individual Patches. However, it is possible to retain the current contents of the Settings menu by opening the menu and pressing Save [4]. This will ensure that the settings (such as WaveShape and Patch Memory Protection) are reinstated after power-cycling. Note that saving Settings in this way will also save the current Patch as a default, and this Patch will be re-loaded at the next power-up.

System pages:

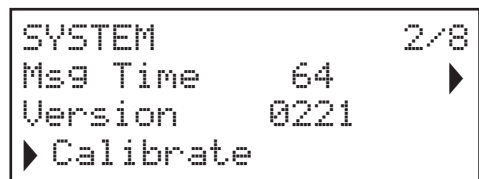
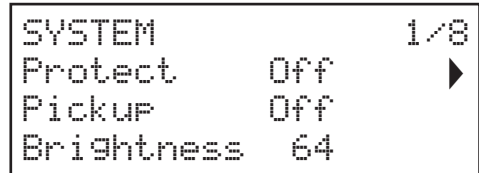

Patch Memory Protection

Displayed as:	Protect
Initial value:	Off
Range of adjustment:	On or Off

Setting Protect to On disables Peak's Patch Save function: pressing Save will generate the display message below:

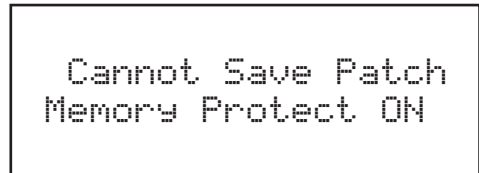

This is a useful function if you need to be sure that Patches already saved (including factory Patches) cannot be overwritten.

Pickup

Displayed as:	Pickup
Initial value:	Off
Range of adjustment:	On or Off

The setting of Pickup allows the current physical position of Peak's rotary controls to be taken into account. When Pickup is Off, adjusting any of Peak's rotary controls will produce parameter change and an immediately audible effect. When set to On, the control needs to be moved to the physical position corresponding to the value of the parameter saved for the currently loaded Patch, and will only alter the parameter value once that position is reached. For parameters with a range of 0 to 255, this means the 12 o'clock position will correspond to a value of 127; for parameters with a range of -64 to +63, the 12 o'clock position will correspond to a value of zero.

Brightness

Displayed as:	Brightness
Initial value:	64
Range of adjustment:	0 to 127

Adjusts the brightness of the OLED display.

Message Time

Displayed as: Msg Time
 Initial value: 64
 Range of adjustment: 0 to 127

MSG TIME sets the time for which parameter values (and the saved value for the current Patch) are displayed when a rotary control is adjusted. The maximum time (value = 127) is equivalent to approx. 3 seconds.

OS version

Displayed as: Version

This is read-only data, and reports Peak's OS (Operating System) version. This lets you ensure that you have the most up-to-date OS installed.

Auto Calibration

Displayed as: Calibrate

Pressing the Row 3 button initiates a calibration routine which sets up the filters, VCAs and distortion circuitry accurately. This will have been done at the factory and should not need to be run again, but the routine has been included for good measure. The procedure takes several minutes, and the synth should not be touched while in progress. Note that the routine overrides the master volume control and sets it to maximum.

WARNING: The test generates various tones which will be present at the synth's outputs; we recommend you mute or turn off any external amplifier or loudspeakers connected as these tones will be at full volume.

When the calibration routine is complete, the display shows:

```
Calibration Complete
Re-Power Now
```

Synth page:

```
SYNTH 3/8
VelShape 64
TuneCents +0
Transpose +0
```

Key Response

Displayed as: VelShape
 Initial value: 64
 Range of adjustment: 0 to 127

This parameter modifies the synth's response to the velocity curve set on the controlling keyboard. The default value of 64 results in a linear relationship between the velocity curve and the synth's response. Reducing the value will result in lighter key touches producing a greater volume; a higher value results in the opposite. You can set the VelShape parameter to suit your normal playing style.

Master Fine Tuning

Displayed as: TuneCents
 Default value: 0
 Range of adjustment: -50 to +50

This control adjusts the frequencies of all the Oscillators by the same small amount, allowing you to fine-tune the whole synth to another instrument if necessary. The increments are cents (1/100 of a semitone), and thus setting the value to ± 50 tunes the synth to a quarter-tone midway between two semitones. A setting of zero tunes keyboard with the A above middle C at 440 Hz – i.e., standard Concert Pitch.

Transpose

Displayed as: Transpose
 Default value: +0
 Range of adjustment: -12 to +12

TRANSPOSE is a very useful global setting which "shifts" the received MIDI Note data up or down one semitone at a time. It differs from oscillator tuning in that it modifies the control data from a controlling keyboard rather than the actual oscillators. Thus setting TRANSPOSE to +4 means that you can play with other instruments in the actual key of E major, but only need to play white notes, as if you were playing in C major.

Note that TRANSPOSE does not affect Note data generated by the arpeggiator.

MIDI pages:

```
MIDI CONTROL 4/8
MidiChan 1
Local On
Arp>Midi On
```

```
MIDI ENABLE 5/8
CC/NRPN Rec+Tran
Bank/Patch Rec+Tran
```

Assign MIDI Channel

Displayed as: MidiChan
 Default value: 1
 Range of adjustment: 1 to 16

MIDI protocol provides for 16 channels of data. This allows up to 16 devices to co-exist on a MIDI network, provided each is assigned to operate on a different MIDI channel. MidiChan lets you set Peak to receive and transmit MIDI data on a particular channel, so that it can interface correctly with external equipment.

Local Control On/Off

Displayed as: Local
 Default value: On
 Range of adjustment: Off or On

In normal operation (with Local set to On), all of Peak's physical controls are active, and also transmit their settings as MIDI data, provided that CC/NRPN on Menu Page 5 is set to either Transmit or Rec+Tran (see below). With Local set to Off, the controls no longer vary any parameters in Peak's synth engine, but still transmit their settings as MIDI data in the same way.

Arp MIDI mode

Displayed as: Arp>Midi
 Default value: On
 Range of adjustment: Off or On

This setting determines how the arpeggiator handles MIDI data.

- Off: the arp responds to incoming MIDI note data, either via the MIDI IN DIN port or the USB port. Control data is transmitted from both the MIDI OUT and USB ports. If the note data is supplied via the MIDI IN port, it is also retransmitted from MIDI THRU.
- On: In this setting, the arp responds to received MIDI note data in the same manner, but additionally transmits arpeggiator note data via both the MIDI OUT and USB ports, along with control data.

MIDI control data

Displayed as: CC/NRPN
 Default value: Rec+Tran
 Range of adjustment: Disabled, Receive, Transmit, Rec+Tran

With the default CC/NRPN setting of Rec+Trans, Peak's physical controls transmit their settings as MIDI CC or NRPN data. The synth engine itself also responds to received MIDI CC/NRPN data with this setting. You can choose to only transmit MIDI data and not receive it (Transmit), or to receive it but not transmit (Receive). The fourth option, Disabled, effectively isolates Peak from any other MIDI equipment to which it is connected. See also Local Control On/Off above. Note that CC/NRPN messages do not include Patch data, which is handled separately as Program Change messages – see Bank/Patch.

Patch Select

Displayed as: Bank/Patch
Default value: Rec+Tran
Range of adjustment: Disabled, Receive, Transmit, Rec+Tran

This setting controls how Peak handles MIDI Program Change and Bank Change messages. The default value of Rec+Tran allows Peak to send a Program/Bank Change message whenever a new Patch is loaded, and also lets you load a Patch from an external MIDI controller, such as Novation Impulse. As with MIDI control data (above), you can choose to set Receive or Disabled, so that Peak does not transmit Program/Bank Change messages when you change Patches, or to set Transmit or Disabled, so that Peak does not respond to Program/Bank Change messages from external equipment.

Pedal pages:

```
PEDAL SW SENSE 6/8
Ped1Sense Auto
Ped2Sense Auto
```

```
PEDAL SW MODE 7/8
Ped1Mode Sustain
Ped2Mode Sostnuto
```

These two menu pages are concerned only with pedals of the switch (on/off) type. [If you are using one or more Expression pedals, these may be connected to either or both the two **PEDAL** sockets on the rear of the unit. There are no Settings Menu options for Expression pedals: they are assigned in the Mod Matrix on a per-Patch basis.]

Pedal Types

Displayed as: Ped1Sense Ped2Sense
Initial values: Auto and Auto
Range of adjustment: Auto, N/Open, N/Closed Auto, N/Open, N/Closed

Peak supports two foot switch pedals of various types. A sustain pedal or footswitch can be connected to Peak via the **PEDAL 1** or **PEDAL 2** sockets (5). Ascertain whether your sustain pedal is of the normally-open or normally-closed type, and set the `Ped1Sense` or `Ped2Sense` parameter to suit. If you are unsure which it is, connect the footswitch with Peak unpowered, and then power it on (without your foot on the pedal!) Provided the default value of Auto is still set, the polarity will be correctly sensed.

Pedal Modes

Displayed as: Ped1Mode Ped2Mode
Initial values: Animate1 and Animate2
Range of adjustment: Animate1, Sustain, Sostnuto Animate2, Sustain, Sostnuto

The Pedal Mode settings determine what you want the switch pedals to do. The default setup is for the two Pedals to act as foot switches for Peak's Animate functions: in this case, pressing a pedal triggers the Animate effect that has been defined within the Patch. You can alternatively assign either ped; to be a Sustain or a Sostenuto pedal (like the middle pedal on a three-pedal piano).

Backup Page:

Novation recommends the use of Novation Components online Librarian to fully manage your Patches – see page 36. However, you may also import and export Patch data via MIDI SysEx messages, using applications such as SysEx Librarian (Mac) or MIDI-OX (Windows).

```
BACKUP 8/8
Select Current
Send To USBport
Go
```

Select Patches

Displayed as: Select
Default value: Current
Range of adjustment: Current, Bank A, Bank B, Bank C, Bank D, A+B+C+D, Settings, ABCD+Set

`Select` lets you choose which Patches to back up as SysEx data. You can choose either the currently active Patch (`Current`), or any or all of the four Banks in full (128 Patches per Bank). You can also choose just to back up the current synth settings, with or without every Patch (`Settings` and `ABCD+Set` respectively).

Dump Port Select

Displayed as: Send To
Default value: USBport
Range of adjustment: USBport, MIDIout

You can choose to send the SysEx data via either the MIDI OUT socket or the USB port, with the `SendTo` setting. When you are ready to do the data dump, select the lower left-hand screen button, `Go`, to perform the action.

APPENDIX

System Updates using Novation Components

Novation Components is an online Patch Librarian, which allows you to manage your Patch library. You can also restore original factory Patches and download new ones as they become available.

Novation Components will also advise you if your Peak's Operating System is out of date and will update it for you if necessary.

Full details are available at www.novationmusic.com/register

Patch import via SysEx

It is also possible to import Patch data into Peak via MIDI SysEx messages using applications such as SysEx Librarian (Mac) or MIDI-OX (Windows). It is important to note that Patch Banks retain a reference to their original memory location and will be loaded back into that location on import. Thus any Patches already in those locations will be overwritten.

Sync values tables

Arp/Clock Sync Rate

This table lists the sync rate divisions available for the Arpeggiator clock SyncRate parameter (Arp/Clock menu, page 3).

Display	Display Meaning	Musical Description	MIDI Ticks*
8 beats	8 beats	1 cycle per 2 bars	192
6 beats	6 beats	1 cycle per 6 beats (2 cycles per 3 bars)	144
5 + 1/3	5 + 1/3	3 cycles per 4 bars	128
4 beats	4 beats	1 cycle per 1 bar	96
3 beats	3 beats	1 cycle per 3 beats (4 cycles per 3 bars)	72
2 + 2/3	2 + 2/3	3 cycles per 2 bars	64
2nd	2nd	2 cycles per 1 bar	48
4th D	4th dotted	2 cycles per 3 beats (8 cycles per 3 bars)	36
1 + 1/3	1 + 1/3	3 cycles per 1 bar	32
4th	4th	4 cycles per 1 bar	24
8th D	8th dotted	4 cycles per 3 beats (16 cycles per 3 bars)	18
4th T	4th triplet	6 cycles per 1 bar	16
8th	8th	8 cycles per 1 bar	12
16th D	16th dotted	8 cycles per 3 beats (32 cycles per 3 bars)	9
8th T	8th triplet	12 cycles per 1 bar	8
16th	16th	16 cycles per 1 bar	6

* Assuming a resolution of 24 PPQN

Delay Sync Rate

This table lists the sync rate divisions available for the DelaySyncRate parameter (FX Menu, page 4).

Display	Display Meaning	Musical Description	MIDI Ticks*
4 beats	4 beats	1 cycle per 1 bar	96
3 beats	3 beats	1 cycle per 3 beats (4 cycles per 3 bars)	72
2 + 2/3	2 + 2/3	3 cycles per 2 bars	64
2nd	2nd	2 cycles per 1 bar	48
4th D	4th dotted	2 cycles per 3 beats (8 cycles per 3 bars)	36
1 + 1/3	1 + 1/3	3 cycles per 1 bar	32
4th	4th	4 cycles per 1 bar	24
8th D	8th dotted	4 cycles per 3 beats (16 cycles per 3 bars)	18
4th T	4th triplet	6 cycles per 1 bar	16
8th	8th	8 cycles per 1 bar	12
16th D	16th dotted	8 cycles per 3 beats (32 cycles per 3 bars)	9
8th T	8th triplet	12 cycles per 1 bar	8
16th	16th	16 cycles per 1 bar	6
16th T	16th triplet	24 cycles per 1 bar	4
32nd	32nd	32 cycles per 1 bar	3
32nd T	32nd triplet	48 cycles per 1 bar	2

* Assuming a resolution of 24 PPQN

LFO Sync Rate

This table lists the sync rate divisions available for the LFO Sync clock; these are displayed when an LFO Rate control [18] is adjusted with Range [17] set to Sync.

Display	Display Meaning	Musical Description	MIDI Ticks*
64 beats	64 beats	1 cycle per 16 bars	1536
48 beats	48 beats	1 cycle per 12 bars	1152
42 beats	42 beats	2 cycles per 21 bars	1002
36 beats	36 beats	1 cycle per 9 bars	864
32 beats	32 beats	1 cycle per 8 bars	768
30 beats	30 beats	2 cycles per 15 bars	720
28 beats	28 beats	1 cycle per 7 bars	672
24 beats	24 beats	1 cycle per 6 bars	576
21 + 1/3	21 + 2/3	3 cycles per 16 bars	512
20 beats	20 beats	1 cycle per 5 bars	480
18 + 2/3	18 + 2/3	3 cycles per 14 bars	448
18 beats	18 beats	1 cycle per 18 beats (2 cycles per 9 bars)	432
16 beats	16 beats	1 cycle per 4 bars	384
13 + 1/3	13 + 1/3	3 cycles per 4 bars	320
12 beats	12 beats	1 cycle per 12 beats (1 cycle per 3 bars)	288
10 + 2/3	10 + 2/3	3 cycles per 8 bars	256
8 beats	8 beats	1 cycle per 2 bars	192
6 beats	6 beats	1 cycle per 6 beats (2 cycles per 3 bars)	144
5 + 1/3	5 + 1/3	3 cycles per 4 bars	128
4 beats	4 beats	1 cycle per 1 bar	96
3 beats	3 beats	1 cycle per 3 beats (4 cycles per 3 bars)	72
2 + 2/3	2 + 2/3	3 cycles per 2 bars	64
2nd	2nd	2 cycles per 1 bar	48
4th D	4th dotted	2 cycles per 3 beats (8 cycles per 3 bars)	36
1 + 1/3	1 + 1/3	3 cycles per 1 bar	32
4th	4th	4 cycles per 1 bar	24
8th D	8th dotted	4 cycles per 3 beats (16 cycles per 3 bars)	18
4th T	4th triplet	6 cycles per 1 bar	16
8th	8th	8 cycles per 1 bar	12
16th D	16th dotted	8 cycles per 3 beats (32 cycles per 3 bars)	9
8th T	8th triplet	12 cycles per 1 bar	8
16th	16th	16 cycles per 1 bar	6
16th T	16th triplet	24 cycles per 1 bar	4
32nd	32nd	32 cycles per 1 bar	3
32nd T	32nd triplet	48 cycles per 1 bar	2

Init Patch – parameter table

This list gives the values of all synth parameters in the Init Patch (the factory Patch initially loaded into Banks C and D). Parameters in italics are those accessed via the menu system.

Parameter	Initial Value
Oscillators	
Osc 1 fine	0 (centre)
Osc 1 range	8' (A3=440Hz)
Osc 1 coarse	0 (centre)
Osc 1 waveform	saw
Osc 1 Mod Env 2 depth	0 (centre)
Osc 1 LFO 2 depth	0 (centre)
Osc 1 Shape Amount	0 (centre)
Osc 1 Shape Source	Manual
<i>Osc 1 WaveMore</i>	<i>BS sine</i>
<i>Osc 1 FixedNote</i>	<i>Off</i>
<i>Osc 1 BendRange</i>	<i>+12</i>
<i>Osc 1 Vsync</i>	<i>0</i>
<i>Osc 1 SawDense</i>	<i>0</i>
<i>Osc 1 DenseDet</i>	<i>64</i>
Osc 2 fine	0 (centre)
Osc 2 range	8' (A3=440Hz)
Osc 2 coarse	0 (centre)
Osc 2 waveform	saw
Osc 2 Mod Env 2 depth	0 (centre)
Osc 2 LFO 2 depth	0 (centre)
Osc 2 Shape Amount	0 (centre)
Osc 2 Shape Source	Manual
<i>Osc 2 WaveMore</i>	<i>BS sine</i>
<i>Osc 2 FixedNote</i>	<i>Off</i>
<i>Osc 2 BendRange</i>	<i>+12</i>
<i>Osc 2 Vsync</i>	<i>0</i>
<i>Osc 2 SawDense</i>	<i>0</i>
<i>Osc 2 DenseDet</i>	<i>64</i>
Osc 3 fine	0 (centre)
Osc 3 range	8' (A3=440Hz)
Osc 3 coarse	0 (centre)
Osc 3 waveform	saw
Osc 3 Mod Env 2 depth	0 (centre)
Osc 3 LFO 2 depth	0 (centre)
Osc 3 Shape Amount	0 (centre)
Osc 3 Shape Source	Manual
<i>Osc 3 WaveMore</i>	<i>BS sine</i>
<i>Osc 3 FixedNote</i>	<i>Off</i>
<i>Osc 3 BendRange</i>	<i>+12</i>
<i>Osc 3 Vsync</i>	<i>0</i>
<i>Osc 3 SawDense</i>	<i>0</i>
<i>Osc 3 DenseDet</i>	<i>64</i>
Osc Common Diverge	0
Osc Common Drift	0
Osc Common Noise LPF	127
Mixer	
Osc 1 level	255
Osc 2 level	0
Osc 3 level	0
Noise level	0
Ring mod level	0
VCA gain	127

Parameter	Initial Value
Filter	
Slope	24dB
Shape	LP
Frequency	255
Resonance	0
Env depth	0
Env Source	Mod Env 1
LFO 1 depth	0
Osc 3 Filter Mod	0
Overdrive	0
Key Tracking	127
Glide	
Time	0
LFOs	
LFO 1 Type	Triangle
LFO 1 Range	High
LFO 1 Rate	128
LFO 1 Fade Time	50
<i>LFO 1 Fade Mode</i>	<i>FadeIn</i>
<i>LFO 1 Phase</i>	<i>Free</i>
<i>LFO 1 Slew</i>	<i>0</i>
<i>LFO 1 OneShot</i>	<i>Off</i>
<i>LFO 1 Common</i>	<i>Off</i>
LFO 2 Type	Triangle
LFO 2 Range	High
LFO 2 Rate	128
LFO 2 Fade Time	50
<i>LFO 2 Fade Mode</i>	<i>FadeIn</i>
<i>LFO 2 Phase</i>	<i>Free</i>
<i>LFO 2 Slew</i>	<i>0</i>
<i>LFO 2 OneShot</i>	<i>Off</i>
<i>LFO 2 Common</i>	<i>Off</i>
Envelopes	
Amp Env attack	2
Amp Env decay	90
Amp Env sustain	127
Amp Env release	40
<i>Amp Env Velocity</i>	<i>0</i>
<i>Amp Env MonoTrig</i>	<i>Legato</i>
Mod Env attack	2
Mod Env decay	75
Mod Env sustain	35
Mod Env release	45
Mod Env select	1
<i>Mod Env 1 Velocity</i>	<i>0</i>
<i>Mod Env 1 MonoTrig</i>	<i>Re-Trig</i>
<i>Mod Env 2 Velocity</i>	<i>0</i>
<i>Mod Env 2 MonoTrig</i>	<i>Re-Trig</i>
Distortion	
Distortion level	0
Effects	
Bypass	Off
Delay Feedback	64
Delay Time	64
Delay Level	0
Delay Sync	Off
<i>Delay SyncRate</i>	<i>16th</i>
<i>Delay LP Damp</i>	<i>85</i>

Modulation Matrix – sources

The table below lists the sources of modulation available to Inputs A and B of each Slot in the Modulation Matrix.

Display	Controlling Parameter
Direct	The Depth control ([57]; select Row 3)
ModWheel	Mod Wheel
AftTouch	Keyboard aftertouch
ExprPED1	Expression pedal connected at PEDAL 1 input
BrthPED2	Expression pedal connected at PEDAL 2 input
Velocity	Keyboard velocity
Keyboard	Key position on keyboard
Lfo1+	LFO 1 waveform varies controlled parameter in a positive sense
Lfo1+/-	LFO 1 waveform varies controlled parameter both positively and negatively
Lfo2+	LFO 2 waveform varies controlled parameter in a positive sense
Lfo2+/-	LFO 2 waveform varies controlled parameter both positively and negatively
AmPEnv	Amplitude envelope
ModEnv1	Modulation envelope 1
ModEnv2	Modulation envelope 2
Animate1	Animate Button 1
Animate2	Animate Button 2
CV +/-	CV input varies controlled parameter both positively and negatively

Modulation Matrix – destinations

The table below lists the destinations to which each Slot of the Modulation Matrix may be routed.

Display	Controlling Source
O123Ptch	Frequency of all three oscillators
Osc1Ptch	Oscillator 1 frequency
Osc2Ptch	Oscillator 2 frequency
Osc3Ptch	Oscillator 3 frequency
Osc1VSync	Oscillator 1 VSync level
Osc2VSync	Oscillator 2 VSync level
Osc3VSync	Oscillator 3 VSync level
Osc1Shpe	Oscillator 1 Shape Amount
Osc2Shpe	Oscillator 2 Shape Amount
Osc3Shpe	Oscillator 3 Shape Amount
Osc1 Lev	Oscillator 1 level
Osc2 Lev	Oscillator 2 level
Osc3 Lev	Oscillator 3 level
NoiseLev	Noise source level
Ring Lev	Ring Modulator output level (RM inputs are Osc 1 and Osc 2)
VcaLevel	Overall synth output level
Filt Drv	Pre-filter Overdrive
FiltDist	Post-filter Distortion
FiltFreq	Filter cut-off frequency (or centre frequency when Shape=BP)
Filt Res	Filter Resonance
Lfo1Rate	LFO 1 frequency
Lfo2Rate	LFO 2 frequency
AmPEnv A	Attack time of Amplitude envelope
AmPEnv D	Decay time of Amplitude envelope
AmPEnv R	Release time of Amplitude envelope
ModEnv1A	Attack time of Modulation envelope 1
ModEnv1D	Decay time of Modulation envelope 1
ModEnv1R	Release time of Modulation envelope 1
ModEnv2A	Attack time of Modulation envelope 2
ModEnv2D	Decay time of Modulation envelope 2
ModEnv2R	Release time of Modulation envelope 2
FM O1>O2	Depth of Frequency modulation applied to Oscillator 2 by Oscillator 1*
FM O2>O3	Depth of frequency modulation applied to Oscillator 3 by Oscillator 2*
FM O3>O1	Depth of frequency modulation applied to Oscillator 1 by Oscillator 3*
FM Ns>O1	Amount of noise modulation applied to Oscillator 1*
O3>FiltF	Degree of control of filter cut-off/centre frequency by Oscillator 3*
Ns>FiltF	Degree of control of filter cut-off/centre frequency by noise source*

* Note that only positive values of **Depth** are effective for the FM options; all negative values are considered as zero.

MIDI parameters list

Parameter	CC/ NRPN	Control Number.	Range	Default Value
Patch Category	NRPN	0:0	0-14	0
Patch Genre	NRPN	0:1	0-9	0
Voice Mode	NRPN	0:2	0-4	0
Voice Unison	NRPN	0:3	0-4	0
Voice Unison Detune	NRPN	0:4	0-127	25
Voice Unison Spread	NRPN	0:5	0-127	0
Voice Keyboard Octave	NRPN	0:6	61-67 (-3 to +3)	64 (0)
Glide Time	CC	5	0-127 (0 to +127)	0 (60)
Voice Pre-Glide	NRPN	7	52-76 (-12 to +12)	64 (Off)
Glide On	CC	35	0-1 (0 to +1)	0 (0)
Oscillators				
Osc Common Divergence	NRPN	0:9	0-127 (0 to +127)	0 (0)
Osc Common Drift	NRPN	0:10	0-127 (0 to +127)	0 (0)
Osc Common Noise LPF	NRPN	0:11	0-127 (0 to +127)	0 (127)
Osc Common Noise HPF	NRPN	0:12	0-0 (to+)	(0)
Oscillator 1 Range	CC	3	63-66 (-1 to +2)	64 (0)
Oscillator 1 Coarse	CC pair	14,46	0-255 (-128 to +127)	128 (0)
Oscillator 1 Fine	CC pair	15,47	28-228 (-100 to +100)	128 (0)
Oscillator 1 ModEnv2 > Pitch	CC	9	1-127 (-63 to +63)	64 (0)
Oscillator 1 LFO2 > Pitch	CC pair	16,48	1-255 (-127 to +127)	128 (0)
Oscillator 1 Wave	NRPN	0:14	0-4 (0 to +4)	0 (2)
Oscillator 1 Wave More	NRPN	0:15	4-20 (4 to +20)	0 (4)
Oscillator 1 Shape Source	NRPN	0:16	0-2 (0 to +2)	0 (0)
Oscillator 1 Manual Shape	CC	12	0-127 (-64 to +63)	64 (0)
Oscillator 1 ModEnv1 > Shape	CC	119	0-127 (-64 to +63)	64 (0)
Oscillator 1 LFO1 > Shape	CC	33	0-127 (-64 to +63)	64 (0)
Oscillator 1 Vsync	CC	34	0-127 (0 to +127)	0 (0)
Oscillator 1 Saw Density	NRPN	0:17	0-127 (0 to +127)	0 (0)
Oscillator 1 Saw Density Detune	NRPN	0:18	0-127 (0 to +127)	0 (64)
Oscillator 1 Fixed Note	NRPN	0:19	0-88 (0 to +88)	0 (Off)
Oscillator 1 Bend Range	NRPN	0:20	40-88 (-24 to +24)	64 (12)
Oscillator 2 Range	CC	37	63-66 (-1 to +2)	64 (0)
Oscillator 2 Coarse	CC pair	17,49	0-255 (-128 to +127)	128 (0)
Oscillator 2 Fine	CC pair	18,50	28-228 (-100 to +100)	128 (0)
Oscillator 2 ModEnv2 > Pitch	CC	38	1-127 (-63 to +63)	64 (0)
Oscillator 2 LFO2 > Pitch	CC pair	19,51	1-255 (-127 to +127)	128 (0)
Oscillator 2 Wave	NRPN	0:23	0-4 (0 to +4)	0 (2)
Oscillator 2 Wave More	NRPN	0:24	8-24 (4 to +20)	4 (4)
Oscillator 2 Shape Source	NRPN	0:25	0-2 (0 to +2)	0 (0)
Oscillator 2 Manual Shape	CC	39	0-127 (-64 to +63)	64 (35)
Oscillator 2 ModEnv1 > Shape	CC	40	0-127 (-64 to +63)	64 (0)
Oscillator 2 LFO1 > Shape	CC	41	0-127 (-64 to +63)	64 (0)
Oscillator 2 Vsync	CC	42	0-127 (0 to +127)	0 (0)

Parameter	CC/ NRPN	Control Number.	Range	Default Value
Oscillator 2 Saw Density	NRPN	0:26	0-127 (0 to +127)	0 (0)
Oscillator 2 Saw Density Detune	NRPN	0:27	0-127 (0 to +127)	0 (64)
Oscillator 2 Fixed Note	NRPN	0:28	0-88 (0 to +88)	0 (Off)
Oscillator 2 Bend Range	NRPN	0:29	40-88 (-24 to +24)	64 (12)
Oscillator 3 Range	CC	65	63-66 (-1 to +2)	64 (-1)
Oscillator 3 Coarse	CC pair	20,52	0-255 (-128 to +127)	128 (0)
Oscillator 3 Fine	CC pair	21,53	28-228 (-100 to +100)	128 (0)
Oscillator 3 ModEnv2 > Pitch	CC	43	1-127 (-63 to +63)	64 (0)
Oscillator 3 LFO2 > Pitch	CC pair	22,54	1-255 (-127 to +127)	128 (0)
Oscillator 3 Wave	NRPN	0:32	0-4 (0 to +4)	0 (2)
Oscillator 3 Wave More	NRPN	0:33	8-24 (4 to +20)	4 (4)
Oscillator 3 Shape Source	NRPN	0:34	0-2 (0 to +2)	0 (0)
Oscillator 3 Manual Shape	CC	71	0-127 (-64 to +63)	64 (0)
Oscillator 3 ModEnv1 > Shape	CC	72	0-127 (-64 to +63)	64 (0)
Oscillator 3 LFO1 > Shape	CC	73	0-127 (-64 to +63)	64 (0)
Oscillator 3 Vsync	CC	44	0-127 (0 to +127)	0 (0)
Oscillator 3 Saw Density	NRPN	0:35	0-127 (0 to +127)	0 (0)
Oscillator 3 Saw Density Detune	NRPN	0:36	0-127 (0 to +127)	0 (64)
Oscillator 3 Fixed Note	NRPN	0:37	0-88 (0 to +88)	0 (Off)
Oscillator 3 Bend Range	NRPN	0:38	40-88 (-24 to +24)	64 (12)
Mixer				
Mixer Osc1	CC pair	23,55	0-255 (0 to +255)	0 (255)
Mixer Osc2	CC pair	24,56	0-255 (0 to +255)	0 (0)
Mixer Osc3	CC pair	25,57	0-255 (0 to +255)	0 (0)
Mixer Ring 1*2	CC pair	26,58	0-255 (0 to +255)	0 (0)
Mixer Noise	CC pair	27,59	0-255 (0 to +255)	0 (0)
Mixer Patch Level	NRPN	0:41	0-127 (0 to +127)	0 (0)
Mixer VCA Gain	NRPN	0:42	0-127 (0 to +127)	0 (127)
Mixer Dry Level	NRPN	0:43	0-127 (0 to +127)	0 (127)
Mixer Wet Level	NRPN	0:44	0-127 (0 to +127)	0 (127)
Filter				
Filter Overdrive	CC	80	0-127 (0 to +127)	0 (0)
Filter Post Drive	CC	36	0-127 (0 to +127)	0 (0)
Filter Slope	NRPN	0:45	0-1 (0 to +1)	0 (1)
Filter Shape	NRPN	0:46	0-2 (0 to +2)	0 (0)
Filter Key Tracking	CC	75	0-127 (0 to +127)	0 (127)
Filter Resonance	CC	79	0-127 (0 to +127)	0 (0)
Filter Frequency	CC pair	29,61	0-255 (0 to +255)	0 (255)
Filter LFO1 > Filter	CC pair	28,60	1-255 (-127 to +127)	128 (128)
Filter Osc3 > Filter	CC	76	0-127 (0 to +127)	0 (0)
Filter Env Select	NRPN	0:47	0-1 (0 to +1)	0 (1)
Filter AmpEnv > Filter	CC	77	1-127 (-63 to +63)	64 (0)

Parameter	CC/ NRPN	Control Number.	Range	Default Value
Filter ModEnv1 > Filter	CC	78	1-127 (-63 to +63)	64 (0)
Filter Divergence	NRPN	0:48	0-127 (0 to +127)	0 (0)
Envelopes				
Amp Envelope Attack	CC	86	0-127 (0 to +127)	0 (2)
Amp Envelope Decay	CC	87	0-127 (0 to +127)	0 (90)
Amp Envelope Sustain	CC	88	0-127 (0 to +127)	0 (127)
Amp Envelope Release	CC	89	0-127 (0 to +127)	0 (40)
Amp Envelope Velocity	NRPN	0:55	0-127 (-64 to +63)	64 (0)
Amp Envelope Trigger	NRPN	0:56	0-1 (0 to +1)	0 (1)
Mod Envelope Select	NRPN	0:59	0-1 (0 to +1)	0 (0)
Mod Envelope 1 Attack	CC	90	0-127 (0 to +127)	0 (2)
Mod Envelope 1 Decay	CC	91	0-127 (0 to +127)	0 (75)
Mod Envelope 1 Sustain	CC	92	0-127 (0 to +127)	0 (35)
Mod Envelope 1 Release	CC	93	0-127 (0 to +127)	0 (45)
Mod Envelope 1 Velocity	NRPN	0:60	0-127 (-64 to +63)	64 (0)
Mod Envelope 1 Trigger	NRPN	0:61	0-1 (0 to +1)	0 (1)
Mod Envelope 2 Attack	CC	94	0-127 (0 to +127)	0 (2)
Mod Envelope 2 Decay	CC	95	0-127 (0 to +127)	0 (75)
Mod Envelope 2 Sustain	CC	117	0-127 (0 to +127)	0 (35)
Mod Envelope 2 Release	CC	103	0-127 (0 to +127)	0 (45)
Mod Envelope 2 Velocity	NRPN	0:64	0-127 (-64 to +63)	64 (0)
Mod Envelope 2 Trigger	NRPN	0:65	0-1 (0 to +1)	0 (1)
LFOs				
LFO 1 Range	NRPN	0:68	0-2 (0 to +2)	0 (0)
LFO 1 Rate	CC pair	30,62	0-255 (0 to +255)	0 (64)
LFO 1 Sync Rate	CC	81	0-34 (0 to +34)	0 (12)
LFO 1 Wave	NRPN	0:69	0-3 (0 to +3)	0 (0)
LFO 1 Phase	NRPN	0:70	0-120 (0 to +120)	0 (0)
LFO 1 Slew	NRPN	0:71	0-127 (0 to +127)	0 (0)
LFO 1 Fade Time	CC	82	0-127 (0 to +127)	0 (0)
LFO 1 Fade In/Out	NRPN	0:72	0-3 (0 to +3)	0 (0)
LFO 1 One Shot	NRPN	0:75	0-1 (0 to +1)	0 (0)
LFO 1 Common	NRPN	0:76	0-1 (0 to +1)	0 (0)
LFO 2 Range	CC	83	0-2 (0 to +2)	0 (0)
LFO 2 Rate	CC pair	31,63	0-255 (0 to +255)	0 (64)
LFO 2 Sync Rate	CC	84	0-34 (0 to +34)	0 (12)
LFO 2 Wave	NRPN	0:78	0-3 (0 to +3)	0 (0)
LFO 2 Phase	NRPN	0:79	0-120 (0 to +120)	0 (0)
LFO 2 Slew	NRPN	0:80	0-127 (0 to +127)	0 (0)
LFO 2 Fade Time	CC	85	0-127 (0 to +127)	0 (0)
LFO 2 Fade In/Out	NRPN	0:81	0-3 (0 to +3)	0 (0)
LFO 2 One Shot	NRPN	0:84	0-1 (0 to +1)	0 (0)
LFO 2 Common	NRPN	0:85	0-1 (0 to +1)	0 (0)

Parameter	CC/ NRPN	Control Number.	Range	Default Value
Effects				
Distortion Level	CC	104	0-127 (0 to +127)	0 (0)
Effects Master Bypass	NRPN	0:88	0-1 (0 to +1)	0 (0)
Effects Routing	NRPN	0:89	0-6 (0 to +6)	0 (0)
Delay Level	CC	108	0-127 (0 to +127)	0 (0)
Delay Time	CC	109	0-127 (0 to +127)	0 (64)
Delay Width	NRPN	0:92	0-127 (0 to +127)	0 (64)
Delay Sync	NRPN	0:93	0-1 (0 to +1)	0 (0)
Delay Sync Time	NRPN	0:94	0-18 (0 to +18)	0 (4)
Delay Feedback	CC	110	0-127 (0 to +127)	0 (64)
Delay Low Pass	NRPN	0:95	0-127 (0 to +127)	0 (64)
Delay High Pass	NRPN	0:96	0-127 (0 to +127)	0 (0)
Delay Slew	NRPN	0:97	0-127 (0 to +127)	0 ()
Reverb Level	CC	112	0-127 (0 to +127)	0 (0)
Reverb Type	NRPN	0:101	0-2 (0 to +2)	0 (0)
Reverb Time	CC	113	0-127 (0 to +127)	0 (90)
Reverb Damping LF	NRPN	0:102	0-127 (0 to +127)	0 (50)
Reverb Damping HF	NRPN	0:103	0-127 (0 to +127)	0 (1)
Reverb Size	NRPN	0:104	0-127 (0 to +127)	0 (90)
Reverb Mod	NRPN	0:105	0-127 (0 to +127)	0 (64)
Reverb Mod Rate	NRPN	0:106	0-127 (0 to +127)	0 (4)
Reverb Low Pass	NRPN	0:107	0-127 (0 to +127)	0 (74)
Reverb High Pass	NRPN	0:108	0-127 (0 to +127)	0 (0)
Reverb Pre Delay	NRPN	0:109	0-127 (0 to +127)	0 (40)
Chorus Level	CC	105	0-127 (0 to +127)	0 (0)
Chorus Type	NRPN	0:111	0-2 (0 to +2)	0 (1)
Chorus Rate	CC	118	0-127 (0 to +127)	0 (20)
Chorus Mod Depth	NRPN	0:112	0-127 (0 to +127)	0 (64)
Chorus Feedback	CC	107	0-127 (-64 to +63)	64 (0)
Chorus LP	NRPN	0:113	0-127 (0 to +127)	0 (90)
Chorus HP	NRPN	0:114	0-127 (0 to +127)	0 (2)
ARP				
Arp/Clock Tempo	NA	NA:NA	40-240 (40 to +240)	0 (120)
Arp/Clock Sync Rate	NRPN	0:116	0-18 (0 to +18)	0 (16th)
Arp/Clock Type	NRPN	0:117	0-6 (0 to +6)	0 (0)
Arp/Clock Rhythm	NRPN	0:118	0-32 (0 to +32)	0 (0)
Arp/Clock Octave	NRPN	0:119	0-5 (0 to +5)	0 (0)
Arp/Clock Gate	CC	116	0-127 (0 to +127)	0 (64)
Arp/Clock Swing	NRPN	0:120	20-80 (20 to +80)	0 (50)
Arp/Clock On	NRPN	0:121	0-1 (0 to +1)	0 (0)
Arp/Clock Key Latch	NRPN	0:122	0-1 (0 to +1)	0 (0)
Arp/Clock Key Sync	NRPN	0:123	0-1 (0 to +1)	0 (0)
Animate 1 Hold	CC	114	0-1 (0 to +1)	0 (0)
Animate 2 Hold	CC	115	0-1 (0 to +1)	0 (0)

Parameter	CC/ NRPN	Control Number.	Range	Default Value
Mod Matrix				
Mod Matrix Selection	NRPN	0:125	0-15 (0 to +15)	0 (0)
Mod Matrix 1 Source1	NRPN	1:0	0-16 (0 to +16)	0 (0)
Mod Matrix 1 Source2	NRPN	1:1	0-16 (0 to +16)	0 (0)
Mod Matrix 1 Depth	NRPN	1:2	0-127 (-64 to +63)	64 (0)
Mod Matrix 1 Destination	NRPN	1:3	0-36 (0 to +36)	0 (0)
Mod Matrix 2 Source1	NRPN	2:0	0-16 (0 to +16)	0 (0)
Mod Matrix 2 Source2	NRPN	2:1	0-16 (0 to +16)	0 (0)
Mod Matrix 2 Depth	NRPN	2:2	0-127 (-64 to +63)	64 (0)
Mod Matrix 2 Destination	NRPN	2:3	0-36 (0 to +36)	0 (0)
Mod Matrix 3 Source1	NRPN	3:0	0-16 (0 to +16)	0 (0)
Mod Matrix 3 Source2	NRPN	3:1	0-16 (0 to +16)	0 (0)
Mod Matrix 3 Depth	NRPN	3:2	0-127 (-64 to +63)	64 (0)
Mod Matrix 3 Destination	NRPN	3:3	0-36 (0 to +36)	0 (0)
Mod Matrix 4 Source1	NRPN	4:0	0-16 (0 to +16)	0 (0)
Mod Matrix 4 Source2	NRPN	4:1	0-16 (0 to +16)	0 (0)
Mod Matrix 4 Depth	NRPN	4:2	0-127 (-64 to +63)	64 (0)
Mod Matrix 4 Destination	NRPN	4:3	0-36 (0 to +36)	0 (0)
Mod Matrix 5 Source1	NRPN	5:0	0-16 (0 to +16)	0 (0)
Mod Matrix 5 Source2	NRPN	5:1	0-16 (0 to +16)	0 (0)
Mod Matrix 5 Depth	NRPN	5:2	0-127 (-64 to +63)	64 (0)
Mod Matrix 5 Destination	NRPN	5:3	0-36 (0 to +36)	0 (0)
Mod Matrix 6 Source1	NRPN	6:0	0-16 (0 to +16)	0 (0)
Mod Matrix 6 Source2	NRPN	6:1	0-16 (0 to +16)	0 (0)
Mod Matrix 6 Depth	NRPN	6:2	0-127 (-64 to +63)	64 (0)
Mod Matrix 6 Destination	NRPN	6:3	0-36 (0 to +36)	0 (0)
Mod Matrix 7 Source1	NRPN	7:0	0-16 (0 to +16)	0 (0)
Mod Matrix 7 Source2	NRPN	7:1	0-16 (0 to +16)	0 (0)
Mod Matrix 7 Depth	NRPN	7:2	0-127 (-64 to +63)	64 (0)
Mod Matrix 7 Destination	NRPN	7:3	0-36 (0 to +36)	0 (0)
Mod Matrix 8 Source1	NRPN	8:0	0-16 (0 to +16)	0 (0)
Mod Matrix 8 Source2	NRPN	8:1	0-16 (0 to +16)	0 (0)
Mod Matrix 8 Depth	NRPN	8:2	0-127 (-64 to +63)	64 (0)
Mod Matrix 8 Destination	NRPN	8:3	0-36 (0 to +36)	0 (0)
Mod Matrix 9 Source1	NRPN	9:0	0-16 (0 to +16)	0 (0)
Mod Matrix 9 Source2	NRPN	9:1	0-16 (0 to +16)	0 (0)
Mod Matrix 9 Depth	NRPN	9:2	0-127 (-64 to +63)	64 (0)
Mod Matrix 9 Destination	NRPN	9:3	0-36 (0 to +36)	0 (0)
Mod Matrix 10 Source1	NRPN	10:0	0-16 (0 to +16)	0 (0)
Mod Matrix 10 Source2	NRPN	10:1	0-16 (0 to +16)	0 (0)
Mod Matrix 10 Depth	NRPN	10:2	0-127 (-64 to +63)	64 (0)
Mod Matrix 10 Destination	NRPN	10:3	0-36 (0 to +36)	0 (0)
Mod Matrix 11 Source1	NRPN	11:0	0-16 (0 to +16)	0 (0)
Mod Matrix 11 Source2	NRPN	11:1	0-16 (0 to +16)	0 (0)
Mod Matrix 11 Depth	NRPN	11:2	0-127 (-64 to +63)	64 (0)
Mod Matrix 11 Destination	NRPN	11:3	0-36 (0 to +36)	0 (0)
Mod Matrix 12 Source1	NRPN	12:0	0-16 (0 to +16)	0 (0)
Mod Matrix 12 Source2	NRPN	12:1	0-16 (0 to +16)	0 (0)
Mod Matrix 12 Depth	NRPN	12:2	0-127 (-64 to +63)	64 (0)

Parameter	CC/ NRPN	Control Number.	Range	Default Value
Mod Matrix 12 Destination	NRPN	12:3	0-36 (0 to +36)	0 (0)
Mod Matrix 13 Source1	NRPN	13:0	0-16 (0 to +16)	0 (0)
Mod Matrix 13 Source2	NRPN	13:1	0-16 (0 to +16)	0 (0)
Mod Matrix 13 Depth	NRPN	13:2	0-127 (-64 to +63)	64 (0)
Mod Matrix 13 Destination	NRPN	13:3	0-36 (0 to +36)	0 (0)
Mod Matrix 14 Source1	NRPN	14:0	0-16 (0 to +16)	0 (0)
Mod Matrix 14 Source2	NRPN	14:1	0-16 (0 to +16)	0 (0)
Mod Matrix 14 Depth	NRPN	14:2	0-127 (-64 to +63)	64 (0)
Mod Matrix 14 Destination	NRPN	14:3	0-36 (0 to +36)	0 (0)
Mod Matrix 15 Source1	NRPN	15:0	0-16 (0 to +16)	0 (0)
Mod Matrix 15 Source2	NRPN	15:1	0-16 (0 to +16)	0 (0)
Mod Matrix 15 Depth	NRPN	15:2	0-127 (-64 to +63)	64 (0)
Mod Matrix 15 Destination	NRPN	15:3	0-36 (0 to +36)	0 (0)
Mod Matrix 16 Source1	NRPN	16:0	0-16 (0 to +16)	0 (0)
Mod Matrix 16 Source2	NRPN	16:1	0-16 (0 to +16)	0 (0)
Mod Matrix 16 Depth	NRPN	16:2	0-127 (-64 to +63)	64 (0)
Mod Matrix 16 Destination	NRPN	16:3	0-36	0

