

wavestate

WAVE SEQUENCING SYNTHESIZER

wavestate mkII

WAVE SEQUENCING SYNTHESIZER

wavestate SE

WAVE SEQUENCING SYNTHESIZER

wavestate module

WAVE SEQUENCING SYNTHESIZER

Owner's Manual

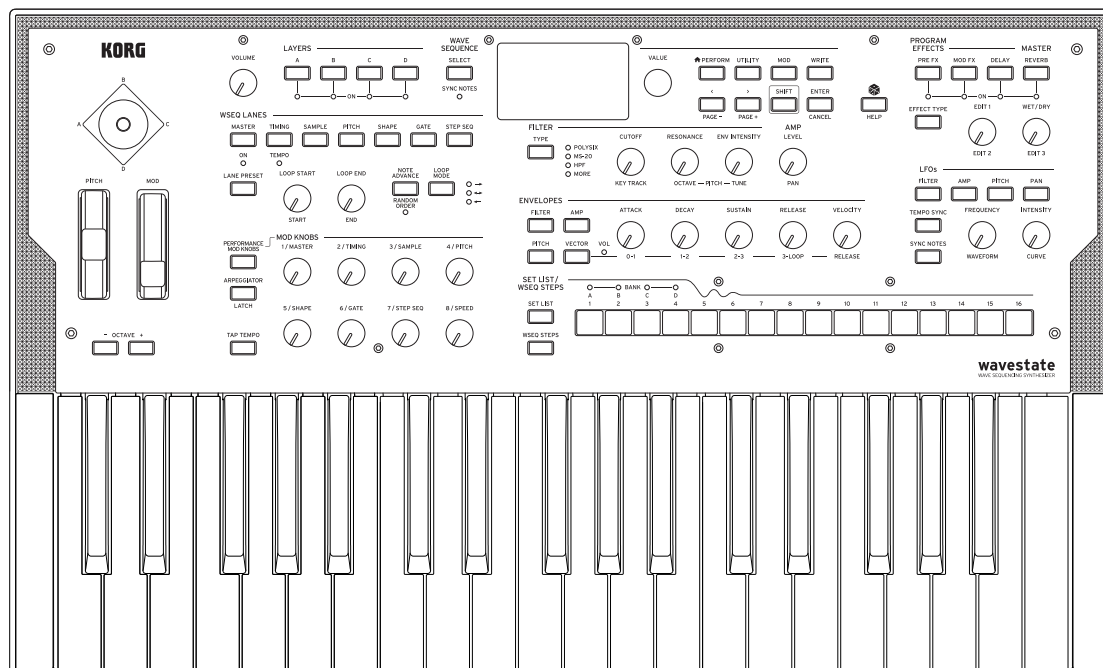

KORG

Contents

Getting Started	1
References to different wavestate models	1
About the wavestate manuals	1
If you don't usually read manuals.....	1
Navigation	1
SHIFT	2
ENTER for accelerated editing	2
Modulation	3
Mod Knobs	3
Help pages	3
Structure	3
Selecting and Playing Sounds	4
Selecting Sounds	4
Selecting Performances from the display	4
Selecting from lists	4
Using Set Lists	6
Assigning a Performance to a Set List Slot	7
Saving Set Lists	7
Using Note Trigger (module only)	8
Basic Editing	9
Home Page (PERFORM)	9
Layer Programs	10
Velocity Zones	10
Keyboard Zones	11
Program Setup	12
Voice Assign	12
Layer Setup	14
Performance Setup	15
Write	17
Saving Sounds	17
Write Metadata	18
Name	18
Editing names	18
Compare	19
Using Compare	19
Delete from Database	19
Using Delete	19
Wave Sequencing 2.0	20
Overview	20
Wave Sequence editing	20
Editing Lanes	20
Editing Steps	21
Step Solo mode	21
Wave Sequence	21
Mode = Wave Sequence	22
Mode = Single Multisample	23
Master Lane	23
Front-Panel Lane Controls	24
Step Probability	24
Timing Lane probability	24
Timing	25
Timing Lane	25
Timing Lane Step	26
Sample	28
Sample Lane	28
Sample Lane Step	28
Pitch	29
Pitch Lane	29
Pitch Lane Step	30
Shape	31

Contents

Shape Lane	31
Shape Lane Step	31
Gate	32
Gate Lane	32
Gate Lane Step	32
Step Seq.	32
Step Seq Lane	32
Step Seq Lane Step	32
Wave Sequence Utility	33
Cut Steps, Copy Steps, Paste Steps, Insert Steps, Add Steps To End	33
Scale Timing	33
Vector	34
Overview	34
What does Vector mean?	34
Vector Joystick and Vector Envelope	34
Vector Volume Control and modulation	35
Vector and MIDI	35
Vector Env Volume	35
Vector Env X-Y	35
Vector Env Time	36
Vector Env Setup	36
Arpeggiator	38
Arpeggiator	38
Filter	40
Filter	40
2-Pole LP/HP/BP/BR	42
4-Pole LP/HP/BP/BR	42
MS-20 LP/HP and Polysix	42
Multi Filter	43
Multi Filter	43
What's a Multi Filter?	43
Manual	44
Filter Mod	44
Filter Key Track	45
Keyboard Track	45
How Key Track works: Keys and Slopes	46
Pitch	48
Pitch	48
Pitch Mod	49
Amp	51
Amp	51
Amp Key Track	52
Differences from Filter Keyboard Track	53
Modulation	54
Using Modulation	54
Modulation Overview	54
Adding Modulation Routings	54
Viewing and Editing Modulations	55
Mod Knobs	56
Modulation Sources	57
Controllers	57
Mod Knobs	58
Generators	58
CC +	59
CC +/-	60
Envelopes	61
Filter/Amp/Pitch Envelope	61
Filter/Amp/Pitch Env Curve	61
Filter/Amp/Pitch Envelope Trigger	62
LFOs	64
Filter/Amp/Pitch/Pan LFO	64
Filter/Amp/Pitch/Pan LFO Details	68
Modulation Processors	70

Contents

Overview	70
Gate	70
Offset	71
Quantize	72
Scale	73
Curve	73
Smooth	75
Sum	76
Effects	77
Overview	77
Main page	77
Level controls	77
Edit page	78
Pre FX	78
Decimator	78
Graphic EQ	78
Guitar Amp	78
Modern Compressor	78
Parametric EQ	78
Red Compressor	78
Ring Modulator	78
Tremolo	79
Wave Shaper	79
Mod FX	79
Black Chorus/Flanger	79
Black Phase	79
CX-3 Vibrato Chorus	79
EP Chorus	79
Harmonic Chorus	79
Modern Chorus	79
Modern Phaser	79
Orange Phase	79
Orange Phase V2	79
Polysix Ensemble	79
Small Phase	80
Talking Modulator	80
Vintage Chorus	80
Vintage Flanger	80
Vintage/Custom Wah	80
Vox Wah	80
Delay	80
L/C/R Delay	80
Multiband Mod Delay	80
Reverse Delay	80
Stereo/Cross Delay	80
Tape Echo	80
Master Reverb	81
Early Reflections	81
Overb	81
Master EQ	81
Randomize	82
Using Randomize	82
Utility	83
System Setup	83
MIDI & USB	84
Controllers	85
MIDI CC Assign	88
Global Scale	88
Preferences	90
System Stats	90
About	91
USB	92
MIDI	92

Contents

Editor/Librarian and Korg Sample Builder	92
Specifications	93
MIDI Implementation Chart	94

Getting Started

Thank you for purchasing the Korg wavestate Wave Sequencing Synthesizer.

References to different wavestate models

These manuals apply to all wavestate models with software version 3.0 or later, collectively referred to as “the wavestate.” The front panel and rear panel illustrations show the original wavestate, but they apply identically to the wavestate SE and wavestate mkII. The wavestate module has a slightly different control layout, but all functionality remains the same except as noted.

About the wavestate manuals

The documentation for the wavestate consists of the following:

- Precautions
- Quick Start Guide
- Owner’s Manual (what you’re reading now)

In this manual, the following text styles indicate:

- **FRONT PANEL CONTROLS**
- **Parameter Names**
- *Parameter Values*

If you don’t usually read manuals...

Even if you don’t usually read manuals, please read this section!

Navigation

Press a button or turn a knob, and the display will show the related page.

Some pages, like Amp and Pitch, are only displayed when turning knobs. Similarly, the **ARPEGGIATOR** button both edits a parameter and displays a page. To display these or any other pages without making an edit, hold **ENTER** and turn or press the related knob or button. The page will appear with the parameter selected, but the value will not be changed.

< > and **PAGE-/PAGE+**: These are the basic controls for moving around in the display. **<** and **>** cursor through parameters, and can also select items in lists.

Hold **SHIFT** to use **PAGE-** and **PAGE+**, which select pages in the display. There are page indicators in the upper right of the display; the filled-in circle shows the current page.



Getting Started

LAYER A/B/C/D: Layers contain a Program, and Arpeggiator, and a handful of other settings. The front panel edits one Layer at a time, as selected by these buttons. To turn a Layer on or off, hold **SHIFT** and press the Layer's button, or just double-press the button.

Most pages on the display apply only to the selected Layer. For these pages, the Layer's letter (A/B/C/D) is shown in the upper left of the display.

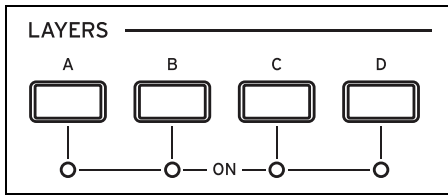

To go back to selecting sounds, press **PERFORM**. If you don't see the main page the first time, press **PERFORM** again; two presses will always bring you to the home page with the Performance name selected.

wavestate page map

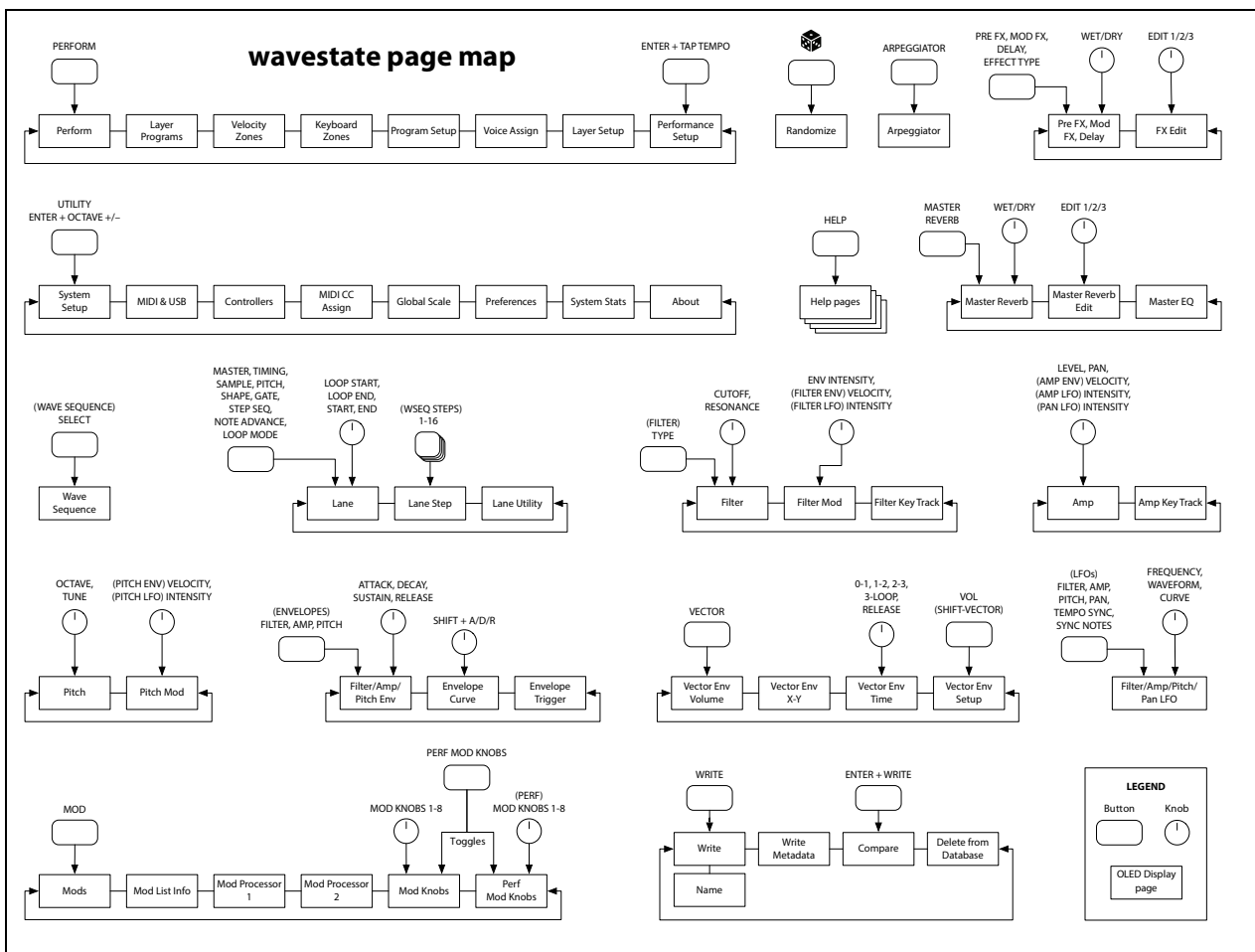

SHIFT

Hold down **SHIFT** to use alternative functions for knobs and buttons, labeled in blue text. For one-handed operation, double-press **SHIFT** to turn on Shift Hold; press again to turn off.

ENTER for accelerated editing

Hold down **ENTER** to accelerate editing or scrolling. For example:

- Normally, the **VALUE** knob works as a “fine” value input when moved slowly, with “coarse” bigger jumps when moved quickly. To restrict it to “coarse” value changes, hold **ENTER** while turning **VALUE**.
- Hold **ENTER** and press **<** or **>** (or turn the **VALUE** dial) to scroll by a whole page in a list, such as when selecting Performances, Multisamples, or Mod routings.

Getting Started

Modulation

Most front-panel knobs and on-screen parameters are modulatable. Hold **MOD** and press **>** to create a new modulation routing. When viewing and editing modulations, hold **MOD** and press **<** to filter the list. See the Mod List Info page for an on-screen list of shortcuts.

Mod Knobs

You can use the Mod Knobs in real-time performance, and also save the results as new sounds. The names are suggestions; they will do different things depending on the specific sound. The values are stored, and can themselves be modulated. Each Layer's Program has its own set of Mod Knobs, and an overall set of Performance Mod Knobs can control any or all Layers at once. Sometimes, one knob (such as **1/MASTER**) may enable the functionality of other knobs.

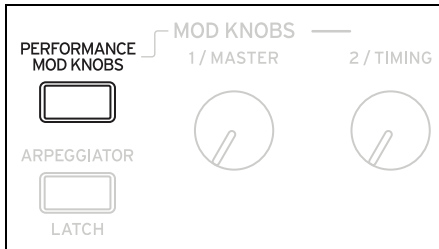

Help pages

Hold **SHIFT** and press the  (Randomize) button to bring up a set of pages containing shortcuts and usage tips.

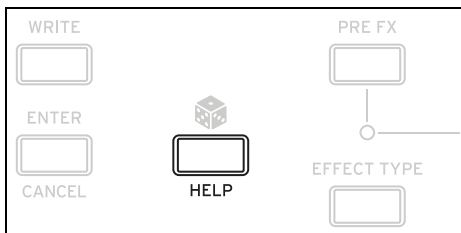

Structure

The wavestate plays one Performance at a time.

A Performance has four Layers, A...D, a Vector Envelope, and a master reverb and EQ.

Each Layer contains an Arpeggiator, a Program, and other settings such as MIDI channel, key and velocity zones, etc.

A Program includes a Wave Sequence or a single Multisample, a Filter, an Amp, a per-voice Vector Envelope, a set of modulators, a modulation matrix, and three effects: Pre FX, Mod FX, and Delay.

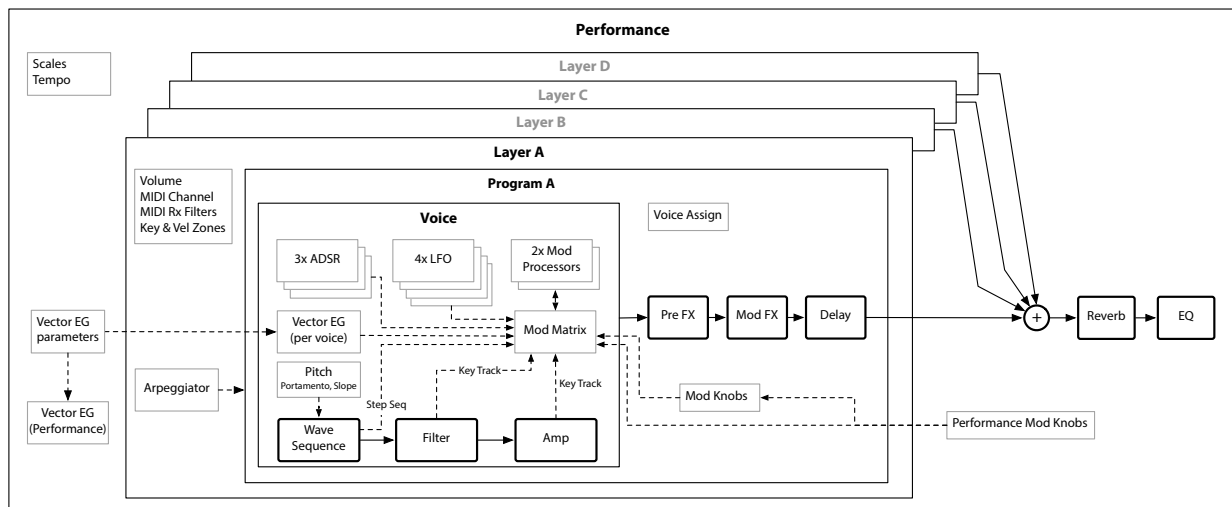

Selecting and Playing Sounds

Selecting Sounds

Selecting Performances from the display

1. Press the **PERFORM** button, and if necessary press it again.

Wherever you are in the system, the second press will always bring up the home page, with the large Performance name selected.



2. Follow the instructions under “Selecting from lists,” below.

Selecting from lists

Note: These instructions also apply to selecting Set Lists, Performances, Programs, Effects Presets, Wave Sequences, Multisamples, and Lane Presets.

1. Cursor to the item that you’d like to select.

For this example, we’ll use Performances, continuing from above.

2. Turn the **VALUE** knob or press **ENTER**.

A popup appears, showing a list of sounds.

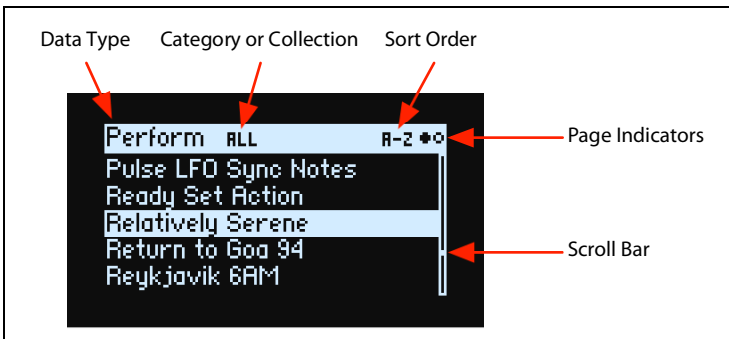

3. Turn the **VALUE** knob or use **<** and **>** to select sounds. Hold **ENTER** and press **<** or **>** to jump by 5.

You can play the sounds as you scroll through the list.

4. When you find a sound that you like, press **ENTER** again (or **SHIFT-ENTER** to cancel).

Using Categories

You can filter the list by sound category. To do so:

1. While the list is onscreen, press buttons 2 to 16 to select from the first 15 Categories.

The button for the selected Category is brightly lit; other valid buttons are dimly lit. Some data types (such as Motion Sequences) may have fewer than 15 Categories.

If there are fewer than 15 Categories for the current data type, only the valid buttons will be lit.

For Performances, Programs, and Multisamples, these first 15 Categories are designed to include all of the other Categories; see the tables below for details.

2. To show all sounds again, press button 1.

Selecting and Playing Sounds

Performance and Program Categories and buttons 1-16

Button	Category	Also shows these Categories
1	All	Shows everything, regardless of Category
2	Bass	
3	Lead	
4	Pad	Soundscape
5	Synth	Fast Synth
6	Bell/Mallet	
7	Gtr/Plucked	
8	Percussion	
9	Piano/Keys	
10	Brass	
11	Woodwind	
12	Strings	Orchestral
13	Vocal/Airy	
14	Seq	Arpeggio, Just 4 Fun, Rhythm Hard, Rhythm Soft
15	SFX	
16	User	

Multisample Categories and buttons 1-16

Button	Category	Also shows these Categories
1	All	Shows everything, regardless of Category
2	Bass	Ac Bass, E Bass, Bass FX
3	Lead	
4	Pad	
5	Synth	
6	Bell/Mallet	
7	Gtr/Plucked	Ac Guitar, E Guitar, Guitar FX, Plucked
8	Percussion	Kick, Snare, Drum, Cymbal
9	Piano/Keys	Ac Piano, E Piano, Keyboard, Organ
10	Brass	Brass Ens, Brass Solo
11	Woodwind	
12	Strings	String Ens, String Solo
13	Vocal/Airy	
14	Seq/Attack	Attack
15	SFX/Hits	Hits, Effects
16	User	

Using the on-screen Category list

Some data types, such as Performances, have more than 15 Categories. To view the full list:

1. In the list popup, hold **SHIFT** and press **PERFORM**.

The Category Select popup appears. The lists will vary depending on the data type.

2. Select the desired Category, and press **ENTER**.

The display returns to the list, showing only sounds in the selected Collection.

Using Collections

Collections are a different way of grouping sounds, separate from and in addition to Categories. For example, the factory Multisamples are grouped into a few Collections according to their origins. Third-party sound libraries might

Selecting and Playing Sounds

be marked as individual Collections. You can also create new Collections in the Editor/Librarian application, and use them for your own projects.

To filter the sound list by Collection:

1. In the list popup, hold **SHIFT** and press **>** (for **PAGE+**).

The Filters & Sort Order page appears.



2. Select the Collection parameter, and turn the **VALUE** knob or press **ENTER**.

The Collection Select popup appears. The lists will vary depending on the data type.

3. Select the desired Collection, and press **ENTER**.

The display returns to the list, showing only sounds in the selected Collection.

Using Sort Order

You can change the order in which sounds appear in the list. To do so:

1. In the list popup, press **PAGE+**.

The Filters & Sort Order page appears.

2. Select Sort Order, and turn the **VALUE** knob or press **ENTER**.

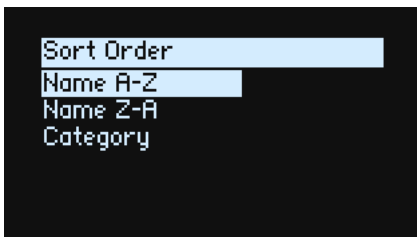

3. Choose the desired order.

You can choose from alphabetical (A-Z), reverse alphabetical (Z-A), or Category (sorted alphabetically within each Category).

Using Set Lists

Set Lists let you group and order Performances for gigs or projects. A Set List has 64 Slots, arranged into four banks A-D, corresponding to MIDI Program Change messages 1-64. Note that Set Lists don't contain separate copies of their sounds; they just point to Performances stored in the database.

To select sounds in the current Set List:

1. Press the **SET LIST** button, so that it is lit.
2. To select sounds in the current bank, press buttons 1-16.
3. To select from a different bank, double-press A/B/C/D (1/2/3/4). Alternatively, hold either **SHIFT** or **SET LIST** and then press A/B/C/D. Buttons 1-16 will then blink; press one to select a sound in the new bank.

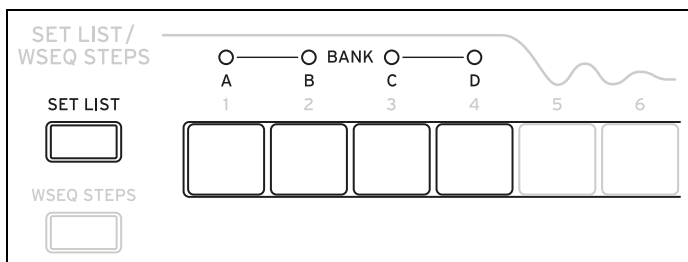

Selecting and Playing Sounds

If you select a sound using the display, buttons **1-16** will go dark. To return to the Set List, just press one of the buttons again.

You can store many different Set Lists, and switch between them as desired. To select a different Set List:

1. Press **UTILITY** twice, to go to the System Setup page.

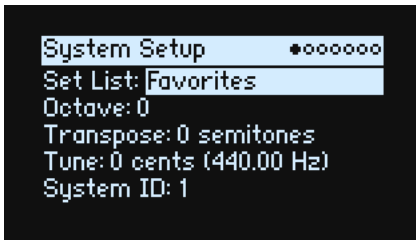

2. Select the Set List parameter, and press **ENTER** or turn the **VALUE** knob.

From this point, selecting Set Lists works just like selecting Performances, as described above.

Assigning a Performance to a Set List Slot

1. Select the Performance that you'd like to assign.
2. Press the **SET LIST** button, so that it is lit.
3. Hold **WRITE** and press the Slot to which you'd like to save.

The Write page appears, with that Slot already selected. To change the Slot, hold **WRITE** and press a different Slot button.

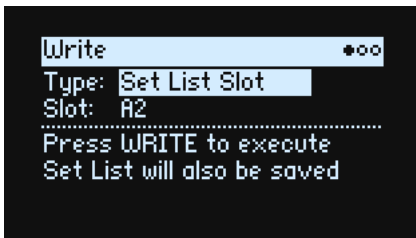

4. Press **WRITE**, and then **ENTER** to confirm.

The Set List will also be saved. If the Performance has been edited, you'll be prompted to save it too.

While you're on the Write page, you can also select a Slot from a different bank (for instance, if you're copying a Performance to a different Slot):

1. Hold **WRITE** and **SHIFT**, and press button **1-4** for the desired Bank.
2. Release **WRITE** and **SHIFT**.
3. Proceed to Step 3 above.

Saving Set Lists

To save the Set List:

1. Hold **WRITE** and press **SET LIST**.

The Write page appears, with the data type set to *Set List*.

2. To overwrite the existing Set List, press **WRITE**. To make a new copy and leave the existing Set List unchanged, press **SHIFT-WRITE**.
3. Press **ENTER** to confirm, or **SHIFT-ENTER** to cancel.

For more details, see "Saving Sounds" on page 17.

Using Note Trigger (module only)

Note Trigger lets you play sounds using the 1-16 buttons as an alternative keyboard—convenient if you don't have a full keyboard connected. Note Trigger is only available on the wavestate module.

To use Note Trigger:

1. Hold **SHIFT** and press **WSEQ STEPS**.

The Note Trigger page appears:

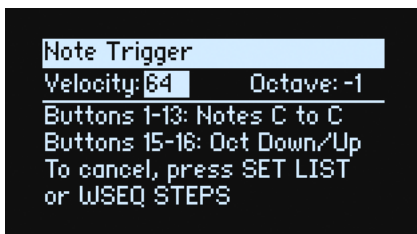

Buttons 1-13 illuminate to create a keyboard pattern from C to C, with dimmed lights showing the white keys.

2. To play notes, press buttons 1-13.
3. To change the octave, use buttons 15 (down) and 16 (up), or edit the Octave parameter on the display.
4. To set the velocity of the triggered notes, use the Velocity parameter.
5. To cancel Note Trigger, press either **SET LIST** or **WSEQ STEPS**.

While using Note Trigger, you can use almost all of the instrument as you would normally. There are a few exceptions:

- When selecting Performances, Programs, Wave Sequences, etc., the 1-16 buttons continue to function as Note Triggers, and so they are not available for selecting Categories.
- Entering a Wave Sequence editing page cancels Note Trigger, since the 1-16 buttons need to be used for Step selection.

Basic Editing

Home Page (PERFORM)

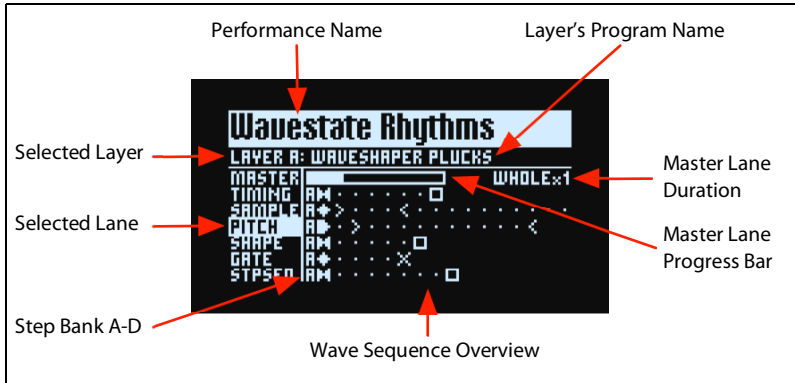

This is the wavestate’s main page, where you can select Performances, set the Layer’s Program, and see a real-time overview of the Layer’s Wave Sequence.

Wherever you are in the system, pressing **PERFORM** twice in row always returns here, with the Performance name selected.

Normally, using Lane controls or Mod Knobs takes you to the related pages in the display. The home page is an exception, so that you can change Lane settings and see the results in the Wave Sequence Overview, or use Mod Knobs while browsing through Performances.

The home page is also the only one on which the Page Indicators do not appear. Press **PAGE+** to go to the Layer Programs page.

Wave Sequence Overview

This shows the current state of the Layer’s newest sounding voice.

Note: Through modulation and probability, each voice in each Lane of each Wave Sequence may be on different steps, and may also have different Start/End/Loop Start/Loop End settings.

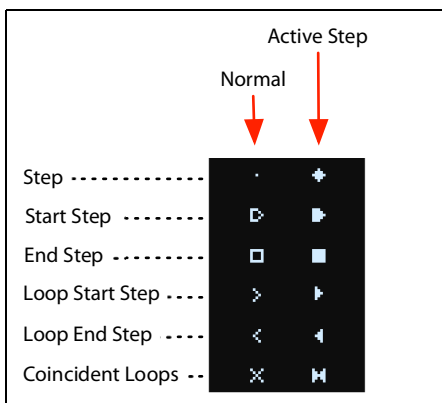

Master Lane Progress Bar

When enabled, the Master Lane restarts all of the other Lanes after either a specified number of beats or elapsed time; see “Master Lane” on page 23. This progress bar shows its current state.

Single Multisample display

When the Wave Sequence page **Mode** parameter is set to *Single Multisample*, the Multisample name is shown instead of the overview.

Layer Programs

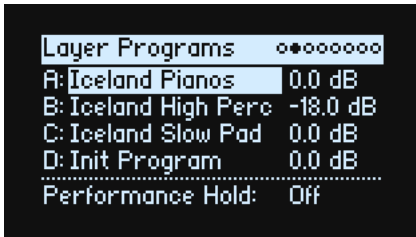

This page shows the Program selection and Volume for each Layer, as well as **Performance Hold**.

A...D (Programs A...D)

[List of Programs]

This selects the Program for the Layer.

(Volume A...D)

[-Inf, -84.9...+6.0 dB]

This controls the volume of the Layer (duplicating the Layer Setup page's **Volume** parameter). This is saved in the Performance, instead of the Program—so it's a good choice when balancing levels between Layers.

Performance Hold

[Off, On]

Use **Performance Hold** to hold notes or chords, leaving your hands free for knobs and modulation. This works differently from the Damper Pedal and the Program-level **Hold** parameter. When **Performance Hold** is *On*, notes or chords are held indefinitely until you play a new note or chord, at which point the previous notes are cut off and the new ones will sound.

Performance Hold applies only to Layers on the **Global MIDI Channel**.

The **ARPEGGIATOR** button LED shows both **Arpeggiator On/Off** and **Performance Hold On/Off**, as shown below. (See "Arpeggiator" on page 38.)

Arpeggiator button LED and Hold

	Hold Off	Hold On
Arpeggiator Off	LED off	LED blinks evenly
Arpeggiator On	LED on	LED blinks: long on, short off

Velocity Zones

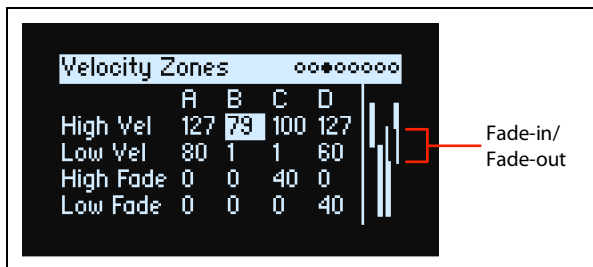

Shortcut: Pressing a **LAYER** button switches to the current parameter in the selected Layer's column.

High Vel (A...D), Low Vel (A...D)

[1...127]

These set the highest and lowest velocities on which the Layer will sound.

High Fade (A...D)

[0...126]

0: The **High Vel** acts as a hard split, with full volume on one side and silence on the other.

1...126: This lets you create a velocity crossfade. As velocity approaches the **High Vel**, the volume fades out gradually. **High Fade** sets the velocity range over which the fade-out occurs, working inwards from the **High Vel**.

Low Fade (A...D)

See “High Fade (A...D),” above.

Setting values from the keyboard

You can set velocities and note numbers directly from the keyboard, or via MIDI. This applies throughout the wavestate. To do so:

1. Select the velocity or note number parameter you'd like to edit.
2. Press and hold the **ENTER** button.
3. Play a note on the keyboard to set the parameter.
4. Release the **ENTER** button.

Keyboard Zones

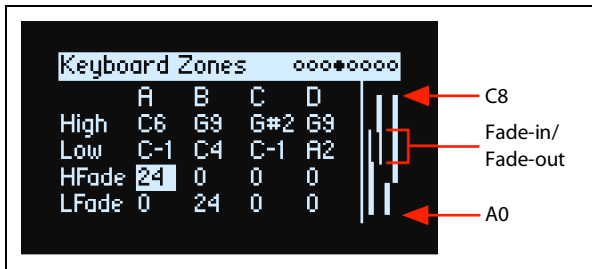

Shortcut: Pressing a **LAYER** button switches to the current parameter in the selected Layer's column.

High (A...D), Low (A...D)

[C-1...G9]

These set the highest and lowest notes on which the Layer will sound.

Note: The graphic shows only the standard range of 88 notes.

HFade (High Fade A...D)

[0...127]

0: The **High** key acts as a hard split, with full volume on one side and silence on the other.

1...127: This allows you to create a keyboard crossfade. As the notes approach the **High** key, the volume will fade out gradually. This sets the number of semitones over which the fade-out occurs, working inwards from the **High** key.

LFade (Low Fade A...D)

[0...127]

See “HFade (High Fade A...D),” above.

Program Setup

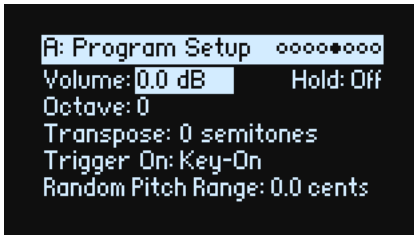
**Volume***[-Inf, -84.9...0.0 dB]*

This controls the overall volume of the Program, for volume-balancing with other sounds.

Octave*[-4...+4 octaves]*

This transposes the Program by up to four octaves up or down.

Transpose*[-12...+12 semitones]*

This transposes the Program by up to one octave, up or down, in semitones.

Trigger On*[Key-On, Key-Off]*

Key-On: This is the default setting, in which the Program is played when a key is pressed.

Key-Off: The Program will play as soon as you release the key. You can use this to create the “click” heard when a harpsichord note is released, for instance. In general, when using *Key-Off* it’s also best to set the Amp Envelope **Sustain** to 0.

Random Pitch Range*[0.0...50.0 cents]*

This parameter creates random variations in pitch for each note. At the default of 0.0, pitch will be completely stable; higher values create more randomization. This can be helpful for simulating instruments that have natural pitch instabilities, such as analog synths, tape-loop keyboards, or acoustic instruments.

Hold*[Off, On]*

Hold is like permanently pressing down on the sustain pedal. Notes continue to play as if you were holding down the key—even after you lift your fingers from the keyboard. If the sound is a looped Wave Sequence or a looped single sample, it will play continuously until you select a different sound.

Off: Notes will play normally. This is the default setting.

On: The sound will hold indefinitely.

Voice Assign

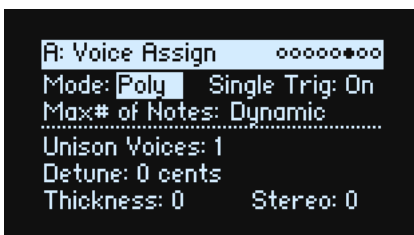
Mode = Poly

Basic Editing

(Voice Assign) Mode

[Poly, Mono]

This selects the basic voice allocation mode. Depending on which one you select, various other options will appear, such as **Single Trig** (*Poly* mode only) and **Mono Legato** and **Priority** (*Mono* mode only).

Poly: The Program will play polyphonically, allowing you play chords.

Mono: The Program will play monophonically, producing only one note at a time.

Single Trigger

[Off, On]

Single Trigger is available when **Voice Assign Mode** is set to *Poly*.

On: When you play the same note repeatedly, the previous note will be silenced before the next note is sounded, so that the two do not overlap.

Off: When you play the same note repeatedly, the notes will overlap.

Max # of Notes

[Dynamic, 1...64]

Max # of Notes is available when **Voice Assign Mode** is set to *Poly*.

Dynamic is the default. With this setting, you can play as many notes as the system allows.

1-64 limits the number of notes played by the Program. Voices will be allocated dynamically up to this maximum. You can use this to:

- Model the voice-leading of vintage synthesizers
- Control the resources required by individual Programs

This setting does not limit the **Unison Voices** parameter. For instance, if **Max # of Notes** is set to 6, and **Unison Voices** is set to 3, you can play up to 6 notes, each with 3 Unison voices.

Mode = Mono

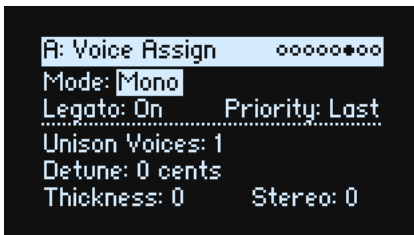

Mono Legato

[Off, On]

Mono Legato is available when **Voice Assign Mode** is set to *Mono*.

Legato means to play in a smooth, connected way; the next note is played before the last note is released.

On: The first note in a legato phrase will sound normally; subsequent notes in the phrase will sound smoother (for instance, envelopes will continue instead of restarting).

Off: Legato playing will produce the same sound as detached playing.

Priority

[Low, High, Last]

Priority is available when **Voice Assign Mode** is set to *Mono*.

This determines what happens when more than one note is being held down.

Low: The lowest note will sound. Many vintage monophonic analog synths work this way.

High: The highest note will sound.

Last: The most recently played note will sound.

Unison Voices

[1...16]

Unison can be used in both *Mono* and *Poly* modes.

1: Unison is off, and **Stereo Spread** and **Detune** do not apply.

Basic Editing

2-16: The Program uses the specified number of stacked, detuned voices to create a thicker sound.

Detune

[0...200 cents]

This parameter sets the tuning spread for the **Unison** voices.

Voices = 3, Detune = 24, Thickness Off

Voices	Detune
1	-12
2	0
3	+12

Voices = 4, Detune = 24, Thickness Off

Voices	Detune
1	-12
2	-4
3	+4
4	+12

Thickness

[0...100]

This parameter controls the character of the detuning for the unison voices.

0: Unison voices are evenly distributed across the **Detune** range, as shown above.

1...100: Unison voices are detuned asymmetrically. This makes the detuning more complex, and changes the way in which the pitches beat against one another—like slightly out-of-tune oscillators in a vintage synthesizer. Higher numbers increase the effect.

Stereo (Spread)

[0...100]

Stereo lets you create a wider stereo field when using **Unison**. It applies only when **Unison Voices** is 2 or greater.

Layer Setup

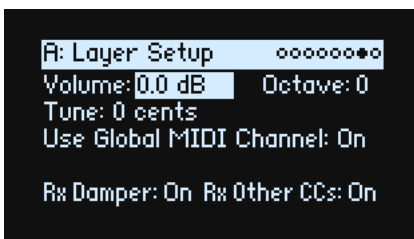

Volume

[-Inf, -84.9...+6.0 dB]

This controls the volume of the Layer. Note that this is saved in the Performance, but not with the Program—so it's a good choice when balancing levels between Layers.

Octave

[-3...+3]

This transposes the Layer by 3 octaves, up or down.

Basic Editing

Tune

[-100...+100 cents]

This lets you detune the Layer by up to 100 cents (1/100 of a semitone), up or down.

Use Global MIDI Channel

[Off, On]

On: This is the default. The Layer will play from the built-in keyboard, and receive on the **Global Channel**.

Off: The Layer will receive on the channel specified below, and will not play from the built-in keyboard.

MIDI Channel

[1...16]

This is shown only if **Use Global MIDI Channel** is *Off*. It sets the channel on which the Layer will receive MIDI.

Rx Damper

[Off, On]

On: This is the default. The Layer will respond to the connected damper pedal and to MIDI CC#64.

Off: The Layer will ignore both the connected damper pedal and MIDI CC#64.

Rx Other CCs

[Off, On]

On: This is the default. The Layer will respond normally to MIDI CCs.

Off: The Layer will ignore all MIDI CCs (except for CC#64), as well as Aftertouch, Poly Aftertouch, and Pitch Bend.

Performance Setup



Volume

[-Inf, -84.9...0.0 dB]

This controls the Performance volume, for balancing levels with other sounds.

Octave

[-2...+2]

This transposes the entire Performance by 2 octaves, up or down.

Tempo (TAP TEMPO)

[40.00...300.00]

This sets the tempo for the Performance. To show this parameter without changing the value, use **ENTER + TAP TEMPO**.

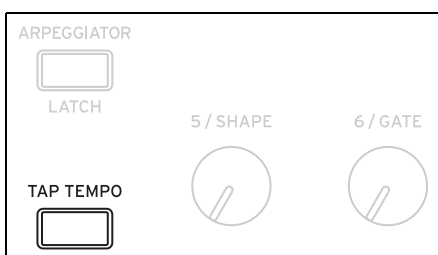

Basic Editing

Transpose

[-12...+12]

This transposes the entire Performance by 12 semitones, up or down.

Perf Scale

[Off, On]

On: The Performance Scale settings, below, are used—unless **Global Scale** is *On*, in which case the Global scales are used instead.

Off: The Performance Scale settings are ignored.

Active Scale, 1 (Scale 1), (Key), 2 (Scale 2), (Key)

For details on the scale parameters, see “Global Scale” on page 88.

Write

Saving Sounds

The Performance, with its four Layers, is the main way of selecting, editing, and saving sounds. While you can save Programs, Wave Sequences, and Wave Sequence Lane Presets, you don't have to do so: all data is contained in the Performance.

Similarly, when you load any of these data types into a Performance, a new copy of the data is created in the Performance. Any edits affect only the local copy inside the Performance, and not the original data. This lets you edit freely without worrying about affecting other sounds.

To save:

1. Press the **WRITE** button.

The Write page appears, with the type of data to write shown at the top of the page. By default, this is set to *Performance*.

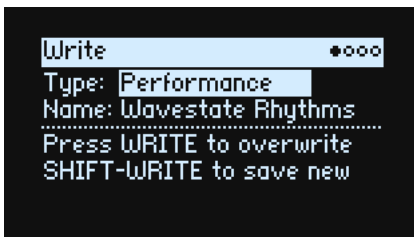

2. To choose a different data type, hold **WRITE** and press a button such as **LAYER A/B/C/D** (for Programs), **SET LIST**, or **WAVE SEQUENCE**, or set the Type manually in the display.

For Programs, Wave Sequences, and Lanes, another parameter will appear: **From** (*Layer A...D*). For example, if **Type** is *Timing Lane*, and **From** is set to *Layer B*, Write will save the Timing Lane from Layer B. This defaults to the currently selected Layer, but you can change it if desired.

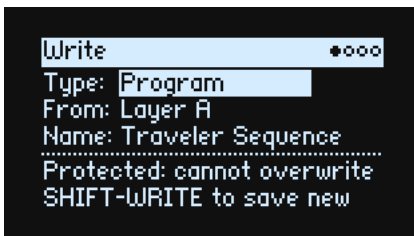

3. If necessary, set the From parameter to the desired Layer, either on-screen or by pressing one of the **LAYER** buttons.
4. Optionally, cursor to the name and press **ENTER**.

This brings up the Text Edit page.

5. To edit the name, use **<** or **>** to move back and forth, and **VALUE** to change the selected character. **SHIFT** changes character sets. Press **ENTER** when you're done.

Important: changing the name does not automatically make a new copy of the sound!

6. To overwrite the existing sound, press **WRITE**. To make a new copy and leave the existing sound unchanged, press **SHIFT-WRITE**.
7. Press **ENTER** to confirm, or **SHIFT-ENTER** to cancel.

Factory sounds may be write-protected, in which case only "save new" is available.

Warning: Never turn off the power while data is being saved. Doing so may destroy the internal data.

Write Metadata

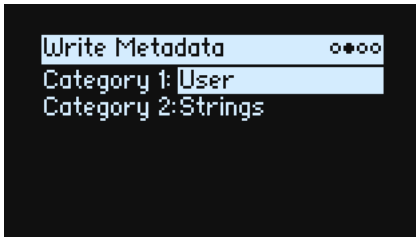

The second page under Write allows you to select two Categories for the saved item. When searching by Category, a sound will be shown if either of its Categories match the search criteria.

Note: When **Type** is set to *Set List Slot*, this page is not available.

Category 1/2

[List of Categories]

Each object type—Performances, Programs, Multisamples, etc.—has its own list of Categories. Note that only the first 15 Categories are mapped to the front-panel buttons.

Name

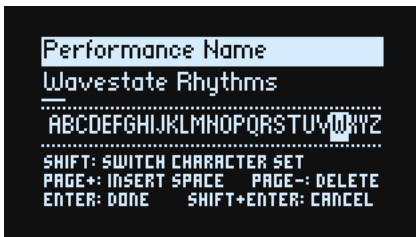

Note: you can name Programs, Wave Sequences, and Lanes without writing them separately. As long as you save the enclosing Performance, the new name will be saved.

Editing names

1. On the Write page, select the Name.
2. Press **ENTER**, or turn the **VALUE** dial.

The Name page appears.

3. Use the cursor buttons to move back and forth in the text, and use **VALUE** to select a character from the set shown below.

Names can be up to 24 characters long.

4. Press **SHIFT** to toggle between A-Z, a-z, numbers, and symbols.
5. Hold **SHIFT** and press > (**PAGE+**) to insert a space.
6. Hold **SHIFT** and press < (**PAGE-**) to delete the previous character.
7. When you've finished entering text, press **ENTER** to return to the previous page, or **SHIFT-ENTER** to cancel.

Compare

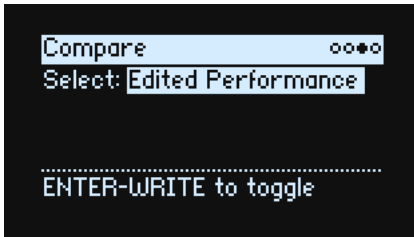

Select

[Saved Performance, Edited Performance]

Saved Performance: The saved version of the Performance will be heard.

Edited Performance: The edited version of the Performance will be heard. If the Performance has not been edited, this is not available.

Using Compare

To use compare:

1. Hold **ENTER** and press **WRITE**.

The Compare page will appear.

2. Hold **ENTER** and press **WRITE**, again, to toggle between the saved and edited versions of the Performance.

When you change from *Edited Performance* to *Saved Performance*, the edited version is stored in a buffer, and the Performance reverts to the version saved in the database. You can toggle back and forth between the two as many times as you like.

- ⚠ If you change to *Saved Performance* and then make any edits, the next time you go to the Compare page **Select** will be set to *Edited Performance*, and the previously buffered “Edited Performance” will be lost.

Delete from Database

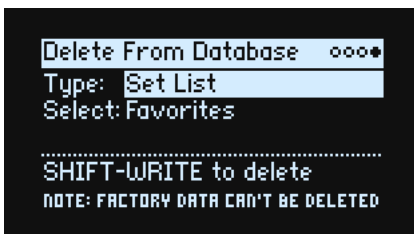

This page lets you delete user-created items from the database.

- ⚠ **Note:** Factory data cannot be deleted.

Using Delete

To delete an item from the database:

1. Set the Type as desired.
 2. Cursor to Select, and press **ENTER**.
- The selection popup appears.
3. Select a user-created item from the list. Optionally, use **PAGE+** to change the filters or sort order.
 4. Press **ENTER** to confirm the selection and close the popup.
 5. Hold **SHIFT** and press **WRITE** to delete the selected item.

A confirmation dialog will appear.

6. Press **ENTER** to confirm, or **SHIFT-ENTER** to cancel.

Wave Sequencing 2.0

Overview

Wave Sequencing 2.0 is a dynamic system. Instead of each step being a matched set of sample, pitch, duration, etc., the different parameters are separated into “lanes.” Each lane can have a different number of steps, and its own start, end, loop start, and loop end.

These points (and other parameters in the lanes and their steps) can in turn be modulated on a per-note basis, using velocity, LFOs, envelopes, etc. Each time the sequence moves forward, values from the individual lanes are combined to create the output. The result can be either ever-changing rhythmic patterns or smooth, organic, crossfading timbres. Individual, modulatable step probabilities provide additional variation.

Wave Sequencing 2.0

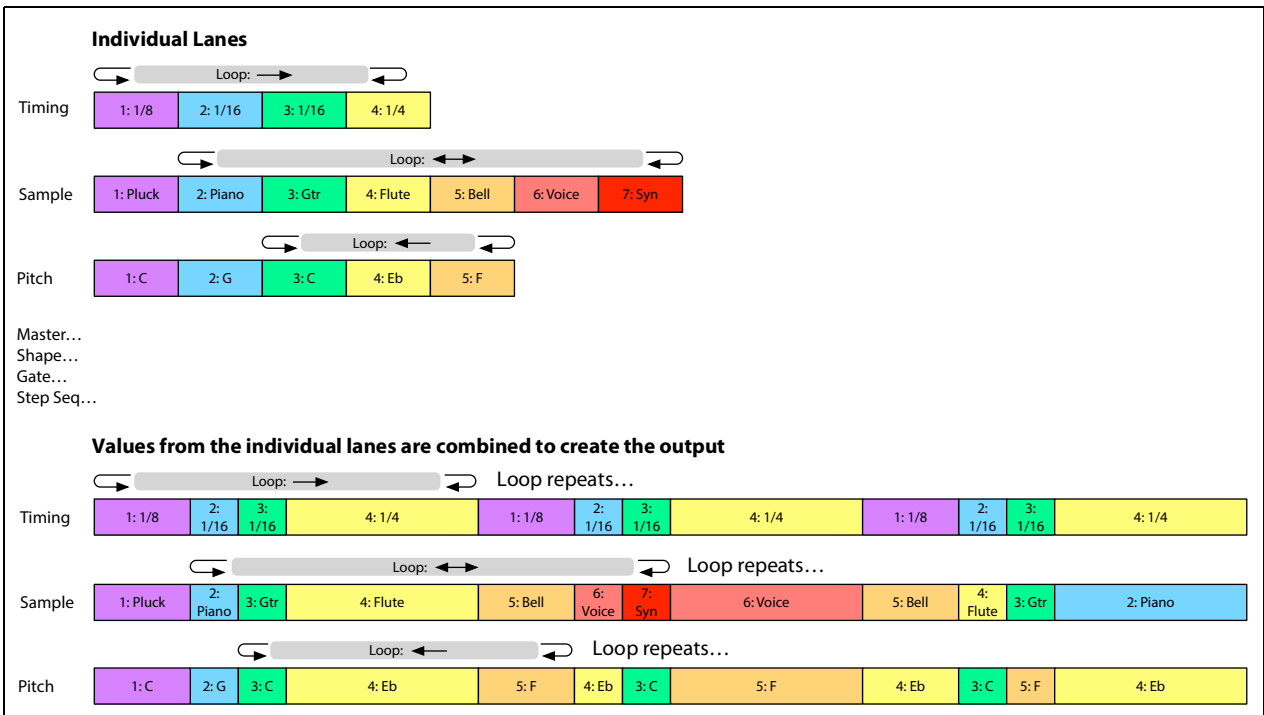

Wave Sequence editing

Editing Lanes

The Lane controls which of its Steps are played, and how they loop. Changing just the **LOOP START** or **LOOP END**, for instance, may significantly change the character of the sound. Just press the button for the desired Lane (e.g. **SAMPLE**) and use the front-panel controls; see “Front-Panel Lane Controls” on page 24. If you’re on the home page, press **LANE PRESET** to show the Lane on the display. Some Lanes have special parameters in addition to the standard controls, as described in the following sections.

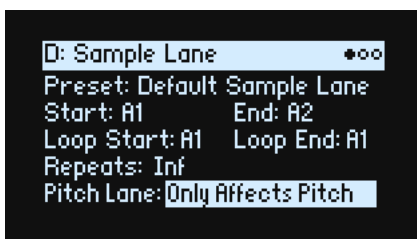

Editing Steps

There are up to 64 Steps per Lane, in four banks: A1-A16, B1-B16, etc. To view and edit individual Steps:

1. Select the desired Lane by pressing its button.
2. Press the **WSEQ STEPS** button, so that it is lit.

The 16 buttons at the bottom of the panel now select Steps.

3. To select Steps in the current bank, press buttons 1-16.

or:

To select from a different bank, double-press A/B/C/D (1/2/3/4). Alternatively, hold either **SHIFT** or **WSEQ STEPS** and then press A/B/C/D. Buttons 1-16 will then blink; press one to select a Step in the new bank.



As you select different steps, the current parameter remains the same. For instance, if you are editing the Pitch for a number of steps, you can quickly select Steps in succession, editing the Pitch via the value knob.

4. Edit as desired using the onscreen controls (cursor and **VALUE** knob).

Step Solo mode

Step solo mode makes the Lane temporarily loop on the selected Step, for auditioning samples or shapes, troubleshooting, etc.

To enter Step Solo mode:

1. Hold **ENTER** and press a Step button.

Both the Step button and the current Lane's button will blink.

The Wave Sequence will play as if that Lane was set to loop on the selected Step. Other Lanes will continue to play normally. If you select other Steps in the current Lane, solo will follow the selected Step.

To exit Step Solo mode, hold **ENTER** and press any Step button, or the current Lane's button.

Only one Lane at a time can be in Step Solo mode. If you enter Step Solo mode for a second Lane, the first Lane's Step Solo mode is turned off automatically. Changing to a different Layer also turns off Step Solo mode.

Wave Sequence

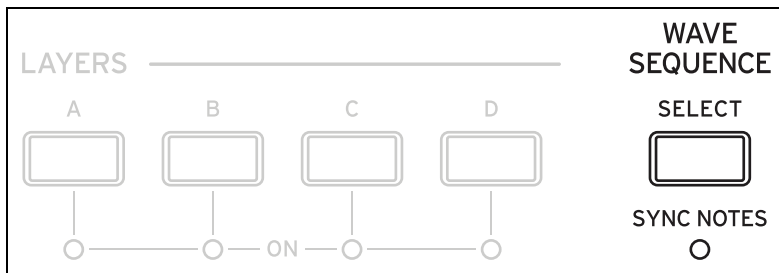

This page lets you choose a Wave Sequence or single Multisample for the Program.

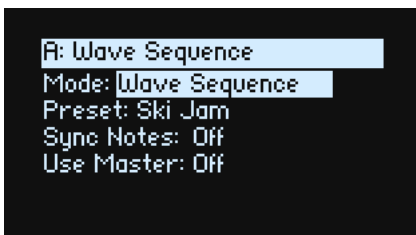

Mode

[Wave Sequence, Single Multisample]

Wave Sequence: The Program will use a Wave Sequence.

Single Multisample: The Program will use a Multisample instead of a Wave Sequence. All of the Lane controls will be disabled.

Mode = Wave Sequence

Preset

[List of Presets]

Sync Notes (SYNC NOTES)

[Off, On]

Sync Notes sets whether individual Wave Sequences play on their own separate timelines, or whether they are sync'd together.

Off: Each of the Program's Wave Sequences will play independently.

On: If at least one note of the Program is already playing, the Wave Sequence lanes for newly played notes will start on the same steps as those of the oldest note. See the graphic below. There may still be variations due to per-note modulation or Probability.

Additionally, for all Layers which have both **SYNC NOTES** and **TEMPO** turned *On*, their Wave Sequences will sync together.

Sync Notes

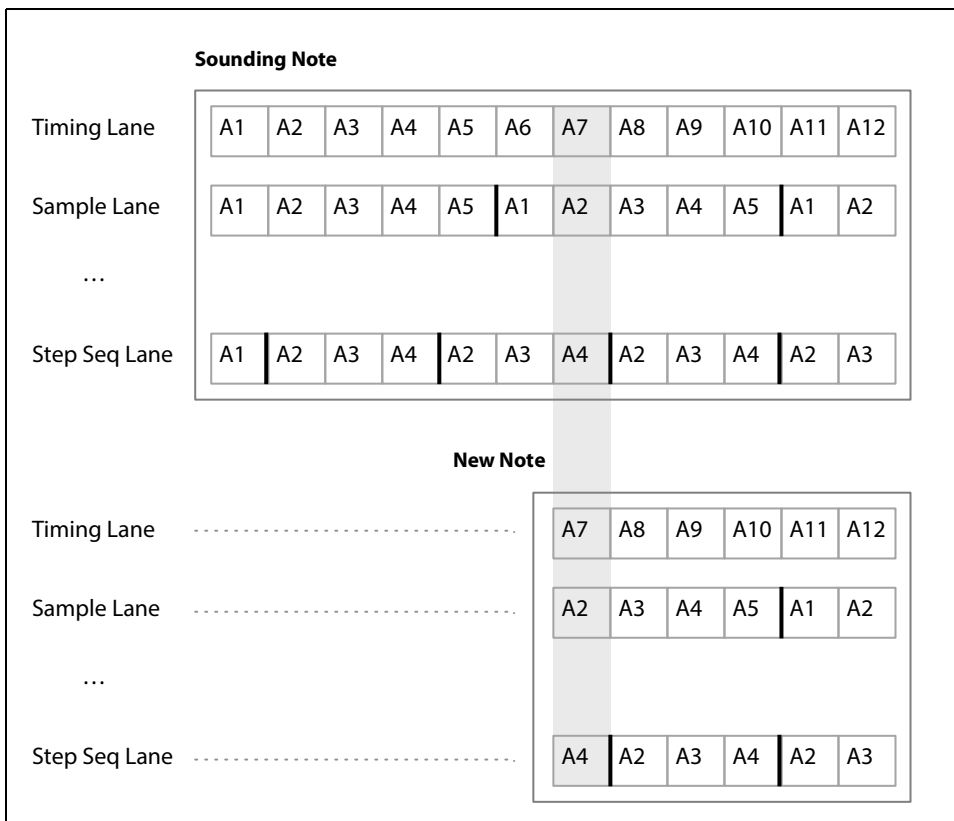

Use Master (SHIFT-MASTER)

[Off, On]

This enables the Master Lane. The parameter is stored in the Wave Sequence, as opposed to the Lane.

Mode = Single Multisample

MS (Multisample)

[List of Multisamples]

Select this parameter and then either move **VALUE** or press **ENTER** to bring up the Multisample Select popup.

Channel

See “Chan (Channel)” on page 28.

Start Offset

See “S. Offset (Start Offset)” on page 29.

Master Lane



When **Use Master** is *On*, the Master Lane restarts all of the other Lanes after either a specified number of beats or elapsed time, depending on **TEMPO** On/Off (below). Unlike other Lanes, Master has no steps, so most of the front-panel Lane controls don't apply.

Use Master (SHIFT-MASTER)

[Off, On]

See “Use Master (SHIFT-MASTER)” on page 22.

Loop Duration

[TEMPO Off: 0.0013...120.0000 seconds]

[TEMPO On: 32nd-note triplet...2x breve]

If Timing Lane **Tempo** is *Off*, you can set the length of the Master Lane loop in seconds.

If Timing Lane **Tempo** is *On*, this sets the basic length of the Master Lane, relative to the system tempo.

x (Multiply Base Note by...)

[1...32]

This appears only if **Tempo** is *On*. It multiplies the length of the **Base Note**. For instance, if the **Base Note** is set to a whole note, and **Times** is set to 3, the Master Lane will reset every three whole notes.

Front-Panel Lane Controls

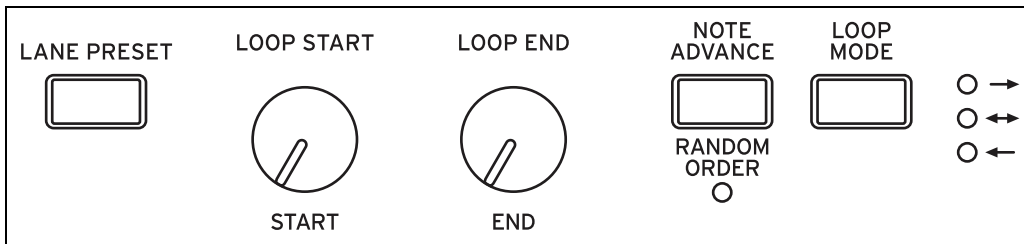

These controls apply to all lanes except Master. (Master still has Presets, however.)

LANE PRESET

Pressing this button jumps to the Preset parameter for the current Lane. Lane Presets store all of the parameters for the Lane and its Steps. Explore the system by mixing and matching presets for different Lanes.

START, END, LOOP START, LOOP END

These knobs control the Steps on which the Lane begins, ends, and loops. You can change them in real-time, while notes are sounding—and also modulate them via LFOs, Envelopes, etc. The **Loop End** must be less than or equal to the **End** step.

Repeats

[Off, 1...100, Inf]

This parameter appears on-screen only. It controls the number of times that the Lane will loop before resting on the **End Step**. The default is *Inf*, which causes the loop to repeat as long as the note is held.

LOOP MODE

This controls the direction of the loop: Forward, Backward, or alternating Forward-Backward.

NOTE ADVANCE

When this is *On*, each note played will increment the Start Step by one. Try using this with the Arpeggiator!

RANDOM ORDER (SHIFT-NOTE ADVANCE)

When this is *On*, the Steps will play in a different order every time the loop repeats.

To understand how **Random Order** works, imagine that each Step is on a note-card. Each time the loop plays, or whenever the Start Step or End Step changes, the note-cards from the **Start Step** through the **End Step** are shuffled and assigned to new numbers (A1, A2, etc.). If there are any Steps before the **Start** they are not included in the shuffle; instead, they stay in place and retain their original values, even if they will play due to loop settings. Steps after the End Step are ignored. For playback purposes, the Start, End, Loop Start, and Loop End all work on the newly assigned numbers. Unlike changing the **Start Step** or **End Step**, changing the **Loop Start Step** or **Loop End Step** does not cause re-shuffling.

Step Probability

Each individual Step has a **Probability** setting, from 0% to 100%. This controls how likely the Step is to play. As with most Step parameters, **Probability** can be modulated; for instance, moving a Mod Knob might make some Steps more likely to occur, and other steps less likely to occur.

If a step has less than 100% **Probability** and loses the roll of the dice, as it were, it is skipped. (See note about the Timing Lane, below.) Since the Wave Sequence is generated in real-time, we need to avoid a situation in which we repeatedly roll the dice, lose the throw, and roll again and again; eventually, we need to make some sound! So, if two steps in a row are skipped, the third step always is played—even if its probability is 0%.

Timing Lane probability

The Timing Lane works slightly differently regarding probability: “skipped” steps are absorbed into the previous step. For instance, if A1 and A2 are both 16th notes, and A2 is skipped due to probability, A1 becomes an 8th note. This maintains the overall length of the rhythm.

Timing

This Lane controls the duration and crossfade of each Step, creating rhythms or smooth, evolving sounds.

Timing Lane

Tempo Off

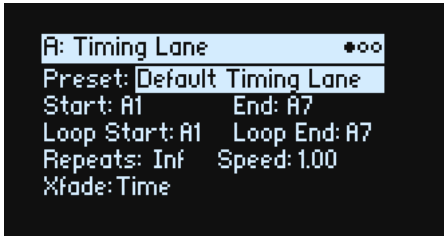

Tempo On

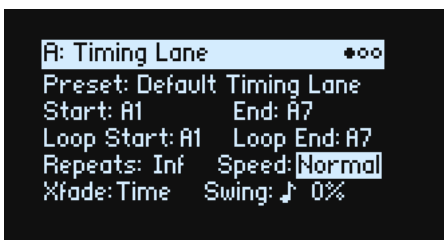

Preset, Start, End, Loop Start, Loop End, Repeats

See “Front-Panel Lane Controls” on page 24.

TEMPO (SHIFT-TIMING)

[Off, On]

Durations can use either time (**TEMPO Off**) or rhythmic values (**TEMPO On**).

Speed

[TEMPO Off: 0.01...100.00]

[TEMPO On: 1/4...4x]

This modifies the speed of the entire Timing Lane. When **TEMPO** is *Off*, you can vary this continually from *0.01* (1/100 of the original speed) to *100.00* (100 times the original speed). Try modulating this from the **SPEED** knob, or from an envelope!

When **TEMPO** is *On*, you can select tempo-locked ratios from *1/4* to *4x* of the original speed.

Xfade

[Time, Tempo, Off]

This determines how all of the Step **Xfade** parameters will work.

Time: Crossfade times are set in seconds.

Tempo: Crossfade times are set in rhythmic values.

Off: All transitions will be abrupt, and none of the **Xfade**-related parameters will apply.

Swing (Resolution)

[32nd-note triplet...quarter-note]

(Swing Amount)

[-300...+300%]

Swing adjusts the timing of up-beats relative to the Swing Resolution. For instance, if Resolution is set to *1/8*, Swing affects every other 8th note.

+100%: Full “swing.” Up-beats become triplets, moving one third of the way toward the next down-beat.

+300%: Up-beats move all the way to the next down-beat.

Wave Sequencing 2.0

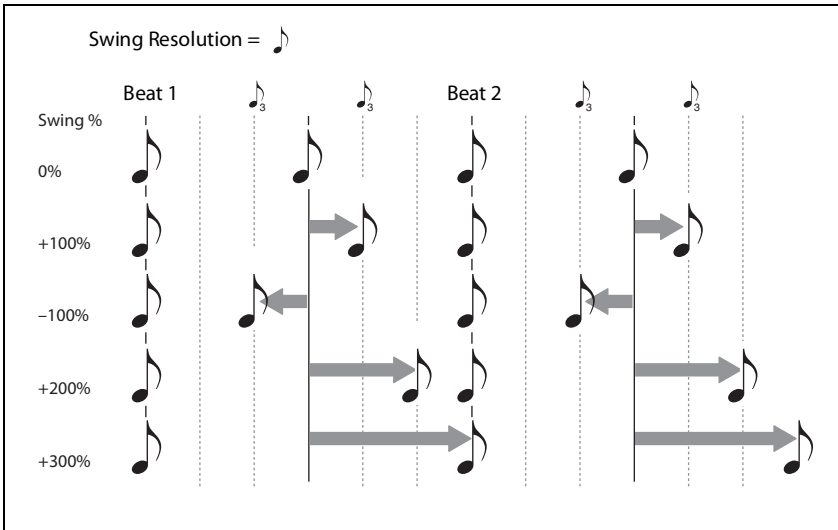

Timing Lane Step

Tempo Off



Tempo On



Step

[A1...D16]

This is the current Step. You can edit this parameter on-screen, or use the **WSEQ STEP** buttons to select Steps directly.

Type

[Note, Rest, Gate]

Note: The step will play normally.

Rest: The step will be silent.

Gate: The sequence will pause at the step until note-off, after which the sequence continues. If this is also the End Step, the Wave Sequence will stay on the step through note-off. By setting a single Timing Step to *Gate*, and then modulating the Sample Lane Start Step by velocity, you can create a sound with up to 64 velocity switches. For instance, you can use this to switch between a large number of different attack transients.

Duration

[TEMPO Off: 0.0000...10.0000 seconds]

[TEMPO On: List of rhythmic values]

If **TEMPO** is *Off*, you can set the length of the step in seconds.

Wave Sequencing 2.0

If **TEMPO** is *On*, you can set the basic length of the step as a rhythmic value, relative to the system tempo. The values range from a 32nd note to a double breve (four whole notes), including dotted notes and triplets. This length is then modified by **x (Multiply Base Note by...)**, below.

x (Multiply Base Note by...)

[1...32]

This appears only if **TEMPO** is *On*. It multiplies the length of the **Duration Base Note**. For instance, if the **Base Note** is set to an eighth note, and **Times** is set to 3, the step will last for a dotted quarter-note.

Probability

See “Step Probability” on page 24.

Xfade (Crossfade) general notes

The Xfade (crossfade) determines the time it takes to fade into the *next* step. For example, Step 1’s Crossfade determines the time to fade between Step 1 and Step 2. In general, the Xfade time cannot exceed twice the duration of the shorter of the two steps. The Fade-In and Out parameters, below, allow linear, equal-power, and custom crossfades. Crossfades times can be set in either seconds or rhythmic values, depending on whether Timing Lane **Xfade** is set to *Time* or *Tempo*. If Timing Lane **Xfade** is set to *Off*, all transitions will be abrupt and none of the **Xfade**-related parameters will appear.

Xfade

[Time: 0.0000... 10.0000 seconds]

[Tempo: List of rhythmic values]

If Timing Lane **Xfade** is set to *Time*, you can set the length of the crossfade in seconds.

If Timing Lane **Xfade** is set to *Tempo*, you can set the basic length of the crossfade as a rhythmic value, relative to the system tempo. The values range from a 32nd note to a double breve (four whole notes), including dotted notes and triplets.

x (Multiply Base Note by...)

[1...32]

This appears if Timing Lane **Xfade** is set to *Tempo*. It multiplies the length of the **Xfade Base Note**.

Fade-In (Shape)

[Log, -99...-1, Linear, +1...+99, Exp]

This sets the shape for the next step’s fade-in within the crossfade.

Log: the step will fade in quickly at first, and then move more slowly as it nears the end of the crossfade. To create an equal-power crossfade, use *Log* for both **Fade-In** and **Out**.

Linear: the step will fade in steadily over the duration of the crossfade.

Exp: the step will fade in slowly at first, and then move more rapidly as it nears end of the crossfade.

Out (Fade-Out Shape)

[Log, -99...-1, Linear, +1...+99, Exp]

This sets the shape for the current step’s fade-out within the crossfade.

Log: the step will fade out slowly at first, and then move more rapidly as it approaches the end of the crossfade.

Linear: the step will fade out steadily over the duration of the crossfade.

Exp: the step will fade out quickly at first, and then move more slowly as it nears the end of the crossfade.

Sample

This Lane sets the sample played by each Step.

Sample Lane

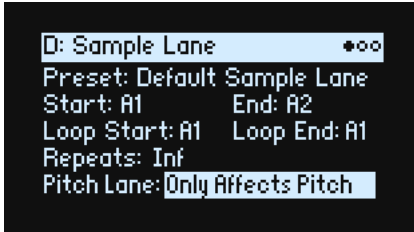

Preset, Start, End, Loop Start, Loop End, Repeats

See “Front-Panel Lane Controls” on page 24.

Pitch Lane

[Only Affects Pitch, Affects Sample Map]

Multisamples typically include many different samples, mapped across the keyboard. When you play lower and higher notes, it’s not just the pitch that changes; different samples will be selected as well. Sometimes, you may want the Pitch Lane to affect sample choice, as if you were transposing the keyboard; other times, you may want it to only change the pitch, without affecting the sample choice. This parameter lets you choose between the two options.

Only Affects Pitch: The Pitch Lane only affects the played pitch; it will not change the sample chosen by a given key.

Affects Sample Map: The Pitch Lane will act similar to transposing the keyboard, and may select different samples according to the selected Multisample.

Sample Lane Step

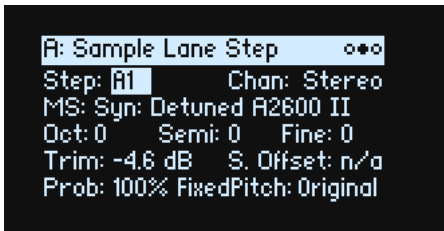

Step

See “Step” on page 26.

Chan (Channel)

[Stereo, Left, Right, n/a]

This applies to stereo Multisamples only; for mono Multisamples, “n/a” is shown. You can choose whether to use the original *Stereo* signal, or only the *Left* or *Right* channels (in mono).

MS (Multisample)

[List of Multisamples]

Select this parameter and then either move **VALUE** or press **ENTER** to bring up the Multisample Select popup.

Oct (Octave)

[-2...+2]

This transposes the Multisample up or down by up to two octaves.

Semi (Semitones)

[-12...+12]

This transposes the Multisample up or down by up to 12 semitones. Use this (and other pitch-related parameters on this page) instead of the Pitch Lane when you want the transposition to be tied to a specific Multisample.

Wave Sequencing 2.0

Fine (Fine Tune)

[-99...+99]

This tunes the Multisample up or down by up to 99 cents (1/100 of a semitone).

Trim

[-Inf, -84.9...0.0 dB]

This adjusts the volume of the Multisample.

S. Offset (Start Offset)

[Off, 1st...8th]

In addition to simply starting playback from the beginning, Multisamples may have up to 8 different pre-programmed alternate starting points, or “Start Offsets.” These skip part of the beginning of the samples, either to make them more gentle (for percussive sounds) or to make them start more quickly (for sounds with slow attacks). The number of available offsets will vary depending on the specific Multisample.

If no alternate start points are available, this will show *n/a*.

Prob (Probability)

See “Step Probability” on page 24.

Fixed Pitch

[Original, Off, On, On+Pt Lane]

By default, most Multisamples change in pitch as you play up and down the keyboard. A few, however, use “Fixed Pitch” so that they make the same sound all the way across the keyboard—such as for drums or special effects. This parameter allows you to enable Fixed Pitch for Multisamples which normally transpose, or disable Fixed Pitch for those which normally do not transpose.

 Use this for creative purposes, but be aware that Multisamples may behave strangely if this is set to anything other than Original.

Original: This is the default. Fixed Pitch will be on or off according to the Multisample’s programmed value.

Off: The Multisample will transpose. Multisamples originally programmed to use Fixed Pitch may reach their transposition limit at some point on the keyboard, and not get any higher in pitch.

On: The Multisample will use Fixed Pitch even if it is not programmed to do so. **Note:** in some cases, you may hear the individual samples in the Multisample, each at their original pitch. Also, the Pitch Lane will not affect this Step.

On+Pt Lane: Similar to *On*, except that the Pitch Lane will affect the Step.

Pitch

This Lane sets the pitch of each Step.

Pitch Lane

Presets, Start, End, Loop Start, Loop End, Repeats

See “Front-Panel Lane Controls” on page 24.

Use Shape

[Off, On]

When this is *On*, non-zero pitch values will be scaled by the Shape Lane. If the pitch offsets are zero, Shape has no effect.

Fit to Scale

[Off, On]

This lets you constrain the Pitch Lane’s output to a specific scale and key—especially useful when playing polyphonically.

Off: Pitch offsets will be played exactly as they are entered in the sequence.

On: Pitches will be constrained to the specified scale and key.

Wave Sequencing 2.0

(Scale Key)

[C...B]

This sets the root note of the scale. For instance, if Scale Key is set to E, and the Scale Type is set to Minor, all notes generated by the Pitch Lane will be confined to notes in the E Minor scale: E, F#, G, A, B, C, or D.

Scale Key only applies if **Fit To Scale** is *On*.

(Scale Type)

[Major, Minor, Hrmnic Maj, Hrmnic Min, Melodic Min, Dorian, Phrygian, Lydian, Mixolydian, Locrian, Penta Maj, Penta Min, Diminished, Half Dim, Augmented, Whole Tone, Tritone, Blues, Bebop Dom, Flamenco, Romani, Hungarian, Persian, Harmonics, Acoustic, Enigmatic]

This selects the scale to which the generated notes will be confined. It only applies if **Fit To Scale** is *On*.

Scale	Notes generated by Pitch Lane (if Scale Key = C)											
	C	C#	D	D#	E	F	F#	G	G#	A	A#	B
Major	C	C	D	E	E	F	G	G	A	A	B	B
Minor	C	C	D	D#	D#	F	G	G	G#	G#	A#	A#
HarmonicMajor	C	C	D	E	E	F	G	G	G#	G#	B	B
HarmonicMinor	C	C	D	D#	D#	F	G	G	G#	G#	B	B
MelodicMinor	C	C	D	D#	D#	F	G	G	A	A	B	B
Dorian	C	C	D	D#	D#	F	G	G	A	A	A#	A#
Phrygian	C	C#	D#	D#	F	F	G	G	G#	G#	A#	A#
Lydian	C	C	D	E	E	F#	F#	G	A	A	B	B
Mixolydian	C	C	D	E	E	F	G	G	A	A	A#	A#
Locrian	C	C#	D#	D#	F	F	F#	F#	G#	G#	A#	A#
MajorPentatonic	C	C	D	D	E	E	G	G	G	A	A	A
MinorPentatonic	C	C	D#	D#	D#	F	F	G	G	A#	A#	A#
Diminished	C	C	D	D#	D#	F	F#	F#	G#	A	A	B
HalfDiminished	C	C	D	D#	F	F	F#	F#	G#	G#	A#	A#
Augmented	C	C	D#	D#	E	E	G	G	G#	G#	B	B
WholeTone	C	C	D	E	E	F#	F#	G#	G#	A#	A#	A#
Tritone	C	C#	C#	E	E	F#	F#	G	G	A#	A#	A#
BluesScale	C	C	D#	D#	D#	F	F#	G	G	A#	A#	A#
BebopDominant	C	C	D	E	E	F	G	G	A	A	A#	B
Flamenco	C	C#	C#	E	E	F	G	G	G#	G#	B	B
Romani	C	C	D	D#	D#	F#	F#	G	G#	G#	A#	A#
HungarianMinor	C	C	D	D#	D#	F#	F#	G	G#	G#	B	B
Persian	C	C#	C#	E	E	F	F#	F#	G#	G#	B	B
Harmonics	C	C	D#	D#	E	F	G	G	G	A	A	A
Acoustic	C	C	D	E	E	F#	F#	G	A	A	A#	A#
Enigmatic	C	C#	C#	E	E	F#	F#	G#	G#	A#	B	B

Pitch Lane Step

Step

See "Step" on page 26.

Transpose

[-24...+24 semitones]

This offsets the played note by up to two octaves, up or down. This also affects the index into the Multisample map, potentially changing the sample selection, similar to transposing the entire keyboard.

Tune

[-12.00...+12.00 semitones]

This changes the tuning by up to one octave up or down. It does not affect the Multisample map.

Probability

See “Step Probability” on page 24.

Shape

The Shape Lane creates a contour over the duration of the step. It can affect volume (when **Shape Controls Volume** is *On*) and/or the Pitch or Step Sequencer Lanes (when the respective Lane’s **Use Shape** is *On*).

Shape Lane

Presets, Start, End, Loop Start, Loop End, Repeats

See “Front-Panel Lane Controls” on page 24.

Shape Controls Volume

[Off, On]

Off: Shape does not affect the Wave Sequence volume.

On: Shape directly controls the Wave Sequence volume.

Shape Lane Step

Step

See “Step” on page 26.

Shape

[List of shapes]

There are a large number of shapes to choose from, including ones with two, three, or four pulses.

Offset

[-1.00...+1.00]

This shifts the entire shape up or down. It works slightly differently from Mod Processor “Offset,” in that the **Offset** is added to the shape, and then the result is scaled by the **Level**, below. For instance, if you want Shape to control volume, but don’t want the volume to drop all the way to silence, set **Offset** to *+1.00* and **Level** to *+0.50*.

Level

[-2.00...+2.00]

This varies the amplitude of the Shape. Negative values invert the shape.

Phase

[-180...+180°]

This controls the start point of the shape. For example, to start in the middle of the shape, set the Phase to *+180°*.

Prob (Probability)

See “Step Probability” on page 24.

Gate

[Truncate, Scale Shape]

Scale Shape: the shape is scaled in time by the **Gate Length** (as well as the Timing Step **Duration**). For example, if **Gate Length** is 50%, the “ADSR” shapes will play twice as fast. Use this to create more variation in the generated shapes.

Truncate: the shape is scaled in time only by the Timing Step **Duration**. If **Gate Length** is less than 100%, the end of the shape is truncated.

Gate

This controls how long the Step sounds, as a percentage of the duration from the Timing Lane.

Gate Lane

Presets, Start, End, Loop Start, Loop End, Repeats

See “Front-Panel Lane Controls” on page 24.

Gate Lane Step

Step

See “Step” on page 26.

Gate Length

[0...100%]

This controls the length of time that the step will sound, as a percentage of the Timing Lane Step **Duration**.

Probability

[0...100%]

See “Step Probability” on page 24.

Step Seq

This Lane generates a modulation source to control other synthesis parameters, just like envelopes, LFOs, etc.

Important: Wave Sequences run independently per voice. This means that the Step Seq Lane can only modulate per-voice parameters, such as settings in the Amp, Pitch, Filter, Envelopes, and LFOs. Specifically, the Step Seq Lane cannot modulate the Mod Knobs, effects, or Vector Envelope.

Step Seq Lane

Presets, Start, End, Loop Start, Loop End, Repeats

See “Front-Panel Lane Controls” on page 24.

Use Shape

[Off, On]

When this is *On*, non-zero values will be scaled by the Shape Lane.

Step Seq Lane Step

Step

[A1...D16]

See “Step” on page 26.

Type

[**Value + Continuous Mod**, **Value * Random +/-**, **Value * Random +**, **Value + S & H Mod**]

Value + Continuous Mod: The Step uses the programmed value, and modulation continuously affects the value. For instance, if an LFO is modulating **Value**, you’ll hear the LFO’s shape during the step.

Value * Random +/-: The Step’s **Value** is scaled by a bipolar random amount. The result may be either positive or negative.

Value * Random +: The Step’s **Value** is scaled by a unipolar random amount. If the **Value** is positive, the output will be positive; if the **Value** is negative, the output will be negative.

Value + S & H Mod: The Step uses the programmed value, and modulation is updated only at the start of the Step. For instance, if an LFO is modulating **Value**, only the LFO’s amplitude at the very start of the step matters; you will *not* hear the LFO’s shape during the step.

Value

[-100...100%]

This sets the output level for the Step.

Probability

See “Step Probability” on page 24.

Wave Sequence Utility

Cut Steps, Copy Steps, Paste Steps, Insert Steps, Add Steps To End

To cut, copy, paste, insert, or add Steps to either a single Lane or all Lanes:

1. From a Wave Sequence Lane page, use **PAGE+** to go to the Lane Utility page.
2. Select an Action such as Cut Steps or Add Steps To End.
3. Set the Scope as desired, to apply the Action to all Lanes or to only the current Lane.
4. Set the other parameters (From Step, Through, etc.) as desired.
5. Press **ENTER** to execute the command.

Scale Timing

This Action is available only when entering the Wave Sequence Utility page via the Timing Lane. It allows you to edit all of the Timing Lane Step Durations at once, to make the sequence longer or shorter. If you want to change this in real-time, use the Timing Lane **Speed** parameter instead.

Vector

Overview

Vector Synthesis lets you control the sound by moving the Vector Joystick, using the programmable Vector Envelope, or the combination of the two.

What does Vector mean?

Modulation generally works by moving a single control, like a slider, in a straight line. At one end of the control, the modulation is at its minimum; at the other end, it's at its maximum.

Vector Synthesis is a little different. It works by moving around a point on a two-dimensional plane, both left-right and up-down.

You can think of this point as being positioned on two different lines at once: a left-right line (the X axis), and an up-down line (the Y axis).

In other words, instead of just having one value (like a slider), each Vector point has two values: one for X, and one for Y. See the graphic below for an example.

Vector Point and X and Y axis values

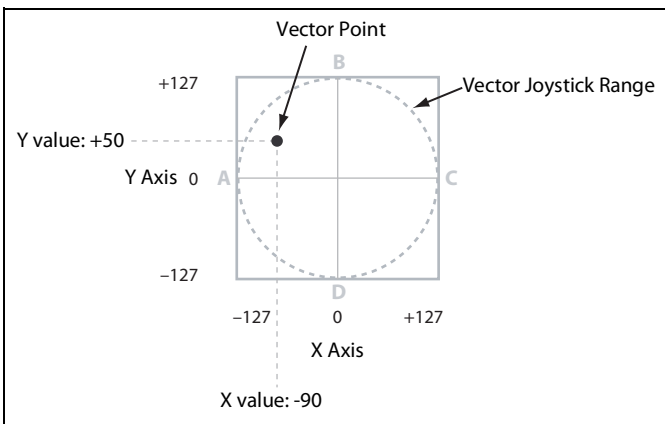

In addition to moving the point directly with the Vector Joystick, you can also use the Vector Envelope to move its position automatically over time, as shown below.

Vector Envelope moving the Vector Point

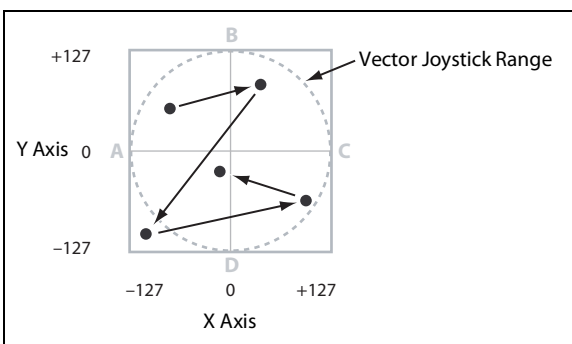

Vector Joystick and Vector Envelope

You can move the Vector point using the combination of the Vector Joystick and the Vector Envelope. The two work together, although you don't have to use both at the same time.

When the Vector Joystick is in its center position, the Vector Envelope has complete control over the point's position. Likewise, when the Vector Envelope is in the center, the Vector Joystick has complete control.

Vector

When the Vector Envelope is in use, the Vector Joystick offsets the Vector Envelope position by up to halfway across either axis. For instance, if the Envelope is all the way to the right of the X axis, and the Joystick is all the way to the left, the actual Vector position will be in the center of the X axis.

Vector Volume Control and modulation

Vector does several things:

- It generates four per-voice modulation signals, Vector Env A/B/C/D
- It generates similar modulation signals at the Performance level, shared by all voices, for modulation of things like effects and the Performance Mod Knobs
- When **Vector Volume** is *On*, it also controls the relative volumes of Layers A-D on a per-voice basis

You can also use the Vector Joystick's X- and Y-axes as modulation sources, independent from the Vector Envelope. Since the Vector Envelope's settings are stored in the Performance, it's best used for Performance-specific purposes, such as changing parameters (e.g. filter cutoff) in conjunction with volume, or interactions between layers.

Vector and MIDI

The Vector Joystick sends and receives two MIDI controllers: CC #16 is the X axis, and CC #17 is the Y axis.

Vector Env Volume

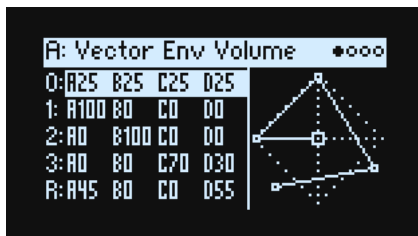

The Vector Envelope has five points: 0, 1, 2, 3 (Loop), and Release. Each point has X and Y positions, from which the A, B, C, and D percentages are derived.

This page shows the A/B/C/D volume values for each point as percentages of full volume. For a given point, A, B, C, and D will always add up to 100; positions outside the diamond are clipped. To change the values, cursor to a point and then move the Vector Joystick. (Note: this requires that the Vector Env Setup page's **Joystick Edit** is *On*).

The Vector Env Volume and Vector Env X-Y pages show the same set of position values from different perspectives. You can edit the values on either page.

Vector Env X-Y

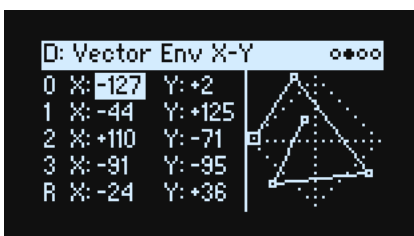

This page shows the X-Y coordinates for each point, which also translate into the Vector Env modulation outputs. You can edit these by hand if desired, or enter values into the selected point via the joystick. Unlike volumes, modulation outputs are not clipped to the diamond shape.

Note: edits from the joystick apply to both X and Y values, even though only one of the pair will be selected.

Positions, times, and **Time Scale** are modulatable from channel sources such as the Mod Wheel, MIDI CCs, and Performance Mod Knobs as well as by velocity and note number—but not from per-voice sources such as Envelopes and LFOs.

Vector

X (0...3, R)

[-127...+127]

0 is the center; -127 is far left, and +127 is far right.

Y (0...3, R)

[-127...+127]

0 is the center; -127 is bottom, and +127 is top.

Vector Env Time

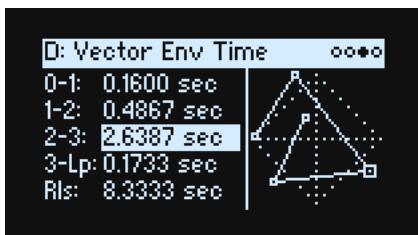

The front-panel knobs control the five Time parameters. The units are in either seconds or note values, depending on the Vector Env Setup page's **Mode** parameter.

- The first three times are the transitions from **0-1**, **1-2**, and **2-3**.
- The fourth time, **3-Lp**, is the transition from 3 to the next point in the loop, which may vary depending on loop settings.
- The fifth time, **Rls**, is the transition from the position at note-off to the release point.

Time

[0.0000...60.0000 sec]

When **Mode** is set to *Time*, you can set the segment's duration in seconds.

Beats and multiply ("x")

These parameters are shown when **Mode** is set to *Tempo*. You can set the segment's duration in beats (1/32 note to 2 breve) and a multiplier (1...32).

Vector Env Setup

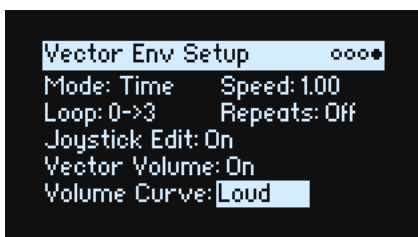

Mode

[Time, Tempo]

This selects whether the Vector Envelope segments will be specified in seconds (*Time*), or in rhythmic values (*Tempo*).

Speed

[Mode = Time: 0.01...100.00]

[Mode = Tempo: 1/4...4x]

This speeds up or slows down the envelope as a whole.

When **Mode** is set to *Time*, you can vary this continually from 0.01 (1/100 of the original speed) to 100.00 (100 times the original speed).

Vector

When **Mode** is set to *Tempo*, you can select tempo-locked ratios from $1/4$ to $4x$ of the original **Speed**.

Loop

[0->3, 1->3, 2->3, 0<->3, 1<->3]

This selects the start and end points of the loop, and whether the loop is forwards only or forwards-backwards.

0->3, 1->3, and 2->3: These loop forwards only. For instance, 1->3 makes the envelope play as follows: 0, 1, 2, 3, 1, 2, 3, 1, 2, 3 etc.

0<->3 and 1<->3: These loop forwards-backwards. For instance, 1<->3 makes the envelope play as follows: 0, 1, 2, 3, 2, 1, 2, 3 etc.

(Loop) Repeats

[Off, 1...126, Inf]

Off: The Vector Envelope proceeds to point 3, stays there until the note is released, and then proceeds to the Release point.

1-126: The Vector Envelope will loop the specified number of times, hold at point 3 until the note is released, and then proceed to the Release point.

Inf: The Vector Envelope loops as long as the note is held, and then moves to the Release point when the note is released.

Joystick Edit

[Off, On]

On: When the Vector Env Position, X-Y, or Time pages are displayed, the **VECTOR JOYSTICK** edits the position parameters instead of being a modulation source.

Off: The **VECTOR JOYSTICK** always acts as modulation source, and does not edit parameters.

Vector Volume (SHIFT-VECTOR)

[Off, On]

This enables and disables the direct control of volume by the Vector Joystick and Vector Envelope. The state is shown by the front-panel **VOL** light. When **Vector Volume** is *Off*, the Vector Joystick and Vector Envelope are still available as modulation sources.

Volume Curve

[Loud, Smooth]

This controls how Vector Volume crossfades when you move the Vector Joystick, and between points on the Vector Envelope. For maximum volume, use *Loud* (the original wavestate behavior); for more gentle crossfades, use *Smooth* (the original Wavestation behavior).

Arpeggiator

Arpeggiator



The Arpeggiator is particularly effective in conjunction with **Note Advance**, so that each generated note starts on a new step in the Lane. Try this with the Sample Lane in particular, with a single Timing step set to *Gate*.

Arpeggiator (ARPEGGIATOR)

[Off, On]

This duplicates the functionality of the front-panel **ARPEGGIATOR** button. To view this page without toggling the arpeggiator on or off, use **ENTER + ARPEGGIATOR**.

The **ARPEGGIATOR** button LED shows both **Arpeggiator On/Off** and **Performance Hold On/Off**, as shown below. (See “Performance Hold” on page 10.)

Arpeggiator button LED and Hold

	Hold Off	Hold On
Arpeggiator Off	LED Off	LED Blinks
Arpeggiator On	LED On	LED blinks: long on, short off

Latch

[Off, On]

Off: The Arpeggiator will only play as long as notes are being held on the keyboard (or via the damper pedal).

On: The Arpeggiator will continue to play after notes are released.

Pattern

[Up, Down, Alt1, Alt2, Random]

This controls the note pattern of the Arpeggiator. Most should be self-explanatory. *Alt1* and *Alt2* each go up and then down; the difference between them is that *Alt2* plays the top-most and bottom-most notes twice.

Up



Down



Arpeggiator

Alt1



Alt2

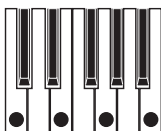

Random



Resolution

[32nd note triplet... 1/4 note]

This controls the speed of the Arpeggiator. Try modulating this from the Mod Wheel!

Swing

[-100%...+100%]

This controls the rhythmic swing of the Arpeggiator, based on the **Resolution** above.

100%: The second rhythmic division will be pushed to the third triplet, for a full swing feel.

-100%: The second rhythmic division will be pulled to the second triplet, for a reverse-swing feel.

Octaves

[1...4]

This controls the range of the arpeggiated notes. *1* uses the pitches as played. *2-4* transpose upwards by the specified number of octaves.

Gate

[0%...100%]

This sets the length of the arpeggiated notes, as a percentage of the **Resolution**.

Sync Notes

[Off, On]

Off: The arpeggiator starts immediately when the first note is played, and does not synchronize to any Wave Sequences or itself when latched. You could use this if you were playing with a human drummer and needed to reset the arpeggiator rhythm to the drummer's beat periodically.

On: The arpeggiator will synchronize to either sounding Wave Sequences or itself when latched. When synchronizing to Wave Sequences, the first note will sound when played, but subsequent arpeggiator-generated notes will be in sync with the Wave Sequence. When playing a latched arpeggiator, new notes will sound when the arpeggiator beat comes around; the arpeggiator's rhythm is not disturbed by playing new notes.

Sort

[Off, On]

Off: The Arpeggiator **Patterns** will be based on the order in which the notes were originally played. For instance, *Up* will play the notes in the originally played order, and *Down* will play the notes in reverse order.

On: The Arpeggiator plays notes according to the selected **Pattern**, sorted from lowest to highest, and ignores the originally played order.

Filter

Filter

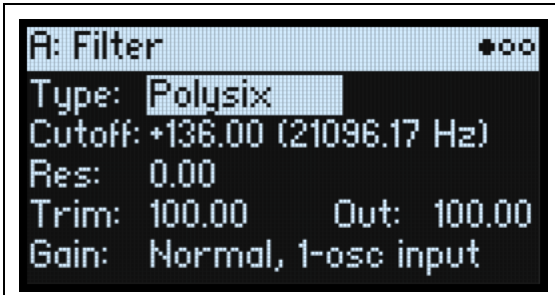

Type (FILTER TYPE)

[Polysix, MS-20 LP, MS-20 HP, 2-pole LP, 2-pole HP, 2-pole BP, 2-pole BR, 4-pole LP, 4-pole HP, 4-pole BP, 4-pole BR, Multi Filter]

Pressing the front panel **FILTER TYPE** button selects and edits the **Type** parameter. Three useful settings are available directly: the Polysix LP, the MS-20 LP, and a 2-pole resonant HP. Many more types are available by editing the on-screen parameter. If in doing so you select one of the three types listed on the front panel, the front-panel **FILTER TYPE** LEDs will update to show the selection. Selecting any other Filter Type lights the **MORE** LED. If you switch between **Types** from the front-panel button, the **MORE** position remembers the last-used “more” **Type**.

LP (Low Pass). This cuts out the parts of the sound which are **higher** than the cutoff frequency. Low Pass is the most common type of filter, and is used to make bright timbres sound darker.

HP (High Pass). This cuts out the parts of the sound which are **lower** than the cutoff frequency. You can use this to make timbres sound thinner or more buzzy.

BP (Band Pass). This cuts out all parts of the sound, both highs and lows, except for the region around the cutoff frequency. Since this filter cuts out both high and low frequencies, its effect can change dramatically depending on the cutoff setting and the oscillator’s multisample.

With low resonance settings, you can use the Band Pass filter to create telephone or vintage phonograph sounds. With higher resonance settings, it can create buzzy or nasal timbres.

BR (Band Reject). This filter type—also called a notch filter—cuts only the parts of the sound directly around the cutoff frequency. Try modulating the cutoff with an LFO to create phaser-like effects.

2-pole LP, HP, BP, and BR: These produce 12dB/octave slopes for LP and HP, and 6dB/octave for BP and BR. A classic synthesizer expander module used this type of filter.

4-pole LP, HP, BP, and BR: These produce 24dB/octave slopes for LFP and HP, and 12dB/octave for BP and BR. In comparison to 2-pole filters, these create a sharper roll-off beyond the cutoff frequency with more delicate resonance. Many classic analog synths used this general type of filter.

Multi Filter. This is a complex filter which is capable of all of the 2-pole filter types, and many more besides. See “Multi Filter,” on page 43.

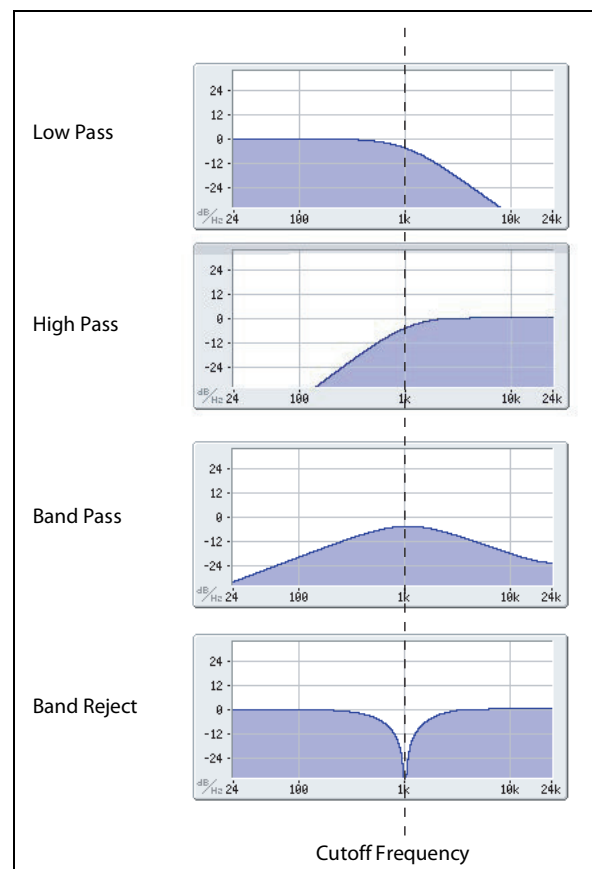

Filter

MS-20 LP and HP: These 12dB/octave, self-resonating filters lovingly recreate the distinctive timbral signature of the classic Korg MS-20. Raising **Resonance** will cause increasing amounts of saturation and overdrive, creating a more aggressive tone. Input volume can have a strong effect on this character; for more information, see “Gain” on page 42.
Polysix: This 24dB/octave, self-resonating low-pass filter provides the strong, sweet sound of the classic Korg Polysix.

Cutoff (CUTOFF)

[-4.00 or +8.00...+136.00 or +138.00 semitones]

This controls the cutoff frequency of the filter, in semitones mapped to MIDI note numbers (60.00 = middle C). The frequency in Hz is also shown. The specific effect of the cutoff frequency will change depending on the selected **Type**, as described above. Most filter types have a range of -4.00 to +138.00, but the *MS-20 LP/HP* and *Polysix* range from +8.00 to +136.00.

Res (RESONANCE)

[0.00...100.00%]

Resonance emphasizes the frequencies around the cutoff frequency, as shown in the diagram below.

When this is set to 0, there is no emphasis, and frequencies beyond the cutoff will simply diminish smoothly.

At medium settings, the resonance will alter the timbre of the filter, making it sound more nasal, or more extreme.

At very high settings, the resonance can be heard as a separate, whistling pitch.

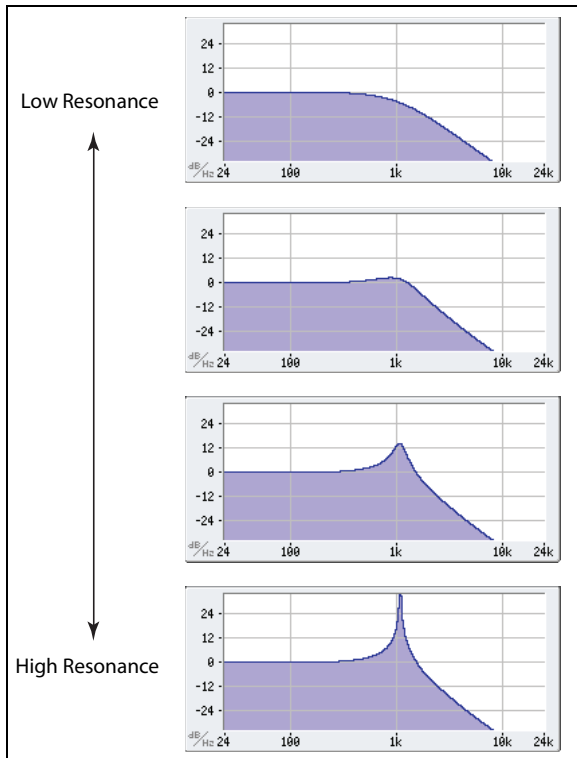

Trim

[0.00...100.00]

This adjusts the volume level at the input to the filter. If you notice that the sound is distorting, especially with high **Resonance** settings, you can turn the level down here.

Out (Output Level)

[0.00...100.00]

This controls the output level of the filter.

2-Pole LP/HP/BP/BR

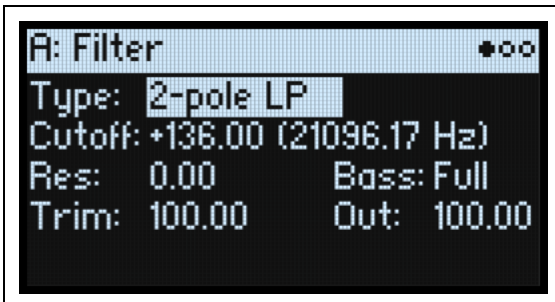

(Resonance) Bass

[Full, Tight]

This is available only when **Type** is one of the *2-pole* or *4-pole* settings, or *Multi Filter*. **Resonance Bass** controls the character of the filter resonance at low cutoff frequencies. Its effect is most noticeable with high **Resonance** settings.

Tight produces a more restrained resonance, similar to a classic, American, wood-paneled monophonic synthesizer.

Full produces a wide, boomy resonance, reminiscent of a famous five-voice American synthesizer.

4-Pole LP/HP/BP/BR

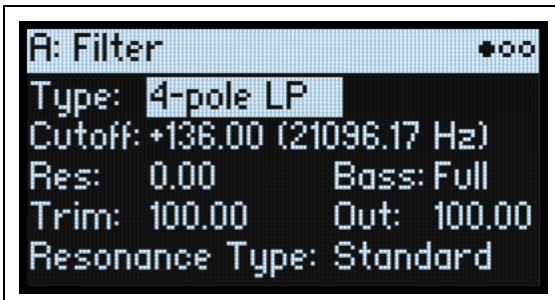

Resonance Type

[Standard, High]

This is available only when the **Type** is set to one of the *4-pole* settings.

Standard provides the resonance character of a typical analog 4-pole filter.

High creates a more pronounced resonance.

MS-20 LP/HP and Polysix

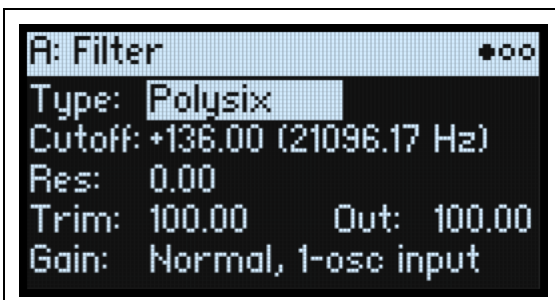

Gain

[Loud, less resonance; Unity, less resonance; Normal, 1-osc input; Normal, 2-osc input]

Gain is available only when **Type** is *MS-20 LP*, *MS-20 HP*, or *Polysix*. These filter types include saturation, which interacts with resonance. With anything other than very low resonance settings, input volume can have a strong effect on their character. The **lower** the input gain, the more headroom remains for the resonance to bloom. Use **Gain** to set the basic input level, and then fine-tune with **Trim** if desired.

Normal, 2-osc input: This is the lowest input gain. It will produce the classic resonant sounds of these filters even with extremely loud input signals.

Filter

Normal, 1-osc input: This will produce the classic resonant sounds of these filters with a single oscillator playing at full volume. When input is louder than a single full-volume oscillator, the resonance effect will be less pronounced.

Unity, less resonance: Volume is unattenuated. This leaves less headroom, so resonance will be less prominent.

Loud, less resonance: This provides a slight volume boost on input. This makes it easy to reach saturation with the input level alone, leaving very little headroom for resonance.

Multi Filter

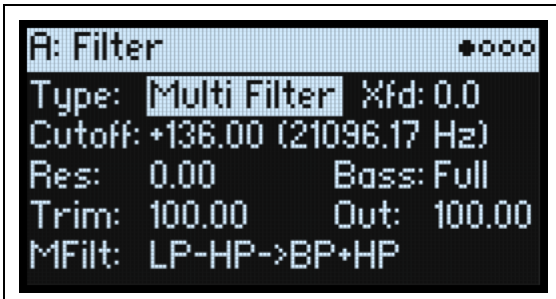

Xfd (Crossfade)

[0...100]

This is available only when **Type** is *Multi Filter*. **Crossfade** morphs between the Mode 1 and Mode 2 settings. 0 is all Mode 1, 100 is all Mode 2, and 1-99 are intermediate values between the two Modes.

MFilt (Multi Filter Preset)

[List of Presets]

This is available only when **Type** is *Multi Filter*. Presets let you quickly select from a number of useful combinations of Modes 1 and 2. You can also select any combination you wish on the Multi Filter page, described below.

Multi Filter

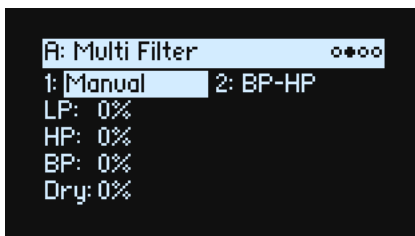

This page is available only when the Filter page **Type** is set to *Multi Filter*.

What's a Multi Filter?

Standard multimode filters generate low-pass, high-pass, and band-pass filters simultaneously—but only let you use one of them at a time. The Multi Filter gives you access to all three filter modes simultaneously, in any combination, along with the dry input signal. You can choose from a large number of preset combinations, or create your own complex filter modes using the Manual controls.

This is capable of some cool sounds in and of itself, but things really get interesting when you use **Crossfade** (see “Xfd (Crossfade)” on page 43). **Crossfade** allows you to mix between two of these filter settings (**Mode 1** and **Mode 2**), using modulation sources such as envelopes, LFOs, or real-time controllers.

1 (Mode 1)

[List of filter types]

This sets the filter type for Mode 1.

LP, *HP*, *BP*, and *BR* are the standard filter types. For more information, see “Filter,” on page 40.

Filter

LP+BP, LP-BP, LP-HP, BP+HP, BP-HP, Dry+LP, Dry-LP, Dry+BP, Dry-BP, Dry+LP-HP, Dry+LP-BP, Dry+BP-LP, Dry+BP-HP, Dry+HP-LP, Dry+HP-BP, LP+HP+BP: These combine two or more filters at equal volumes. *Dry* is the un-filtered input signal. The minus sign (“-”) indicates when the phase of a filter is reversed.

All On uses the Low Pass, High Pass, Band Pass, and Dry signals at equal volumes.

Manual lets you create your own mix of the filters; an additional four parameters will appear. For more information, see “Manual,” below.

2 (Mode 2)

Mode 2 has the same selections as Mode 1.

Manual

When Mode is set to *Manual*, these parameters let you create your own mix of the filters.

You may wonder why Band Reject is not included here. This is because it’s not a filter mode per se. Instead, it’s created by equal amounts of High Pass and Low Pass. Try it and see!

LP (Lowpass), HP (Highpass), BP (Bandpass), Dry

[-100%...+100%]

These set the volume of the Lowpass, Highpass, Bandpass, and Dry signals, respectively. Negative values invert the phase.

Filter Mod

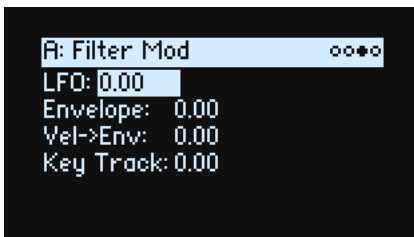

These four parameters control the default modulation routings for Filter Cutoff. You can create additional routings as desired; for more information, see “Adding Modulation Routings” on page 54.

LFO (INTENSITY)

[-142.00...+142.00]

This sets the amount of modulation from the Filter LFO, in semitones.

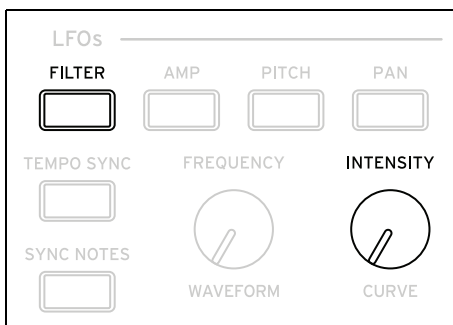

Envelope (ENV INTENSITY)

[-142.00...+142.00]

This sets the amount of modulation from the Filter Envelope, in semitones.

Vel->Env (VELOCITY)

[-142.00...+142.00]

This lets you use velocity to scale the amount of the Filter Envelope applied to Filter Freq, in semitones.

Filter

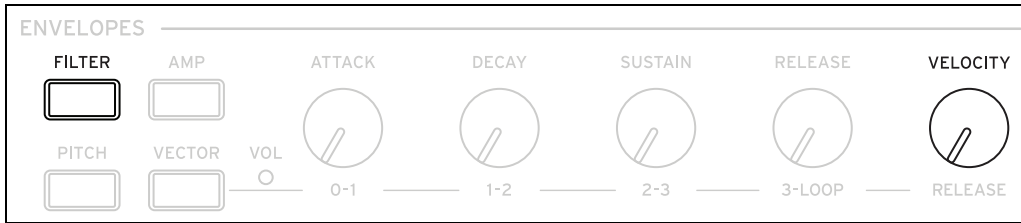

Key Track (SHIFT-CUTOFF)

[-142.00...+142.00]

This controls how much the Key Track will affect the Cutoff frequency. The value is the amount, in semitones, that the filter will change over five octaves of keyboard with a standard -1.00/+1.00 slope. The overall effect of the Keyboard Track is a combination of this value and the Keyboard Track shape.

With positive values (+), the effect will be in the direction specified by keyboard tracking; if the Slope goes up, the Cutoff will *increase*.

With negative values (-), the effect will be in the opposite direction; if the Slope goes up, the Cutoff will *decrease*.

To create one-octave-per-octave key tracking (useful when creating pitch through filter resonance):

1. Set the Key Track amount to **+60.00 semitones**.
2. In Filter Key Track, set Low and Low-Mid Slopes to **-1.00**, and Mid-High and High Slopes to **+1.00**.

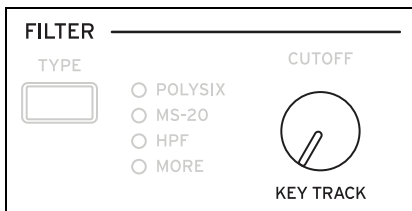

Filter Key Track



Keyboard Track

Most acoustic instruments get brighter as you play higher pitches. At its most basic, keyboard tracking re-creates this effect by increasing the cutoff frequency of a lowpass filter as you play higher on the keyboard. Usually, some amount of key tracking is necessary in order to make the timbre consistent across the entire range.

The wavestate keyboard tracking can also be much more complex, since it allows you to create different rates of change over up to four different parts of the keyboard. For instance, you can:

- Make the filter cutoff increase very quickly over the middle of the keyboard, and then open more slowly—or not at all—in the higher octaves.
- Make the cutoff increase as you play *lower* on the keyboard.
- Create abrupt changes at certain keys, for split-like effects.

How Key Track works: Keys and Slopes

The keyboard tracking works by creating four ramps, or slopes, between five keys on the keyboard. The bottom and top keys are fixed at the bottom and top of the MIDI range, respectively. You can set the other three keys—named **Low**, **Mid**, and **High**—to be anywhere in between.

The four Slope values control the rate of change between each pair of keys. For instance, if the **Low-Mid Slope** is set to 0, the value will stay the same between the **Low Key** and the **Mid Key**.

You can think of the resulting shape as being like two folding doors attached to a hinge in the center. At the **Mid Key** (the main hinge), the keyboard tracking has no effect. The two folding doors swing out from this center point to create changes in the higher and lower ranges of the keyboard.

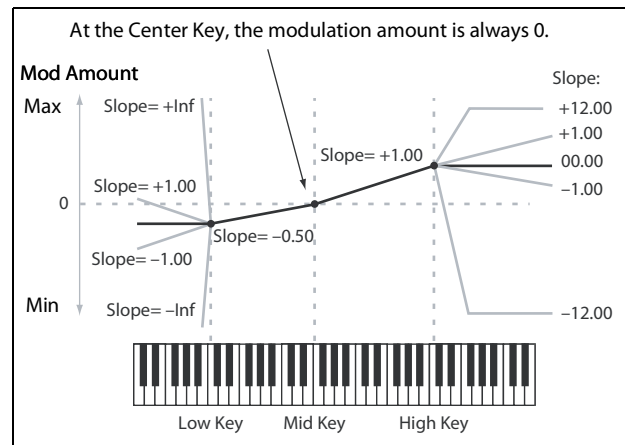

Slope

Positive slope values mean that the keyboard tracking output increases as you play farther from the Mid Key; negative slope values mean that it decreases. Because of this, the meaning of positive and negative slopes changes depending on whether the slope is to the left or right of the **Mid Key**.

Low and Low-Mid: negative slopes make the output go down as you play **lower** on the keyboard, and positive slopes make the output go up.

Mid-High and High: negative slopes make the output go down as you play **higher** on the keyboard, and positive slopes make the output go up.

The table below shows how the slopes affect the modulation output:

Slope value	Modulation change
-Inf	0 to minimum in 1 half-step
-10.00	0 to minimum in 6 semitones
-5.00	0 to minimum in 1 octave
-1.00	0 to minimum in 5 octaves
0	no change
+1.00	0 to maximum in 5 octaves
+5.00	0 to maximum in 1 octave
+10.00	0 to maximum in 6 semitones
+Inf	0 to maximum in 1 half-step

The final effect of Key Track is a combination of the Key Track shape and the modulation intensity. With greater Slope values, the Key Track shape can max out fairly quickly. Because of this, if you want a more intense effect, it's best to increase the modulation intensity first, rather than increasing the Slope.

+Inf and -Inf slopes

+Inf and -Inf are special settings which create abrupt changes for split-like effects. When a slope is set to +Inf or -Inf, the keyboard tracking will go to its extreme highest or lowest value over the span of a single key.

Note: if you set the **Mid-High Slope** to +Inf or -Inf, the **High Slope** will have no effect. Similarly, if you set the **Low-Mid Slope** to +Inf or -Inf, the **Low Slope** will have no effect.

Low Slope

[-Inf, -12.00...+12.00, +Inf]

This sets the slope between the bottom of the MIDI note range and the Low key. For normal key track, use negative values. -1.00 is the default.

Filter

(Low) Key

[C-1...G9]

This sets the breakpoint note between the two lower slopes—the “hinge” of the lower door.

 The Low Key can't be set above the Mid Key.

Low-Mid Slope

[-Inf, -12.00...+12.00, +Inf]

This sets the slope between the Low and Mid keys. For normal key track, use negative values. *-1.00* is the default.

Mid Key

[C-1...G9]

This sets the center of the keyboard tracking—the main “hinge.” When this key is played, the Key Track output is 0.

 The Mid Key can't be set below the Low Key, or above the High Key.

Mid-High Slope

[-Inf, -12.00...+12.00, +Inf]

This sets the slope between the Mid and High keys. For normal key track, use positive values. *+1.00* is the default.

High Key

[C-1...G9]

This sets the breakpoint note between the two higher slopes—the “hinge” of the upper door.

 The High Key can't be set below the Mid Key.

(High) Slope

[-Inf, -12.00...+12.00, +Inf]

This sets the slope between the High key and the top of the MIDI note range. For normal key track, use positive values. *+1.00* is the default.

Pitch

Pitch

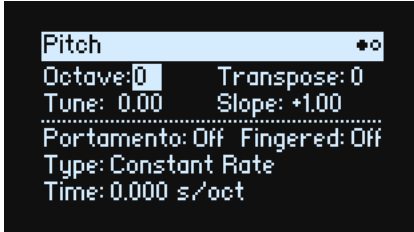

Octave (SHIFT-RESONANCE)

[-2, -1, 0, +1, +2]

This sets the basic pitch, in octaves. The default is 0.

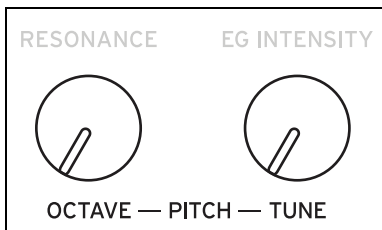

Transpose

[-12...+12]

This adjusts the pitch in semitones, over a range of ± 1 octave. This also affects the index into the Multisample map, potentially changing the sample selection, similar to transposing the entire keyboard.

Tune (SHIFT-ENV INTENSITY)

[-12.00...+12.00]

This adjusts the pitch in semitones, over a range of ± 1 octave.

Slope

[-1.0...+2.0]

This controls how pitch tracks the keyboard. Normally, it should be set to the default of +1.0.

Positive (+) values cause the pitch to rise as you play higher on the keyboard, and negative (-) values cause the pitch to *fall* as you play higher on the keyboard.

When **Slope** is 0, playing different notes on the keyboard won't change the pitch at all; it will be as if you're always playing C4.

This can be useful for special effects or percussion.

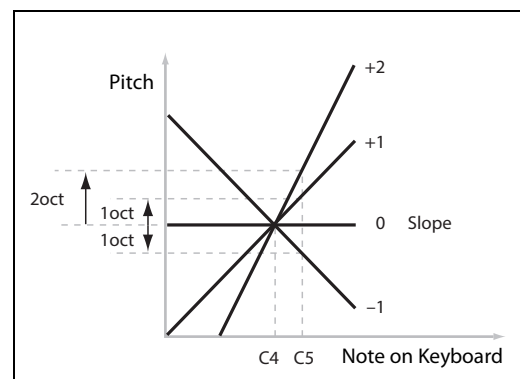

Portamento

[Off, On]

Portamento lets the pitch glide smoothly between notes, instead of changing abruptly.

On: Turns on Portamento, so that pitch glides smoothly between notes.

Off: Turns off Portamento. This is the default.

Fingered

[Off, On]

Fingered applies only when **Portamento** is *On*.

Pitch

On: Playing legato will turn on Portamento, and playing detached will turn it off again.

Off: Legato/detached playing will not affect Portamento.

Type

[Constant Rate, Constant Time]

Constant Rate: Portamento will always take the same amount of time to glide a given distance in pitch—for instance, one second per octave. Put another way, gliding several octaves will take much longer than gliding a half-step.

Constant Time: Portamento will always take the same amount of time to glide from one note to another, regardless of the difference in pitch. This is especially useful when playing chords, since it ensures that each note in the chord will end its glide at the same time.

Time

[0.000...50.000 sec or s/oct]

This controls the portamento time. If **Type** is set to *Constant Rate*, the units are s/oct (seconds per octave). If **Type** is set to *Constant Time*, the units are simply sec (seconds).

Pitch Mod

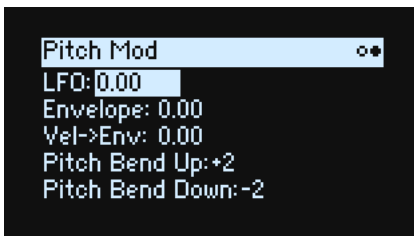

LFO (INTENSITY)

[-144.00...+144.00]

This controls the initial effect of the Pitch LFO on the pitch, in semitones.

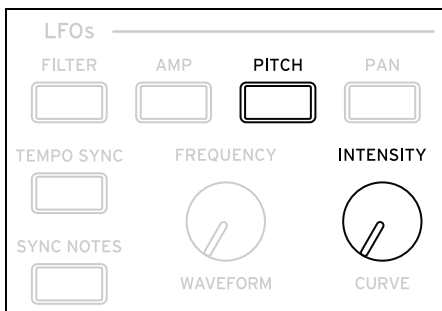

To create a vibrato effect from the Mod Wheel:

1. **Create a modulation routing with Mod Wheel as the source and Pitch LFO Intensity as the destination.**

Internally, this will actually create a routing to Pitch Tune, with the Pitch LFO as the first source and Mod Wheel as the second.

2. **Set the Intensity as desired. 1 semitone is a good starting point.**

Now, raising the Mod Wheel will introduce vibrato.

Envelope

[-144.00...+144.00]

This controls the initial effect of the Pitch Envelope, in semitones, before any modulation (such as from Velocity, below).

The Pitch Envelope Sustain Level can be either positive or negative, so the envelope can create negative values.

Pitch

Vel->Env (VELOCITY)

[-144.00...+144.00]

This lets you use velocity to scale the amount of the Pitch Envelope applied to pitch, in semitones.

Pitch Bend Up

[-60...+60]

This sets the maximum amount of pitch bend, in semitones, when you move the wheel above the center point. For normal pitch bend, set this to a positive value.

Pitch Bend Down

[-60...+60]

This sets the maximum amount of pitch bend, in semitones, when you move the wheel below the center point. For normal pitch bend, set this to a negative value.

Amp

Amp

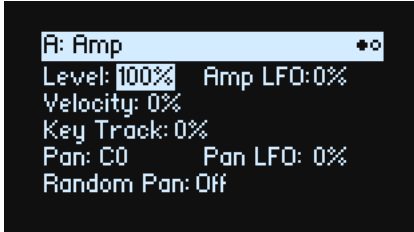

Notes on Amp Modulation

Amp modulation scales the Amp **Level** and Amp Envelope, with an upper limit of 2x the original settings to prevent uncontrollably loud output. If the original level is low, the maximum modulated volume will also be low.

(For the technically inclined: Amp modulation is multiplicative. Modulation values are offset by +1.0, so that a value of 0 has no effect. The maximum modulation value—for example, moving the Mod Wheel all the way up—doubles the volume level if the Intensity is +100%, or brings the level to silence if the Intensity is -100%.)

Tip: To start with a low level (or silence) and then use modulation to raise the level to maximum, use the Filter **Output Level** instead.

Level (LEVEL)

[0%...100%]

This sets the basic volume of the Program, optimized for per-voice modulation. For adjusting the volumes of Programs within a Performance, it's better to use the Layer **Volume** instead.

Amp LFO (INTENSITY)

[-100%...+100%]

This controls the amount of modulation from the Amp LFO.

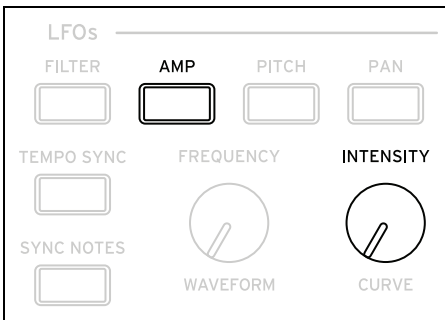

Velocity (VELOCITY)

[-100%...+100%]

This reduces volume according to velocity.

With *positive* (+) values, the volume increases as you play harder.

With *negative* (-) values, the volume decreases as you play harder.

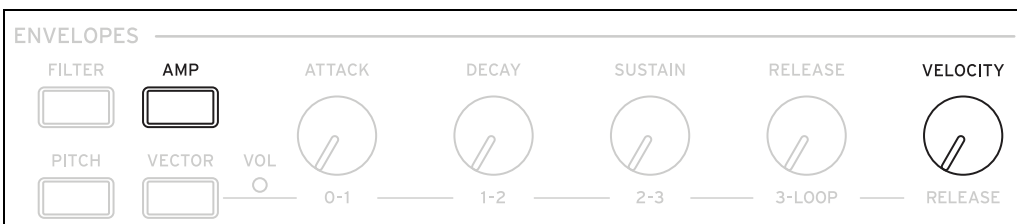

Amp

Key Track

[−100%...+100%]

This adjusts the intensity of Key Track’s effect on the level.

Pan (SHIFT-LEVEL)

[L100...L1, C0, R1...R100]

This sets the left-right pan. Note that this can be modulated per voice!

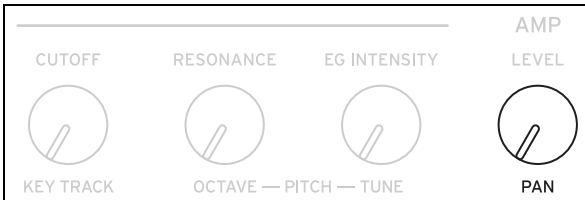

Pan LFO (INTENSITY)

[−200...+200]

This controls the intensity of Pan modulation from the Pan LFO.

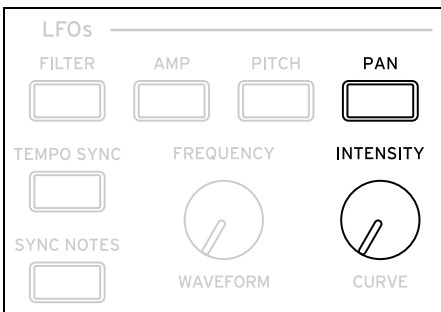

Random Pan

[Off, On]

Off: The normal pan controls, above, apply.

On: Each voice will be randomly panned across the stereo field. All other pan controls are disabled.

Amp Key Track



Keyboard tracking (“Key Track”) changes the volume as you play up and down the keyboard. This may be used to make the volume more consistent, or to create special effects.

The wavestate’s Key Track can be fairly complex, if desired. For instance, you can:

- Make the volume increase very quickly over the middle of the keyboard, and then increase more slowly—or not at all—in the higher octaves.
- Create abrupt changes at specific keys.

You can also use Amp Key Track as a general-purpose modulation source, just like the envelopes and LFOs.

For general details on how Key Track works, see “Filter Key Track” on page 45.

Differences from Filter Keyboard Track

Amp modulation works slightly differently from other mod routings, in that positive modulation is limited to 2x gain. For more information, see “Notes on Amp Modulation” on page 51. This means that, when applied to Amp **Level**, Amp Key Track’s negative **Slopes** act as if they are steeper than positive **Slopes**. This only applies to modulation of Amp Level; when modulating other destinations, Amp Key Track acts the same as Filter Key Track.

Key Track amount	Slope	Change in level
100%	-Inf	Silent in one half-step
	-12.00	Silent in five semitones
	-5.00	Silent in one octave
	-1.00	Silent in five octaves
	00	no change
	+1.00	2x in five octaves
	+5.00	2x in one octave
	+12.00	2x in five semitones
	+Inf	2x in one half-step

Modulation

Using Modulation

Modulation Overview

Most front-panel controls and on-screen parameters can be modulated. You can also create multiple modulation routings to the same destination. Each modulation routing includes a primary modulation source, an intensity, and a secondary modulation source; the three are multiplied together to create the modulation amount. Once a modulation routing is created, you can change either of the sources, but you cannot change the destination.

Adding Modulation Routings

To add a new Modulation routing:

1. In the display, select the parameter that you'd like to modulate. (If you want to modulate a knob, you can skip this step.)
2. Hold **MOD** and press **>**.

The Add New Modulation popup appears.

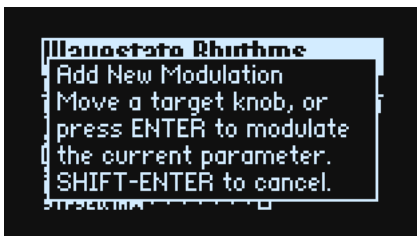

3. To select the modulation destination, move its front-panel control (e.g., **CUTOFF**), or press **ENTER** to select the parameter from step 1.

Note: If the selected parameter cannot be modulated, a message will appear on the display and then the popup will close.

4. To select the modulation source, move a controller (e.g. **WHEEL 1**) or a **MOD KNOB**, play a note (for Velocity), press a button for one of the LFOs, Envelopes, or the Step Sequencer, press **WSEQ STEPS** (for Step Pulse), or send a MIDI CC.

Alternatively, if you want to use a mod source which can't be selected from the front panel (such as Exponential Velocity or Mod Processors), press **ENTER** and manually select the mod source in the following screen.

If the message "Chan Src Only" appears, the parameter cannot be modulated from per-voice sources such as LFOs, envelopes, the Step Seq Lane, and Key Track. (The Vector Env can be used, since there is a separate Performance-level version of this envelope.) Choose a different modulation source.

5. Press **ENTER** to create the mod routing, or **SHIFT-ENTER** to cancel.

The Mods page appears, showing the new routing.

6. Set the Intensity as desired.

The maximum Intensity is typically +/- the full range of the parameter, so that regardless of the programmed value, modulation can always reach the minimum or maximum values.

7. Optionally, assign a second modulator as the Int Mod Source (Intensity Mod Source), whose value multiplies that of the main Source.

For example, you could route the Step Sequencer to Multi Filter **Crossfade**, with the overall amount of the step sequencer modulated by the Pan LFO.

Filter/Pitch Env Intensities, LFO Intensities, and Key Track Intensities

Modulation works slightly differently for these "Intensity" parameters. When you select them as a destination:

- The modulation destination is set to the main parameter: Filter Cutoff, Amp Level, Pitch Tune, or Pan
- The Source is set to the Envelope, LFO, or Key Track
- The Intensity Mod Source is set to the selected modulation source (as selected in step 4, above).

Filter and Pitch Env Velocity Intensity

Filter and Pitch Envelope Velocity Intensity cannot themselves be modulated.

Viewing and Editing Modulations

All user-created modulation routings can be viewed and edited on the Mods page.

Note: preset modulation routings, such as Filter Envelope modulation of Filter Cutoff or Pan LFO modulation of Pan, are not shown here.

To view modulation routings:

1. Press **MOD**. The screen will change to the Mods page, which displays all of the modulation routings in the current Program in a scrolling list.

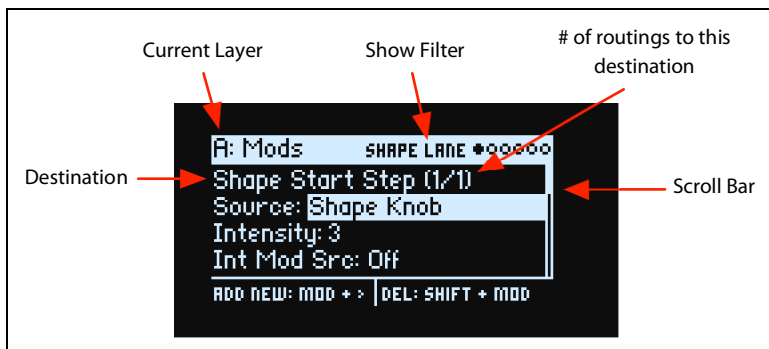

2. Hold **ENTER** and press **<** or **>** to scroll through the different routings.

Alternatively, you can cursor through each parameter, one by one; cursoring right from Int Mod Src goes to the Source parameter of the next routing.

A scroll-bar on the right side of the display shows the current location in the list.

When you see the modulation routing that you'd like to edit:

3. Use **<** and **>** to select the Source, Intensity, and Int Mod Src (Intensity Mod Source) parameters.
4. Edit the Intensity as desired using the **VALUE** knob.
5. To change the Source or Int Mod Src, select the parameter and then either move **VALUE** or press **ENTER**. The Modulation Select popup appears.

In the Modulation Select popup, the modulation sources are organized into five groups: Controllers, Mod Knobs, Generators, CC +, and CC +/- . The groups are shown in the left column, and the modulation sources are shown in the right column.

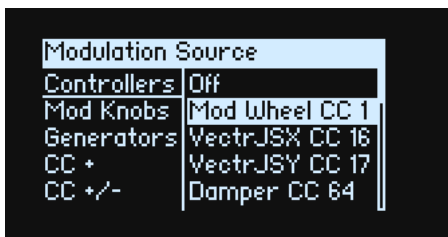

6. Use **<** and **>** to move between the columns, and **VALUE** to select items in the lists. Alternatively—and faster!—most modulation sources can be selected by pressing their associated front-panel button (for Envelopes, LFOs, and the Step Sequencer), or by holding down **ENTER** and moving a controller (such as a Mod Knob, wheel, or the Vector Joystick), playing a note on the keyboard (for Velocity), or sending MIDI data.

For information on the individual modulation sources, see “Modulation Sources” on page 57.

7. Press **ENTER** to confirm and exit the popup.

Filtering the modulation list

The list of modulations can be long. To view only the modulation routings related to a specific controller or section of the synth, use the Show parameter on the Modulation List Info page. As a shortcut to open this parameter's popup from anywhere in the UI, hold **MOD** and press **<**, as described below:

1. Hold **MOD** and press **<**.

The Show In Mod List dialog appears.

Modulation



2. Press a Lane, Envelope, LFO, or Effect button; move a **MOD KNOB**; hold **ENTER** and move a controller or play a note on the keyboard (for Velocity); send a MIDI message; or for the Filter, Amp, or Pitch sections, move a knob for that section. Use the on-screen list for other selections, such as Key Track or Mod Processors.

Note: moving a knob in this popup will not edit the knob's parameter.

3. Press **ENTER** to confirm, close the popup, and return to the Mods page. Alternatively, to exit without making a change, hold **SHIFT** and press **ENTER**.

The Show setting is included in the top line of the display: ALL, FILTER, SHAPE LANE, etc. The list will be filtered to show only the matching items—notice how much bigger the scroll-bar thumb is in the filtered list below, indicating that there are only a few items in the list.



To clear the Show setting and show all modulations:

1. Press **MOD** in the Show In Mod List dialog, or set Show to All.

Deleting a modulation routing

To delete the currently shown modulation routing:

1. Hold **SHIFT** and press **MOD**.

A confirmation message will appear, asking if you want to delete the modulation routing.

2. Press **ENTER** to confirm, or **SHIFT-ENTER** to cancel.

Mod Knobs

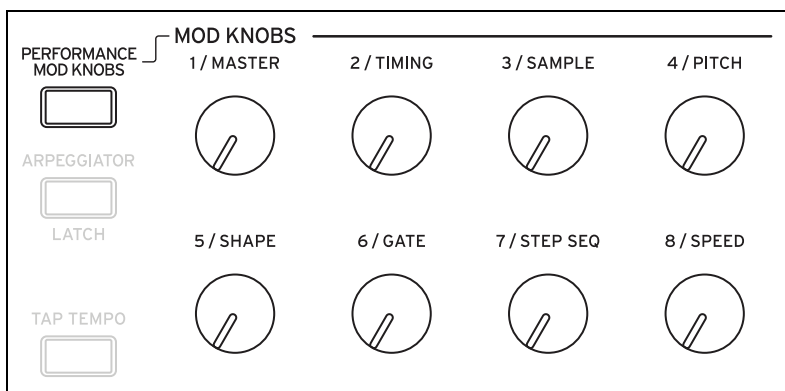

There are eight Mod Knobs per Program, each of which can modulate any number of parameters in its Program (the knob names are just suggestions). An additional layer of Performance Mod Knobs can modulate parameters throughout the entire Performance—including, specifically, the Program Mod Knobs. Each of these 40 (!) knobs sends and receives a MIDI CC; see “MIDI CC Assign” on page 88.

The Mod Knobs are designed for both real-time control and editing. Their positions are stored, as shown on the Mod Knobs page:

Modulation

A: Mod Knobs				ooooo
MASTER	TIMING	SAMPLE	PITCH	
+4.0	8.3	+100.0	-100.0	
-/+	+	-/+	-/+	
SHAPE	GATE	STEPPED	SPEED	
0.0	0.0	0.0	0.0	
+	-/+	+	-/+	

These stored values can themselves be modulated by the wheels, the vector joystick and envelope, and MIDI CCs; additionally, Program Mod Knobs can be modulated by the Performance Mod Knobs.

Each Mod Knob can be either unipolar (+) or bipolar (+/-).

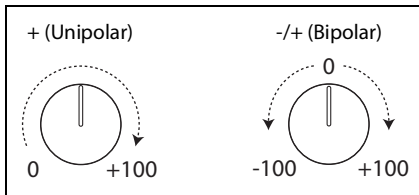

PERFORMANCE MOD KNOBS

[Off, On]

When this is on, the knobs control the Performance Mod Knobs, which can modify parameters in any or all Layers at once. When off, the knobs control the values for the current Layer's Program.

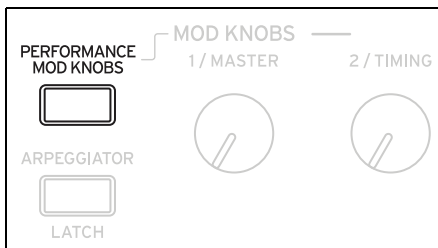

Modulation Sources

Controllers

Off

This means that no modulation source is selected.

Mod Wheel CC 1

This is the built-in Mod Wheel (unipolar MIDI CC#1).

VectrJSX CC 16 and VectrJSY CC 17

These are the X- and Y-axis, respectively, of the Vector Joystick (bipolar MIDI CCs #16 and 17).

Damper CC 64

This is the damper or sustain pedal (unipolar MIDI CC#64).

Pitch Bend

This is the Pitch Bend wheel (MIDI Pitch Bend).

Pitch Bend+ and Pitch Bend-

These let through only positive or negative pitch bend movements, respectively, ignoring the other polarity.

Velocity

This is the note-on velocity, representing how hard the note is played on the keyboard.

Modulation

Exponential Velocity

This is MIDI note-on velocity through an exponential curve. Low velocities won't have very much effect, and the differences between lower velocities won't be very noticeable. On the other hand, high velocities produce increasingly greater effects, and the differences between higher velocities will be more pronounced.

Release Velocity

This is the note-off velocity, representing how quickly the note is released from the keyboard.

Gate and Gate+Damper

Gate is triggered by a new note after all notes have been released, such as at the beginning of a phrase. Gate+Damper is similar, except that it is triggered by a new note-on after all notes and the damper are released.

Note-On Trig and NoteTrig+Damp

Note-On Trig is similar to Gate, but it triggers with every new note-on, even in the middle of a legato phrase. NoteTrig+Damp includes the damper pedal in the equation, as shown in the diagram below.

Gate, Gate+Damper, Note-On Trig, and NoteTrig+Damp

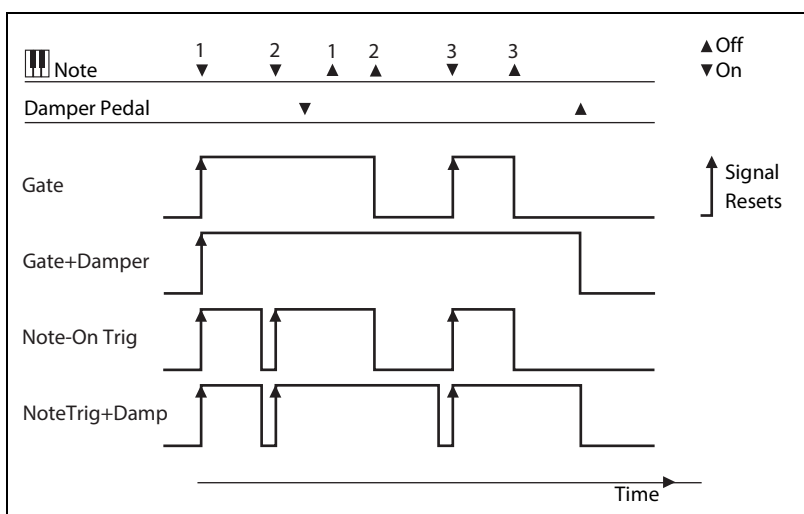

Note Number

This provides simple key tracking. C4 is the center, with a value of 0. Below C4 is negative, to a minimum at MIDI note 0; above C4 is positive, to a maximum at MIDI note 127.

Aftertouch

This receives MIDI Aftertouch, as well as aftertouch generated by pressing down on the wavestate SE keyboard.

Note: the 37-note keyboards on the wavestate and wavestate mkII do not generate aftertouch.

Depending on the **AT Source** setting on the Controllers page, *Aftertouch* receives either Channel Aftertouch, Poly Aftertouch, or both simultaneously. It can also be disabled completely. For more information, see "AT Source (Aftertouch Source)" on page 86.

Poly Aftertouch

This receives Poly Aftertouch via MIDI only.

Mod Knobs

This section of the Modulation Sources list contains the 8 Performance Mod Knobs, followed by the 8 Mod Knobs for the current Layer's Program.

Generators

Filter/Amp/Pitch Envelope

These are the three standard ADSR envelopes.

Modulation

Vector Envelope A/B/C/D

The A/B/C/D selections decide which of the Vector Envelope's four outputs to use. For instance, A is the signal that goes to Layer A's volume, which is max on the left and min on the right. C is the opposite of that, with max on the right and min on the left.

Filter/Amp/Pitch/Pan LFO

These are the four LFOs.

Filter/Amp Key Track

These are the Key Track generators from the Filter and Amp, respectively.

Mod Process 1/2

These are the two Mod Processors.

Step Seq Lane

This is the output of the Wave Sequence's Step Seq Lane. **Note:** this will not work consistently as an envelope trigger source.

Step Pulse

This generates a brief trigger pulse at the start of each Wave Sequence Step.

Tempo

This lets you use the system tempo as a modulation source. 120 is the center, for a value of 0; 60BPM is -100, and 240BPM is +100 (the value continues to increase up to 300BPM). Note that this is different from tempo synchronization; for that purpose, use the dedicated Tempo functions for the LFOs, Wave Sequence, and Vector Envelope.

Program/Performance Note Count and Program/Performance Voice Count

These use the number of notes played on the keyboard, or the number of voices being played by the synth engine, as modulation sources. The Performance variations count all notes or voices in the Performance, while the Program variations only include those in the current Program.

# Notes/Voices	Resulting value
1	0.0
2	0.01
3	0.02
...	...
101	1.0

Poly Legato

When you play a legato phrase, the first note of that phrase (and notes within 30 msec of the first note) has a Poly Legato value of 0.0. Subsequent notes in the phrase have a Poly Legato value of 1.0.

Random 1 + and 2 +

These generate a single random positive number, unique per voice, at note-on. You can use this to create random variation between voices, such as subtle differences in filter cutoff, envelope times, and so on.

Random 3 +/- and 4 +/-

These generate a single random bipolar number (either positive or negative), unique per voice, at note-on.

Constant Max

Constant Max generates the maximum modulation value, which can be thought of as either 1.0 or 100.

CC +

This is a list of all of the MIDI CCs, interpreted as unipolar signals. MIDI values 0-127 are zero to maximum modulation.

Modulation

CC +/-

This is a list of all of the MIDI CCs, interpreted as bipolar signals. MIDI value 64 is 0; values below 64 produce negative modulation, and values above 64 produce positive modulation.

Envelopes

Filter/Amp/Pitch Envelope

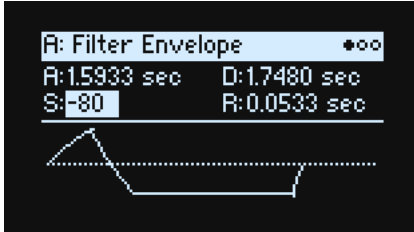

A (Attack Time) (ATTACK)

[0.0000...90.0000 sec]

This sets how long the envelope takes to rise to the peak level.

D (Decay Time) (DECAY)

[0.0000...90.0000 sec]

This sets how long it takes to settle from the peak to the **Sustain** level.

S (Sustain Level) (SUSTAIN)

[-100...+100 (Filter and Pitch) or 0...+100 (Amp)]

This sets the level at the end of the **Decay** time. Once it reaches the **Sustain** level, the envelope will stay there until note-off, unless it is restarted via the **Trigger Source**. The Filter and Pitch Envelopes can have either positive or negative **Sustain** levels, while the Amp Envelope has only positive **Sustain** levels.

R (Release Time) (RELEASE)

[0.0000...90.0000 sec]

This sets how long it takes the envelope to return to 0 after releasing a note.

Filter/Amp/Pitch Env Curve

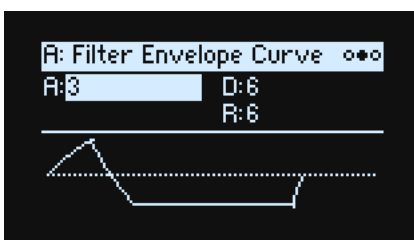

Often, envelopes are pictured as being made out of straight lines. In actuality, they are more likely to be made out of curves.

In other words, each segment's level will change quickly at first, and then slow down as it approaches the next point. This tends to sound better than straight, linear segments.

Classic analog synth envelopes made these curved shapes naturally. The wavestate goes a step further than vintage synths, however, and lets you control the amount of curvature separately for each envelope segment.

When you change the curvature, the envelope times remain the same. However, greater curvatures will tend to *sound* faster, because the value changes more quickly at the beginning.

Envelopes

Different curve settings for up and down

Generally, upwards segments use different curvature settings than downward segments. For instance, a curve of 3 is a good default setting for upward segments, such as **Attack**. On the other hand, a curve of 6 or more is good for downward segments, such as **Decay** and **Release**.

Envelope Curve

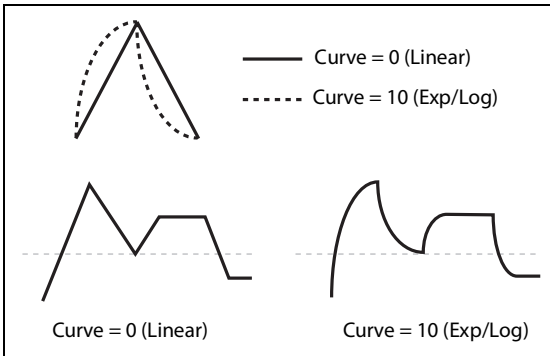

A (Attack) (SHIFT-ATTACK)

D (Decay) (SHIFT-DECAY)

R (Release) (SHIFT-RELEASE)

[0 (Linear), 1...9, 10 (exp/log)]

These set the curvatures of the **Attack**, **Decay**, and **Release** segments, respectively. Hold **SHIFT** and move the **ATTACK**, **DECAY**, or **RELEASE** knobs to edit these parameters directly.

Filter/Amp/Pitch Envelope Trigger

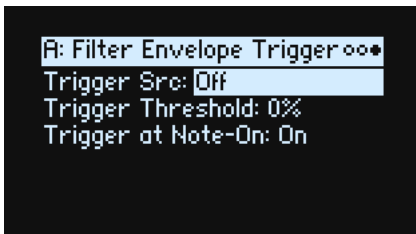

Trigger Src (Trigger Source)

[List of modulation sources]

This selects a source to start the envelope, or re-start it if it is already playing. For instance, you can use a tempo-synced LFO to trigger the envelope in a repeating rhythm.

Envelopes started or re-started by the **Trigger Source** work slightly differently from normal. The **Decay** always takes its full time, even if **Sustain** is at maximum; in this case, it acts as a hold time. Following the **Decay** time, the envelope goes to 0 over the **Release** time, even if the note is still being held.

Trigger Threshold

[-100%...+100%]

This sets the modulation level which will trigger the envelope. Among other things, you can use this to adjust the exact point in an LFO's phase at which the envelope will be reset, effectively controlling its "groove" against other rhythmic effects.

When the threshold is *positive* (or 0), the envelope resets when the **Trigger Source** value passes through the threshold moving upwards. In other words, if the value has been below the **Threshold**, and then changes so that it is equal to or greater than the **Threshold**, the envelope resets.

When the threshold is *negative*, the envelope resets when the **Trigger Source** value passes through the threshold moving downwards. In other words, if the value has been above the **Threshold**, and then changes so that it is equal to or below the **Threshold**, the envelope resets.

Envelopes

Note: modulation sources may not always reliably reach the extreme values of +100 or -100. This can happen due to smoothing, or with LFOs when using certain shapes and faster speeds. If this is the case, **Thresholds** of +100 or -100 will cause inconsistent behavior. To avoid this issue, reduce the **Threshold** until the Envelope resets consistently.

Trigger at Note-On

[Off, On]

Trigger at Note-On is available for the Filter and Pitch Envelopes only. The Amp Envelope always triggers at note-on.

On: The envelope will start automatically at note-on. This is the default.

Off: The envelope will only start via the **Trigger Source**.

Note: The **Trigger Source's** value at note-on can cause the envelope to trigger instantly. If the **Threshold** is *positive* or *0*, this will happen if the value is at or above the **Threshold**; if the **Threshold** is *negative*, this will happen if the value is at or below the **Threshold**.

LFOs

Filter/Amp/Pitch/Pan LFO

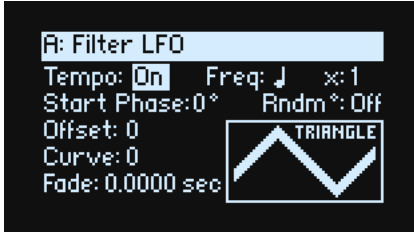

The four LFOs—Filter, Amp, Pitch, and Pan—all work identically.

Tempo (TEMPO SYNC)

[Off, On]

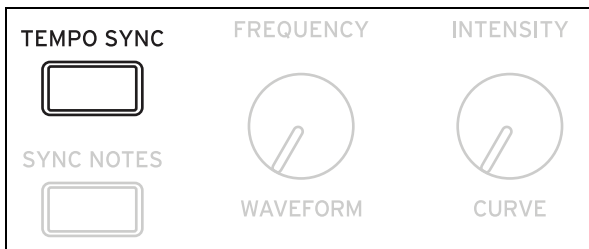

On: The LFO synchronizes to the system tempo, with its speed controlled by **Base Note** and **Multiply**.

Off: The LFO speed is controlled by the **Frequency** parameter, in Hz.

Base Note (FREQUENCY)

[List of rhythmic values]

If **Tempo** is *On*, this sets the basic speed of the LFO. The values range from a 32nd note to a double breve (four whole notes), including dotted notes and triplets.

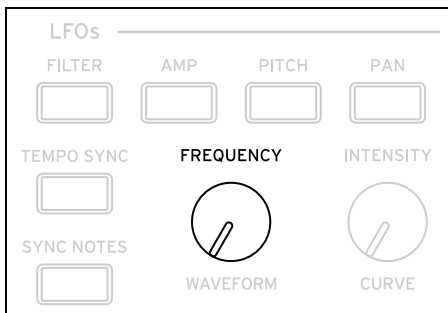

x (Multiply Base Note by...)

[1...32]

If **Tempo** is *On*, this multiplies the length of the **Base Note**. For instance, if the **Base Note** is set to a sixteenth note, and **Times** is set to 3, the LFO will cycle over a dotted eighth note.

Frequency (FREQUENCY)

[0.001...32.000 Hz]

If **Tempo** is *Off*, the LFO speed is set in Hz.

LFOs

Waveform (WAVEFORM)

[Triangle...Random6 (Continuous)]

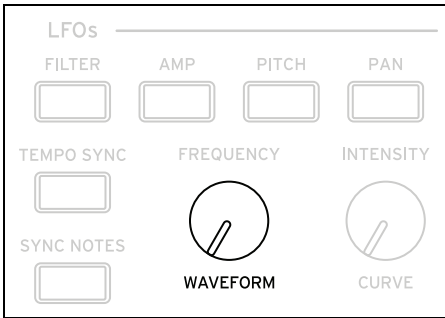

Most of the waveforms are self-explanatory, but a few will benefit from more details:

GTR (*Guitar*) is intended for guitar vibrato. It is positive-only, so that when used for pitch, it only bends upwards.

RND 1 (*Random 1*) generates traditional sample and hold waveforms: random level changes with steady timing.

RND 2 (*Random 2*) randomizes both levels and timing.

RND 3 (*Random 3*) generates a pulse wave with random timing.

RND 4-6 are smoothed versions of *Random 1-3*, with slopes instead of steps. Use them to create gentler random variations.

LFO Waveforms

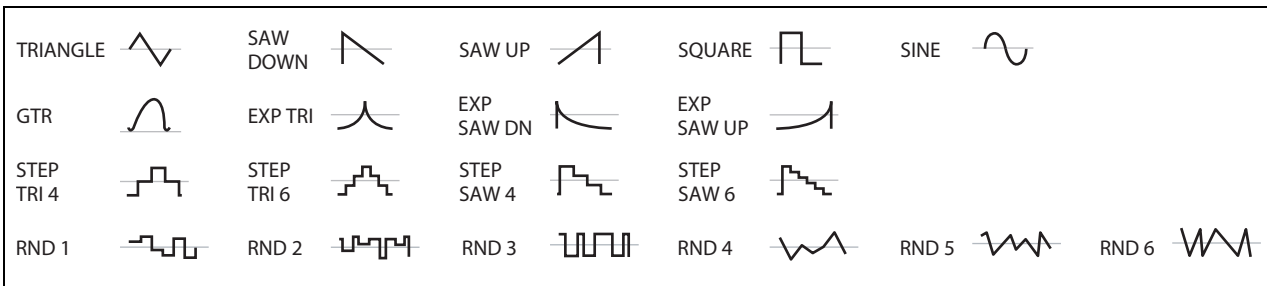

Start Phase

[-180...+180]

This controls the phase of the waveform when the LFO starts (see “When do Delay, Fade, Start Phase, and Random Phase apply?” on page 67). If **Random Start Phase** is *On*, or if one of the Random waveforms is selected, this parameter is not shown.

Rndm° (Random Start Phase)

[Off, On]

When **Random Start Phase** is *On*, the LFO will start at a different, random phase every time. If one of the Random waveforms is selected, this parameter is not shown.

Offset

[-100...+100]

By default, almost all of the LFO waveforms are centered around 0, and then swing all the way from -100 to +100. **Offset** lets you shift the LFO up and down, so that—for instance—it’s centered on 50, and then swings from -50 to +150.

For example, let’s say that you’re using an LFO for vibrato. If **Offset** is 0, the vibrato will be centered on the note’s original pitch, bending it both up and down.

If **Offset** is +100, on the other hand, the vibrato will only raise the pitch above the original note.

LFOs

Offset settings and pitch change produced by vibrato

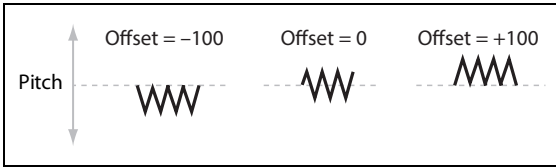

The one exception to this is the *Guitar* waveform, which is designed to emulate bending a string on a guitar—so that the pitch only goes up, and not down. Because of this, the waveform is centered on 50, and not on 0. Of course, you can always use a negative **Offset** to shift it back down below 0 again!

Offset affects the signal *after* the **Shape** function, as shown below:

LFO Signal Flow

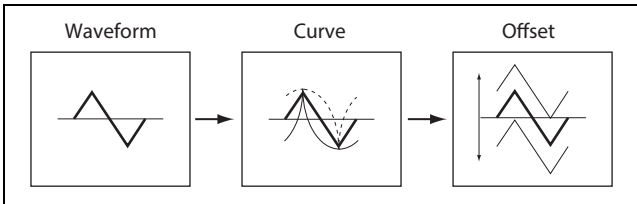

Curve (CURVE)

[−100...+100]

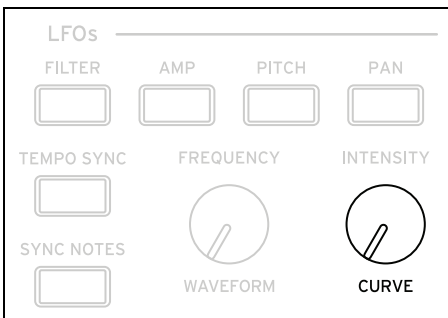

Curve adds curvature to the basic waveform. As you can see in the graphic below, this can make the waveforms either more rounded or more extreme. It can also be useful to emphasize certain value ranges, and deemphasize others.

For example, let's say that you are using a triangle LFO to modulate filter cutoff. If **Curve** emphasizes the high value range, the filter will spend more time at the higher frequencies. If it emphasizes the low range, the filter will spend more time at the lower frequencies.

For control over whether the curve is *Asymmetric* or *Symmetric* around 0, see “Curve Mode” on page 68.

LFO Curve and Mode

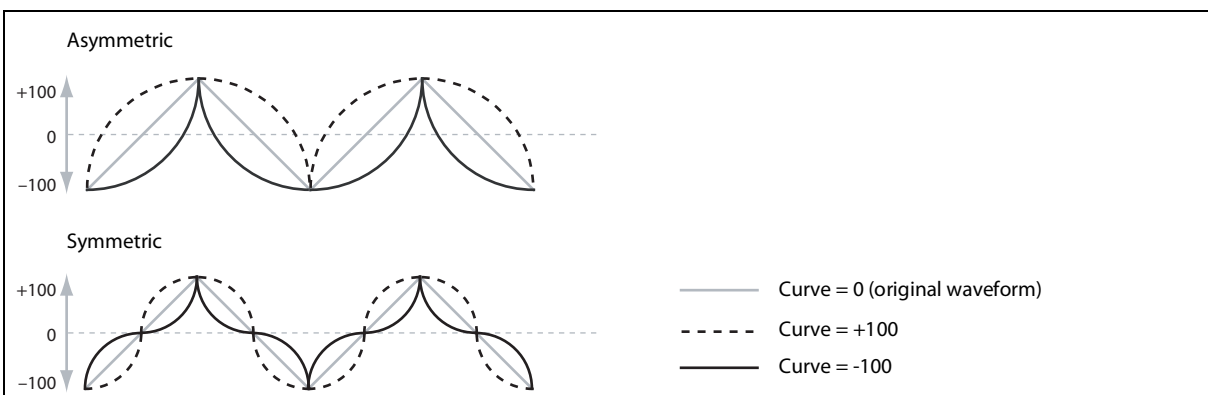

Note: **Curve** does *not* affect the *Square* and *Random 3* waveforms, since their values are always either +100 or -100.

LFOs

Fade

[0.0000...9.9000 sec]

The LFO can fade in gradually, instead of starting immediately at full strength. This sets the time until the LFO reaches maximum amplitude. If **Delay** is used (see “Delay” on page 68), the **Fade** starts after the **Delay** is complete. See also “When do Delay, Fade, Start Phase, and Random Phase apply?” below.

SYNC NOTES

[Off, On]

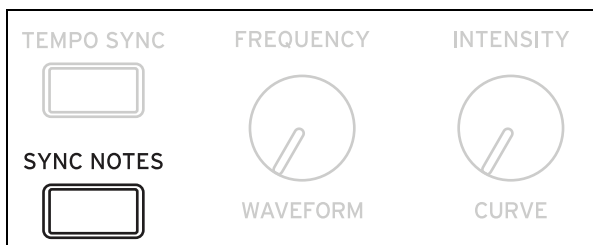

This is controlled by the **SYNC NOTES** button.

Off: The LFO starts each time you press a key, and an independent LFO runs for each note. This is the default.

On: The LFOs for all notes in the Program will be synchronized together. See “Sync Notes Mode” on page 68.

When do Delay, Fade, Start Phase, and Random Phase apply?

Delay, **Fade**, **Start Phase**, and **Random Phase** apply when the LFO first starts (which depends on Sync Notes, as shown below), and when the LFO is reset via the **Trigger Source**.

Delay, Fade, Start/Random Phase, and Sync Notes

Sync Notes setting	Delay, Fade, Start Phase, and Random Phase apply at...
Off	Note-on
Sync Notes	First note in phrase
Free Run	Performance/Program selection, before any notes are played

Filter/Amp/Pitch/Pan LFO Details

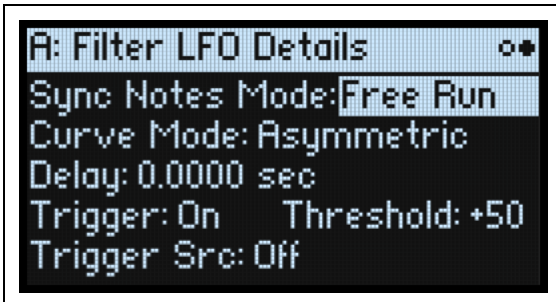

Sync Notes Mode

[Sync Notes, Free Run]

This controls how the LFO behaves when **SYNC NOTES** is enabled.

Sync Notes: Each note has its own LFO. If no other notes are sounding, the LFO starts as it would normally. If other notes are sounding, the LFO starts by matching the phase of the oldest sounding note. The result is that the LFOs for all of the notes are initially synchronized together. This option is generally the most effective for synchronizing with tempo and Motion Sequences.

Note: With *Sync Notes*, each note's LFO speed may still be different if modulated by note number, velocity, key scaling, or other note-specific modulation sources.

Free Run: All notes in the Program share a single LFO. This is particularly useful if you want a slow LFO shape to continue running under multiple phrases, or under an arpeggiator pattern. The LFO starts running as soon as you select the Program or Performance, before any notes are played.

Curve Mode

[Symmetric, Asymmetric]

This controls the shape created by **Curve**; see "LFO Curve and Mode" on page 66.

Asymmetric produces a single curve, extending from -100 to +100.

Symmetric produces two matching curves extending outwards from 0 to -100 and +100, respectively.

For more information, see the similar feature in Mod Processor Curve, under "Mode" on page 74.

Delay

[0.0000...22.0000 sec]

This sets the time until the LFO starts. Depending on the **Sync Notes** settings, this may be the time from note-on, from the start of a phrase, or simply from the time that the sound is selected. It also applies when the LFO is triggered manually. For more information, see "When do Delay, Fade, Start Phase, and Random Phase apply?" on page 67. The **Fade** time begins after the **Delay** is complete.

Trigger

[Off, On]

This enables the **Trigger Source** below. The trigger resets the LFO to the **Start Phase**, and starts the **Delay** and **Fade** times.

Important: The **Trigger** settings apply only when **Sync Notes Mode** is set to *Free Run*, and **SYNC NOTES** is *On*.

On: The LFO will restart according to the **Trigger Source** and **Threshold** settings. This is the default.

Off: The **Trigger Source** will be ignored. This lets you quickly disable the function without having to set the **Trigger Source** to *None*.

Trigger Src (Trigger Source)

[List of modulation sources]

This selects a source to re-start the LFO from the **Start Phase**. For example, you can insert a MIDI CC trigger into a MIDI sequence so that a free-running LFO sounds the same every time the sequence is played.

You can also use *Gate + Damper* to reset the LFO at the start of phrases played on the keyboard. Note that this may not behave exactly the same as *Sync Notes*.

Trigger Threshold

[-100%...+100%]

This sets the modulation level which will trigger the LFO.

When the threshold is *positive* (or 0), the LFO resets when the value passes through the threshold moving upwards. In other words, if the value has been below the **Threshold**, and then changes so that it is equal to or greater than the **Threshold**, the LFO resets.

When the threshold is *negative*, the LFO resets when the value passes through the threshold moving downwards. In other words, if the value has been above the **Threshold**, and then changes so that it is equal to or below the **Threshold**, the LFO resets.

Note: modulation sources may not always reliably reach the extreme values of +100 or -100. This can happen due to smoothing, or with LFOs when using certain shapes and faster speeds. If this is the case, **Thresholds** of +100 or -100 will cause inconsistent behavior. To avoid this issue, reduce the **Threshold** until the LFO resets consistently.

Modulation Processors

Overview

Modulation Processors transform a modulation signal to make it into something new. The original modulation signal also remains available. There are two Modulation Processors per Program.

The Modulation Processor outputs appear in the list of modulation sources, just like the LFOs and Envelopes.

Type

[Gate, Offset, Quantize, Scale, Curve, Smooth, Sum]

This controls the type of processing performed by the Mod Processor. Each is described in detail below.

Gate



This lets you switch between two modulation sources (or fixed values) using a third modulation source.

It's similar to an audio gate with a side-chain, but with even more flexibility—since you get to choose what happens when the gate is closed (below the threshold), as well as when it's open (above the threshold).

For instance, you can use Gate to:

- Apply pitch-bend or other effects to some notes, but not to others (using **Control at Note-On Only**)
- Apply modulation only after the source reaches a certain threshold—for instance, use Velocity to modulate an LFO's frequency, but only once Velocity is greater than 90
- Use a controller to switch between two different LFOs (or any two modulation sources)

Cntrl (Control Source)

[List of Modulation Sources]

This selects the modulation source to control the Gate.

Threshold

[-100...+100]

This sets the value of the Control Source at which the gate opens or closes.

Control at Note-On Only

[Off, On]

When this is *On*, the value of the Control Source is only evaluated at note-on. The selected output will then remain active throughout the duration of the note, regardless of any subsequent change in the Control Source's value. Note that the output value itself can continue to change; only the selection of Below or Above is fixed.

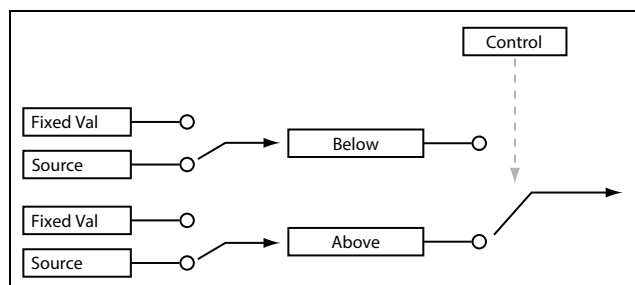

Below (Below Threshold)

[Fixed Val, Source]

This sets the output of the Gate when the Control Source is less than the **Threshold**. When this is set to *Fixed Val*, you can set a value between -100% and $+100\%$. When it is set to *Source*, you can select any modulation source.

Above (At & Above Threshold)

[Fixed Val, Source]

This sets the output of the Gate when the Control Source is equal to or greater than the **Threshold**.

Offset

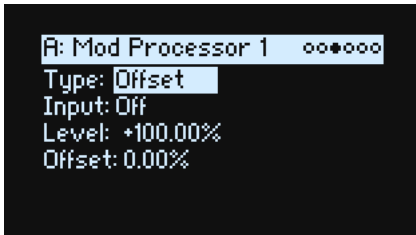

This adds a constant positive or negative offset to a modulation source, and also allows you to double the gain.

Input

[List of Modulation Sources]

This selects the input for the Mod Processor.

Level

[-200%...+200%]

$+200\%$ doubles the original signal level, while -200% doubles the level and inverts the phase.

Offset

[-200%...+200%]

This controls how the **Input** is shifted up or down.

$+200\%$ shifts an input of -100 all the way to $+100$.

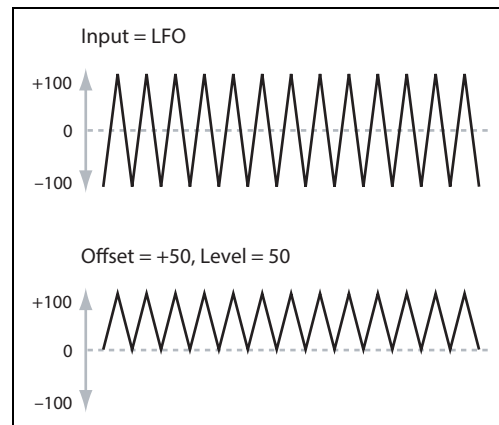

Converting from bipolar to unipolar

You can use *Offset* to convert a bipolar modulation source (both negative and positive), such as an LFO, to a unipolar signal (positive only). To do so:

1. **Select the LFO as the source.**
2. **Set the Input Amount to 50%.**

This cuts the overall level of the LFO in half.

3. **Set the Offset to 50%.**

This shifts the LFO signal up, so that it now swings between 0 and +100.

Converting from unipolar to bipolar

Similarly, you can convert a unipolar modulation source to a bipolar signal:

1. **Select the modulation source as desired.**
2. **Set the Input Amount to +200%.**

This doubles the overall level of the modulation source.

3. **Set the Offset to -100%.**

This shifts the Modulation signal down, so that it ranges from -100 to $+100$.

Quantize

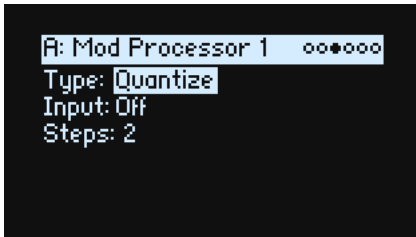

This changes a continuous signal into a series of discrete steps. Use this to change the shape of LFOs or envelopes, or to force a controller to land on a few specific values.

Input

[List of Modulation Sources]

This selects the input for the Mod Processor.

Steps

[1...32]

This controls the severity of the effect. Lower values create more “steppy” effects.

For instance, when this is set to 2, there will be “steps” at 0, 50, and 100. With a bipolar source, there will also be steps at -50 and -100.

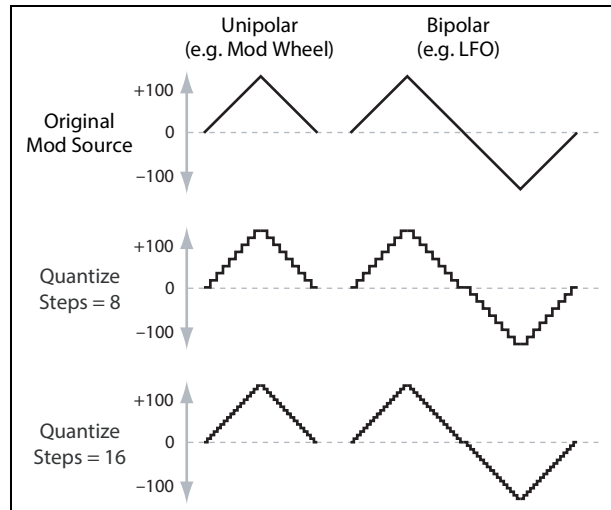

Quantized Pitch Bend

You can use Quantize to create quantized pitch bend, for fret-dragging effects, brass rips, and more.

1. Open the Add New Modulation popup (**MOD + >**), and set the Destination to *Pitch Tune*.
2. Press **ENTER** to close Add New Modulation and bring up the Modulation Source popup (since there isn't a front-panel control to select for Mod Processors).
3. Press the PAN LFO button to jump to the middle of the Generators section, and then scroll down to select Mod Processor 1. Press **ENTER** to confirm.
4. Set the Intensity to any exact half-step value: +5.00, +7.00, etc.
5. Set Mod Processor 1's Type to *Quantize*, and set the Input to *Pitch Bend*.
6. Set Steps to the same number you used for Intensity, above.
7. On the Pitch Mod page, set both Pitch Bend Up and Pitch Bend Down to 0 (so that only the Mod Processor version will affect Pitch).

Now, moving the Pitch Bend wheel will create quantized pitch bends.

Scale

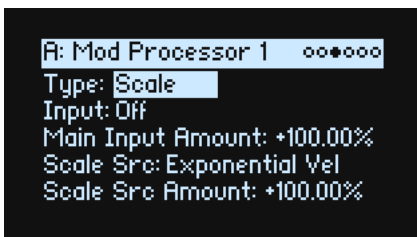

This processor uses a modulation source to scale the input. For instance, you can control the amount of an LFO with an Envelope, or control the amount of an Envelope with a MIDI controller.

Input

[List of Modulation Sources]

This selects the main input for the Mod Processor.

Main Input Amount

[−100%...+100%]

This controls the gain and polarity of the input signal, before being scaled by the **Scale Source**. Input from the **Scale Source** then adds to this initial amount.

Even if the **Main Input Amount** is set to 0, the **Scale Source** can still control the final amount of the Main Input over the full +/-100 range.

Scale Src (Scale Source)

[List of Modulation Sources]

This selects the modulation source to scale the **Input**.

Scale Src Amount (Scale Source Amount)

[−100%...+100%]

This controls the gain and polarity of the effect of the **Scale Source**. For example, the main input is an LFO and the **Scale Source** is an Envelope, positive settings mean that the Envelope will increase the amount of LFO.

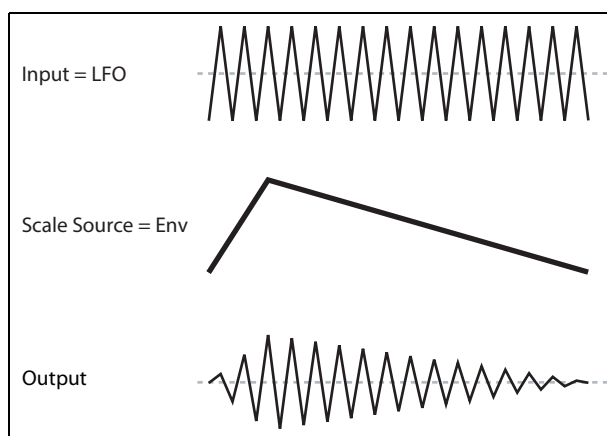

Curve

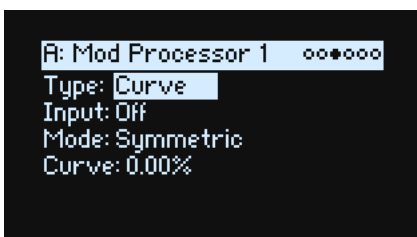

Curve can create custom controller curves, such as exponential joystick, logarithmic velocity, and so on. It can also alter the shape of programmable modulation sources, such as Envelopes and LFOs.

Note: Curve primarily affects modulation signals which already have some amount of slope, such as envelopes, triangle and sine LFOs, and so on. If the signal has only abrupt transitions from one value to another, like a classic sample-and-hold waveform, Curve will affect the values, but not the transitions between them. Curve does not affect signals which contain only maximum, 0, or minimum values, such as square waves.

Input

[List of Modulation Sources]

This selects the input for the Mod Processor.

Mode

[Symmetric, Asymmetric]

Asymmetric produces a single curve, extending from -100 to +100.

Symmetric produces two matching curves extending outwards from 0 to -100 and +100, respectively.

Curve and Mode

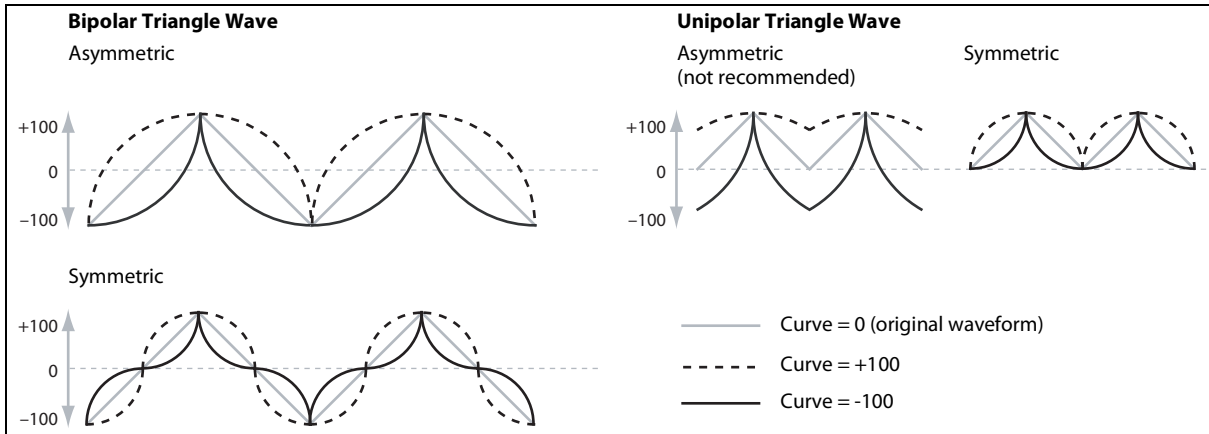

Curve

[-100.00%...+100.00%]

This controls the amount of curvature, and whether the curves are concave or convex.

As you can see in the graphic examples, the curve will emphasize certain value ranges, and deemphasize others. For example, let's say that you are using a triangle LFO, through Curve, to modulate filter cutoff. If Curve emphasizes high values, the filter will spend more time at higher frequencies. If it emphasizes low values, the filter will spend more time at lower frequencies.

Mode	Input	Curve	Result
Symmetric	Unipolar	Positive (+)	emphasizes upper value range
		Negative (-)	emphasizes lower value range
	Bipolar	Positive (+)	emphasizes both upper and lower value ranges, and deemphasizes the center
		Negative (-)	emphasizes center value range, around 0
Asymmetric	Unipolar	Positive (+)	emphasizes extreme upper range, with offset
		Negative (-)	emphasizes extreme lower range, with offset
	Bipolar	Positive (+)	emphasizes upper value range
		Negative (-)	emphasizes lower value range

Bipolar and Unipolar modulation sources

To understand Curve, it helps to understand the difference between *bipolar* and *unipolar* modulation sources.

Bipolar sources can swing all the way from -100 to +100, with 0 in the middle. Most LFOs are bipolar, for instance; so is Pitch Bend. Generally, bipolar modulation sources will work better with the *Asymmetric* mode, but *Symmetric* may also produce interesting results.

Unipolar sources only go from 0 to 100, with 50 in the middle. Often, MIDI controllers are unipolar (though you can also select bipolar versions). Envelopes are usually programmed to be unipolar, even though the Filter and Pitch Envelopes allow negative levels.

With unipolar sources, it's almost always better to use the *Symmetric* mode; *Asymmetric* can cause offsets and other strange results.

Smooth

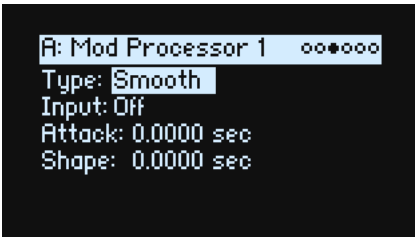

This creates more gentle transitions between values, smoothing out abrupt changes such as a quick move on a wheel or a sharp edge on an LFO.

You have separate control of the amount of smoothing during the attack (when the signal is increasing) and decay (when it's decreasing).

Low settings provide subtle controller smoothing, creating more gradual aftertouch, for instance. Higher settings create auto-fade effects, transforming a quick gesture into a longer fade-in and/or fade-out event.

Smoothing can also be used to alter the shape of programmable mod sources, such as LFOs and envelopes. For instance, you can turn a “blip” into a simple envelope shape, as shown below.

Input

[List of Modulation Sources]

This selects the input for the Mod Processor.

Attack

[0.0000... 10.0000 sec]

This controls how long it takes the smoother to reach a new, *higher* value. Higher settings mean longer times.

Decay

[0.0000... 10.0000 sec]

This controls how long it takes the smoother to reach a new, *lower* value. Higher settings mean longer times.

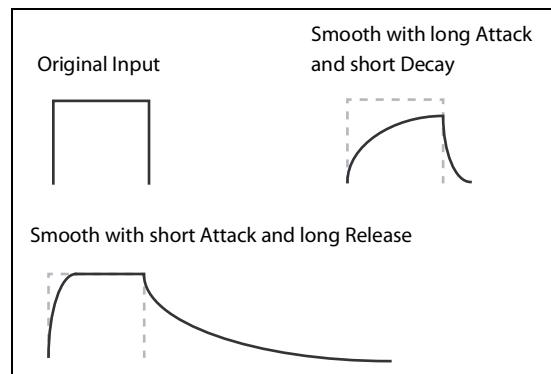

Sum

```
A: Mod Processor 1 000000
Type: Sum
Input: Off
Main Input Amount: +100.00%
Sum Src: Exponential Vel
Sum Src Amount: +100.00%
```

Sum adds two modulation sources together. This is useful if you want to process the combination of two or more signals: for instance, to merge an LFO and an envelope, and then smooth the result.

Input

[List of Modulation Sources]

This selects the main input for the Mod Processor.

Main Input Amount

[-100%...+100%]

This controls the gain and polarity of the **Input**.

Sum Src (Sum Source)

[List of Modulation Sources]

This selects the modulation source to merge into the **Input**.

Sum Source Amount

[-100%...+100%]

This controls the gain and polarity of the **Sum Source**.

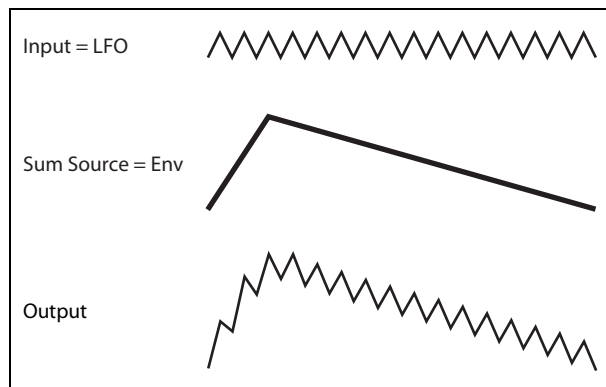

Effects

Overview

Each Layer has its own **PRE FX**, **MOD FX**, and **DELAY**. Additionally, the Performance has a master **REVERB** and parametric EQ. See “Structure” on page 3.

SHIFT-press or double-press the effects buttons to turn them on and off.

Main page



Type (EFFECT TYPE)

[List of Effects]

For each effect, you can select a **Type** (or “algorithm”) and a **Preset** within that **Type**. For full lists of Effect Types, see “Pre FX,” “Mod FX,” “Delay,” and “Master Reverb,” below.

“All” types (*Delay All*, *Chorus All*, etc.) let you select **Presets** from all related algorithms.

Preset (SHIFT-EFFECT TYPE)

[List of Presets]

These are the presets available for the selected **Type**.

Wet/Dry (WET/DRY)

[Dry, 1:99...99:1, Wet]

This controls the balance between the original signal (*Dry*) and the effected signal (*Wet*).

Level controls

Additional level-related parameters may be available on-screen, depending on the effect **Type**.

Input Trim

[-Inf, -84.9...0.0 dB]

This controls the volume level into the effect. Use this to alter the response of effects such as the *Waveshaper*, or to compensate for gain increases in effects such as the *Talking Modulator*.

Volume

[-Inf, -84.9...+12.0 dB]

This controls the post-**Drive** output of the **Guitar Amp**. Use it to compensate for level changes caused by **Drive**.

Output Level

[-Inf, -84.9...0.0 dB]

This controls the output volume from the effect. Use it to compensate for level changes in effects such as the *Waveshaper*.

Gain Adjust

[-Inf, -84.9...+24.0 dB]

This is similar to Output Level, but provides up to 24dB of gain. It appears only for the **Modern Compressor**.

Edit page

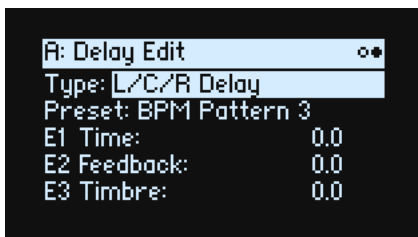

The **EDIT 1/2/3** controls (E1/E2/E3 on the display) are macros which may control multiple internal parameters, and which may be set up differently for each **Preset**. There are general conventions for the **EDIT** knobs of each effect **Type**, as reflected in the on-screen labels.

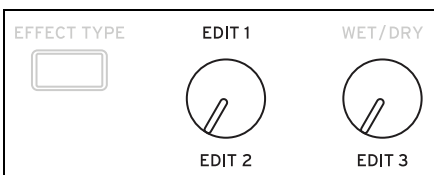

Pre FX



You can select one of the following effect **Types** for the Pre FX slot.

Decimator

This stereo effect models vintage digital gear, lowering the sampling frequency and reducing bit depth.

Graphic EQ

This is a stereo graphic EQ with macro controls.

Guitar Amp

This mono effect models a selection of guitar amps and speaker cabinets, for everything from subtle saturation to roaring distortion.

Modern Compressor

This is a stereo compressor with a modern sound.

Parametric EQ

This is a stereo EQ with a single adjustable parametric band. Presets may include additional EQ.

Red Compressor

Need to play chordal passages with smooth, even dynamics? Then, look no further: this mono compressor is modeled on a pedal whose clean sound made it hugely popular.

Ring Modulator

This stereo effect creates a metallic sound by modulating the input via an LFO-controlled oscillator.

Tremolo

This stereo effect modulates volume with an LFO, optionally controlled by an envelope follower.

Wave Shaper

This stereo effect is very sensitive to input level. Different table selections generate various types of overtones and distortion.

Mod FX

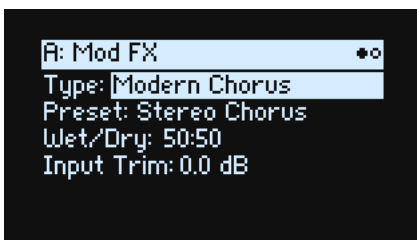

You can select one of the following effect **Types** for the Mod FX slot.

Black Chorus/Flanger

This is modeled after a classic mono-in, stereo-out chorus known for both crystal-clean tone and quiet operation, and especially well-suited to tine electric pianos.

Black Phase

This mono phaser is inspired by a classic European pedal effect.

CX-3 Vibrato Chorus

This effect models the scanning chorus and vibrato circuitry of a vintage organ.

EP Chorus

This is inspired by a rare chorus built into a famous modified tine piano.

Harmonic Chorus

This stereo effect applies chorus only to higher frequencies—particularly useful for bass sounds. Some presets use feedback to turn the chorus into a flanger.

Modern Chorus

This stereo effect adds thickness and warmth to the sound by modulating the delay time of the input signal.

Modern Phaser

This is a modern, stereo phaser effect.

Orange Phase

This is a model of a classic, orange-colored mono phaser pedal. It's superseded by the "V2" version below, but is still available for compatibility with older sounds.

Orange Phase V2

This is an improved model of a family of mono phaser pedals—in "90" and "100" versions—which are favorites on many recordings. It's useful for adding sparkle, animating chord passages, and widening and fattening the sound.

Polysix Ensemble

This models the mono-in, stereo-out ensemble effect built into the classic Korg Polysix synthesizer.

Small Phase

This models a classic mono phaser made in New York City during the 70s, with its warm, rich tone and liquid transparency.

Talking Modulator

This mono effect applies vowel formant filters, like a human voice, to the input.

Vintage Chorus

This models a mono chorus best-known for being built into a guitar amp. **Speed** and **Depth** provide a broader range of sounds than the original device.

Vintage Flanger

A model of a truly classic mono analogue flanger. This amazing stompbox's bucket-brigade technology provides a sweeping, whooshing sound, perfect for chords.

Vintage/Custom Wah

This stereo effect models the tonal character of a vintage wah pedal.

Vox Wah

This effect is modeled on the unique “throaty” tones of two legendary VOX wah pedals: the V847 and the V848 Clyde McCoy model.

Delay

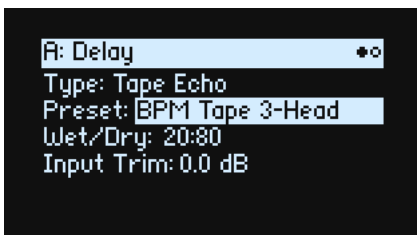

You can select one of the following effect **Types** for the Delay slot.

L/C/R Delay

This mono-in, stereo-out multitap delay has three taps panned to the left, right, and center respectively.

Multiband Mod Delay

This monster effect divides the input signal into four frequency bands, with a modulatable delay for each band. It can produce everything from complex, frequency-specific delays to thick choruses.

Reverse Delay

This effect includes a reverse delay followed by additional left and right delays. Presets provide various feedback options.

Stereo/Cross Delay

This true-stereo delay provides up to 2,730 msec of delay time.

Tape Echo

This effect models a tape echo with up to three playback heads, including tape saturation.

Master Reverb

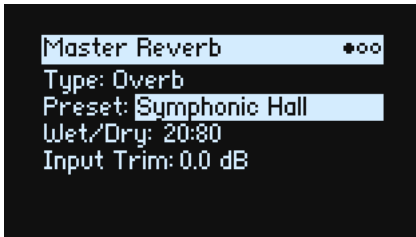

Early Reflections

This provides different early reflection patterns, useful for small ambiences, gated reverbs, and reverse effects.

Overb

The Overb features a high-quality, diffusion-based reverb core, including randomization for richer and smoother reverb timbres.

Master EQ

Performances include a dedicated parametric EQ. To edit the EQ:

1. Press **REVERB** and then **PAGE-**.

The Master EQ page will appear.

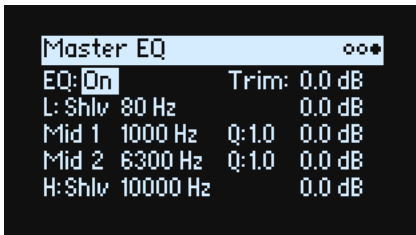

EQ On/Off enables and disables the EQ. Use **Trim** to compensate for EQ boosts. The **L** (Low) and **H** (High) bands can be set to *Peak*, *Shlv* (Shelving), or *Cut* (Low cut/High cut).

Randomize

Randomize uses a combination of preset selection and select value randomization, rather than direct randomization of all parameters.

Using Randomize

To randomize the entire Performance:

1. Press the  (Randomize) button.

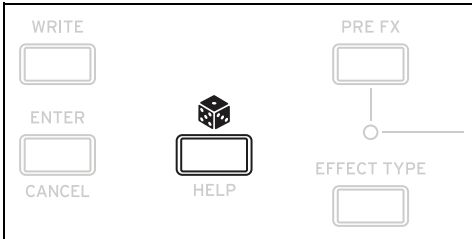

The Randomize page will appear, with **Scope** set to *Performance* by default. If **Scope** has been previously changed to another setting, hold  and press **PERFORM**.

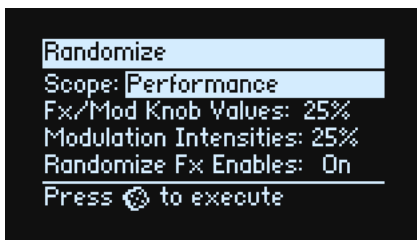

Depending on the Scope, additional settings may appear:

Fx/Mod Knob Values randomizes the Mod Knobs (Program and/or Performance, according to **Scope**) and Effects Edit 1/2/3 by the specified percentage.



Modulation Intensities randomizes the standard LFO and Envelope intensities for Filter, Amp, Pitch, and Pan.

Randomize Fx Enables controls the On/Off settings for the Effects (with probability weighted towards On).

Speed randomizes Wave Sequence Speed.

2. Press  again to randomize everything in all layers, and then **ENTER** to confirm.

To randomize a specific section of the synth:

1. Press and hold .
2. While holding , press the button for the desired section (**PERFORM**, **WAVE SEQUENCE SELECT**, **ARPEGGIATOR**, **FILTER TYPE**, **LAYER A...D**, or any Effect or Wave Sequence Lane), or move a Filter, Amp, Pitch, or MOD knob.

The Randomize page will appear, with the selected **Scope**. You can still change the **Scope** again, if desired. Additional **Scope** options are available from the on-screen menu.

3. Press  to execute the randomization, and then **ENTER** to confirm.

Utility

System Setup

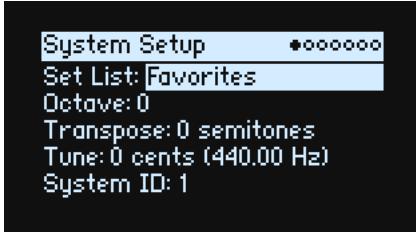

Set List

[List of Set Lists]

This selects the current Set List, which maps Performances to the SET LIST buttons. You can store many Set Lists, and change between them as you like.

Octave (OCTAVE buttons)

[-4...+4]

This shifts the keyboard up or down by up to four octaves. It's also generally controlled by the front panel octave buttons (although these can optionally control scale selection, instead; see "Octave Selects Scale" on page 89).

 The wavestate module does not have front-panel **OCTAVE** buttons.

Transpose

[-12...+00...+12]

This adjusts the pitch in semitone steps over a ± 1 octave range.

Note: **Transpose** is affected by the **Convert Position** setting; see "Chan+Poly: The mod source "Aftertouch" receives both Channel and Poly Aftertouch. If both are sent simultaneously, the most recent value is used." on page 86.

Tune

[-50 (427.47Hz)...+50 (452.89Hz)]

This adjusts the overall tuning of the entire wavestate in one-cent units, over a range of ± 50 cents. (A cent is 1/100 of a semitone.) At the default of 0, A4 = 440 Hz.

 The value shown for A4's frequency assumes that the scale is set to Equal Temperament. If a different scale is selected, the actual frequency of A4 may be different.

System ID

This number identifies the wavestate to computer hosts. If you have multiple wavestates, set each to a different number.

MIDI & USB



Global Channel

[1...16]

This is the basic MIDI channel for the wavestate. It applies to:

- MIDI sent from the built-in keyboard and controllers (except for Program Mod Knobs)
- MIDI received by any Layer with **Use Global MIDI Channel** enabled
- MIDI CCs received by and sent from the Program Mod Knobs, for any Layer with **Use Global MIDI Channel** enabled
- Program Change (via Set Lists)
- Other global functionality, such as modulation of Master Reverb, Vector Envelope, and System Exclusive

Local Control

[Off, On]

On: This is the default; the wavestate's internal sounds will be played by the built-in keyboard and controllers. If you are playing the wavestate by itself, leave this setting checked.

Off: The wavestate's keyboard and controllers, including the Mod Knobs, will be disconnected from the internal sounds. MIDI transmit and receive will continue to work normally. Use this setting if loop-back from an external sequencer causes duplicate notes.

Clock

[Internal, External, Auto]

Internal: The wavestate will use the Performance's Tempo setting (also shown and controlled by the **TAP TEMPO** button). Use this when playing the wavestate by itself, or when you want the wavestate to control the tempo of external MIDI devices such as a sequencer or drum machine.

External: The wavestate tempo will synchronize to incoming MIDI Clock messages from either 5-pin MIDI or USB. If MIDI clocks are not being received, tempo-related features will not function.

Auto: This combines the functionality of *Internal* and *External*, so that you don't have to manually switch between the two:

- If MIDI Clocks are not being received, the wavestate uses its internal tempo.
- If MIDI Clocks are being received, they control the tempo. If the clocks stop for more than 500 ms, the wavestate switches back to internal tempo.

USB Network

[RNDIS, NCM]

The wavestate uses USB networking to communicate with the Editor Librarian and Updater software on MacOS and Windows computers. This selects the network protocol which will be used. Some computer operating systems may require one setting or the other; for the latest information, please see the documentation included with the Editor Librarian or Updater.

 Changes to this parameter take effect only after the wavestate has been turned off and restarted.

RNDIS: This is the RNDIS protocol, recommended for use with Windows 7 and 8.

NCM: This is the Network Control Model protocol, recommended for use with MacOS and Windows 10 and later.

Controllers

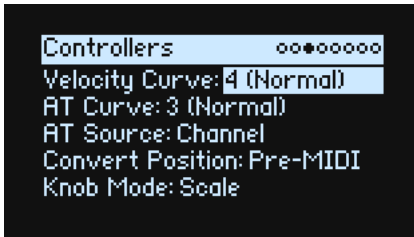

Velocity Curve

[1 (Heavy), 2, 3, 4 (Normal), 5, 6, 7, 8 (Light), 9 (Wide)]

This controls how the volume and/or tone responds to variations in keyboard playing dynamics (velocity). Choose the curve that is most appropriate for your playing strength and style.

Velocity Curves always work the same way between the built-in keyboard and the synth engine. The way that they relate to MIDI, however, is tied to the **Convert Position** setting (see below).

Velocity curves

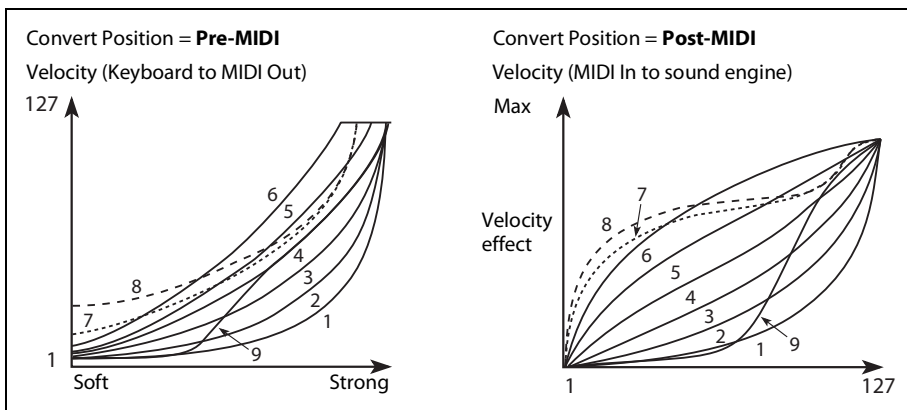

1 (Heavy), 2, 3: These are for heavy playing; most of the variation occurs in the upper velocity range.

4 (Normal): This is the default.

5, 6: These are for lighter playing.

7: This is for very light playing, at the expense of control in the middle of the range.

8 (Light): This curve produces the most uniform output, for when velocity sensitivity is not desired.

9 (Wide): This curve is designed for the heavier touch of external weighted keyboards.

AT Curve (Aftertouch Curve)

[1 (Heavy), 2, 3 (Normal), 4, 5 (Light), 6 (24-step), 7 (12-step), 8 (Random)]

This controls how the sounds respond to variations in pressure applied to the keyboard while playing a note (aftertouch). Choose the curve that is most appropriate for your playing strength and style. All wavestate models support aftertouch via MIDI; the wavestate SE also generates aftertouch from its built-in keyboard.

Aftertouch Curves always work the same way between the wavestate SE's built-in keyboard and the synth engine. The way that they relate to MIDI, however, is tied to the **Convert Position** setting (see below).

Utility

Aftertouch curves

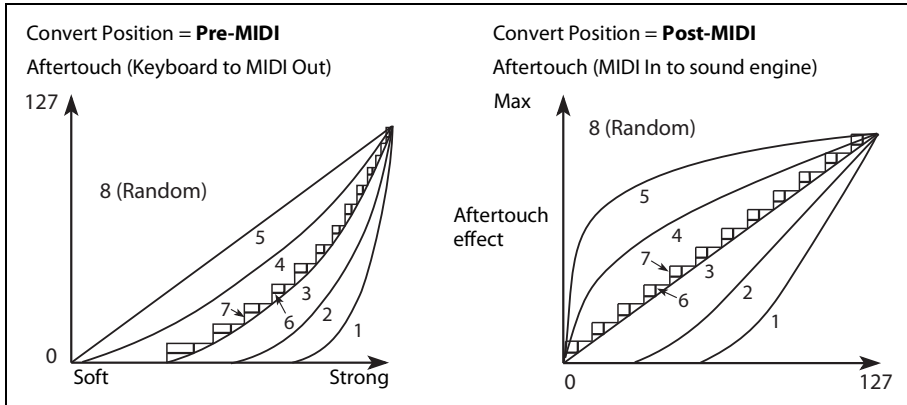

1 (Heavy), 2: These are for heavy playing; most of the variation occurs with stronger pressure.

3 (Normal): This is the default.

4, 5 (Light): These produce changes even with light pressure.

6 (24-step), 7 (12-step): These curves result in 24 or 12 steps, respectively. If Aftertouch is modulating pitch with an intensity of one octave, 7 (12-step) lets you use Aftertouch to play a chromatic scale. (For similar results, you could also use a Mod Processor set to Quantize.)

8 (Random): This is a random curve. Use this to create special effects, or for applying unpredictable modulation.

wavestate SE aftertouch calibration

The wavestate SE's aftertouch mechanism is calibrated at the factory, and in general should not require further adjustment. It can, however, be re-calibrated if necessary. To do so:

1. Go to the **Controllers page**, under **UTILITY**.
2. Press and hold the **UTILITY** button.
3. While continuing to hold **UTILITY**, press the **<** button.

The Aftertouch Calibration screen will appear. Follow the on-screen instructions.

AT Source (Aftertouch Source)

[Off, Channel, Poly, Chan+Poly]

This lets you instantly re-configure the synth to take advantage of controllers with Poly Aftertouch.

Important: to use the wavestate SE's built-in aftertouch, make sure to set **AT Source** to either *Channel* or *Chan + Poly*.

Off: All aftertouch will be ignored, including the wavestate SE's built-in aftertouch.

Channel: The mod source "Aftertouch" receives Channel Aftertouch. Poly Aftertouch can still be used via the dedicated Poly AT mod source.

Poly: The mod source "Aftertouch" receives Poly Aftertouch. Channel Aftertouch is ignored.

Chan+Poly: The mod source "Aftertouch" receives both Channel and Poly Aftertouch. If both are sent simultaneously, the most recent value is used.

Convert Position

[Pre-MIDI, Post-MIDI]

This setting controls how the **Transpose**, **Velocity Curve**, and **Aftertouch Curve** settings work. (Note that **Aftertouch Curve** appears only on the wavestate SE.) You can think of these as a set of MIDI effects processors, which can be used in one of two places within the wavestate.

Note: Regardless of the **Convert Position**, **Transpose** and **Velocity/Aftertouch Curves** always apply when playing internal sounds directly from the wavestate keyboard.

Pre-MIDI: This is the default. **Transpose** and **Velocity/Aftertouch Curves** affect MIDI *output*.

Utility

Convert Position = Pre-MIDI

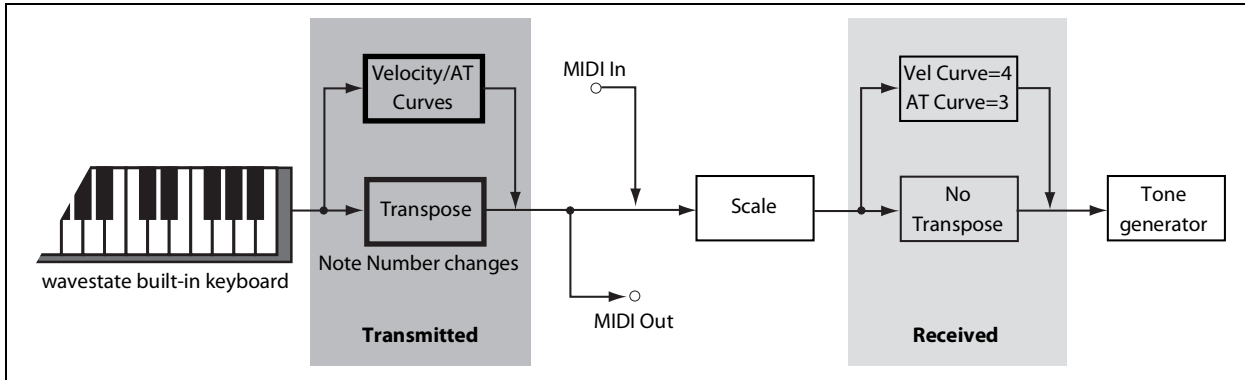

Post-MIDI: **Transpose** and **Velocity/Aftertouch Curves** affect MIDI *input*. Use this to adjust response to an external MIDI controller.

Post-MIDI also shifts Global and Performance Scales to match the **Transpose** setting—convenient for use with non-equal-tempered scales. See also “Transpose” on page 89.

Convert Position = Post-MIDI

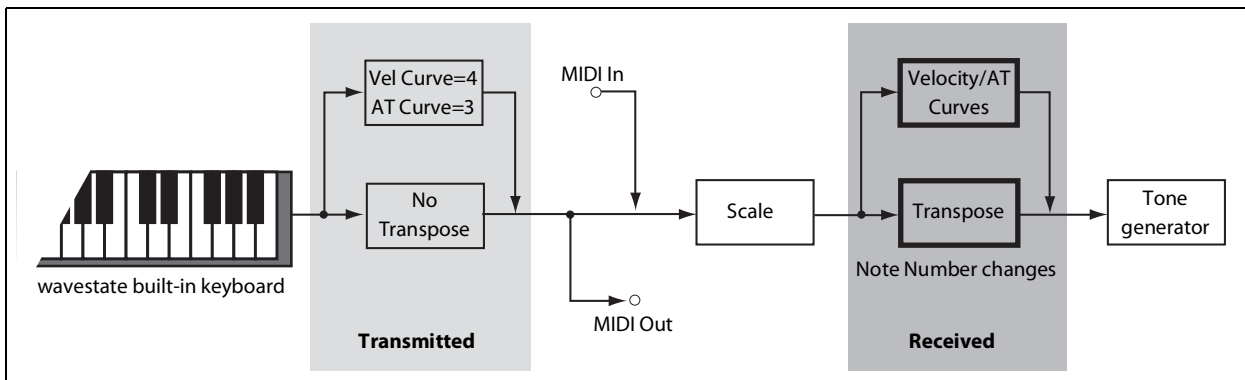

Knob Mode

[Scale, Jump]

When you switch to a new Performance or select a different Layer, Wave Sequence Lane, Effect, Envelope, LFO, etc., the parameter values “underneath” the front-panel knobs will change—but the physical knobs won’t move automatically. **Knob Mode** controls what happens when you move a knob.

Scale: This is the default. The physical position of the knob is mapped to the current parameter value. Moving the knob counter-clockwise goes from the current value to the minimum; moving clockwise goes from the current value to the maximum. If you turn the knob all the way to the left or right, the range is reset. See the graphic below.

Jump: When a knob is moved, the parameter value instantly changes to match the position of the knob.

Knob Mode set to Scale

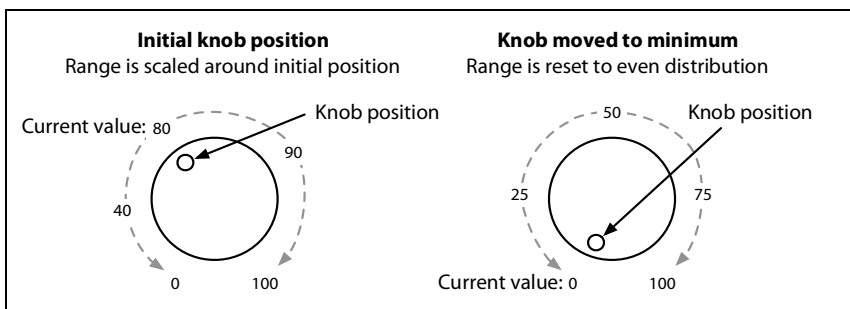

MIDI CC Assign

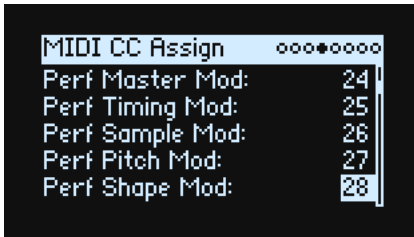

You can control Scale Select and each Mod Knob directly from MIDI CCs. These CCs edit the assigned parameters, just like moving the front-panel knobs. To modulate a parameter with variable intensity, and without causing edits to the sound, use modulation instead. Some dedicated CCs cannot be assigned (CCs 1, 7, etc.).

Use **ENTER** + cursor (< or >) to jump forward or back by five parameters at a time.

Function	Default CC assignment
Scale Select	9
Performance Mod Knobs 1...8	24...31
Layer A Mod Knobs 1...8	80...87
Layer B Mod Knobs 1...8	88...95
Layer C Mod Knobs 1...8	102...109
Layer D Mod Knobs 1-8	110...117

Global Scale

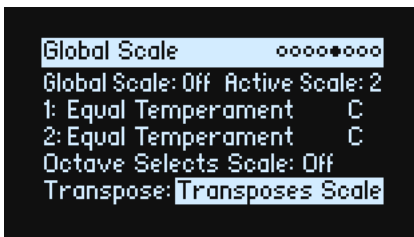

Global Scale

[Off, On]

On: The settings on this page control the instrument's scales. Performance scales are ignored.

Off: The scale settings on this page are ignored.

Note: If both **Global Scale** and **Performance Scale** are *Off*, the system simply uses equal temperament.

Active Scale

[1, 2]

If **Global Scale** is *On*, this chooses which of the two scales below is used. You can control this via MIDI. See also "Octave Selects Scale," below.

1 (Scale 1)

[Arabic, Equal Temperament, Kirnberger, Pelog, Pure Major, Pure Minor, Pythagoras, Slendro, Stretch, Werkmeister]

This selects the first scale to be used. You can load and edit Scales using the Editor/Librarian application for macOS and Windows; for more information, see the Editor/Librarian manual.

Some of the factory Scales are described below.

Arabic: This includes the quarter-tone intervals used in Arabic music.

Utility

Pythagoras: Especially effective for melodies, this produces 11 completely pure fifths, at the expense of other intervals—thirds in particular. To maintain the tuning of the octave, the final fifth—from sharp four to sharp root—is also quite flat.

Werkmeister (Werkmeister III), Kirnberger (Kirnberger III): These are “Well-Tempered” tunings from the Baroque period.

Pelog: This Indonesian gamelan scale uses seven notes per octave. When **Key** is set to C, use the white keys. The black keys will play the equal tempered pitches.

Pure Major, Pure Minor: These are Just Intonations optimized for major and minor keys, respectively. Unlike the other scales, they maintain the A4 tuning (e.g. A=440 Hz) as set by the Global **Tune** parameter (see “Tune” on page 83). Because of this, the root note of the selected **Key** may shift from its equal-tempered pitch.

Slendro: This Indonesian gamelan scale has five notes per octave. When **Key** is set to C, use C, D, F, G and A. Other notes will play the normal equal-tempered pitches.

Stretch: In this acoustic piano tuning, notes below the middle of the keyboard are progressively more flat, and notes above the middle are progressively more sharp.

(Key)

[C...B]

This controls the root key of the Scale. **Key** applies only if the **Scale Type** is *Octave Scale* or *Octave Scale, A=Master Tune*. If the **Type** is *128 Note Scale*, **Key** is ignored. For more information, see the Editor/Librarian manual.

Note: Specific combinations of **Scale** and **Key** may skew the reference tuning pitch. For example, A4 might become 442 Hz, instead of 440 Hz. Use **Master Tune** to correct this, if necessary. Alternatively, when tuning to A, use the *Octave Scale, A=Master Tune Scale Type*.

2 (Scale 2)

(Key)

These are the second **Scale** and its associated **Key**.

Octave Selects Scale

[Off, On]

If this is *On*, the **OCTAVE** down button selects Scale 1, and **OCTAVE** up selects Scale 2 (for either the Global or Performance scale, depending on which is in use). **SHIFT+OCTAVE** then performs octave up/down functionality.

 The wavestate module does not have front-panel **OCTAVE** buttons.

Transpose

[Transposes Scale, Within Scale]

This parameter determines how the Performance and Program **Transpose** parameters interact with the Scale and Key. *Within Scale* means that transposition uses intervals within the current scale. This option works well if you are using non-equal-tempered scales and want to build parallel intervals (such as “fat fifths”) into your sounds. For example, let’s say that you are using Just Intonation in the key of C. If you transpose one of the Programs up by 7 semitones and play a C, the result will be two notes: C, and G 2 cents sharp (the Just Intonation fifth).

Transposes Scale means that the Scale’s Key changes to match the transposition. This option is useful if you play in non-equal-tempered scales and transpose entire songs—to accommodate singers, for example. In other words, let’s say that the **Key** is set to C, and the third note of the scale (E) is 50 cents flat. If you transpose up by 2 semitones, and play an E, the result will be an F# 50 cents flat—still the third note of the scale. For this application, it’s also best to set the **Convert Position** to *Post-MIDI*; for more information, see “Chan+Poly: The mod source “Aftertouch” receives both Channel and Poly Aftertouch. If both are sent simultaneously, the most recent value is used.” on page 86.

Preferences

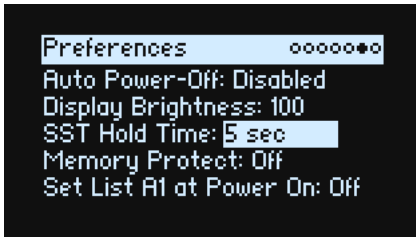

Auto Power-Off

[Disabled, 4 Hours]

By default, to conserve energy, the wavestate will automatically turn off after about four hours have elapsed without use of the front panel, keyboard, or MIDI input, and without being connected to the Editor/Librarian. You can disable this feature, if desired.

- ⚠ When the power turns off, any un-saved edits or settings will be lost. Make sure that you save important settings before this occurs.

Display Brightness

[0...100]

This controls the brightness of the OLED display.

SST Hold Time

[0 ms...60 sec]

This controls the duration of Smooth Sound Transitions. It sets how long reverbs, delays, and note releases continue to ring out after a new sound has been selected. The timer starts after all notes from the previous sound are no longer being held down, and the sustain pedal is released.

Memory Protect

[Off, On]

When this is *On*, Write functionality is disabled.

Set List A1 at Power On

[Off, On]

Off: At power-up, the last-used sound will be selected.

On: At power-up, Set List Slot A1 will be selected.

System Stats

This page provides diagnostic information for the system.

CPU Usage

[0.00...100.00%]

This shows the percentage of available processing power being used for voices and effects.

Temperature

[°C]

This shows the CPU's temperature.

Sounding Voices

[wavestate: 0...64; wavestate mkII: 0...96; wavestate SE and module: 0...120]

This shows the number of voices currently being played. Wave Sequences use two voices per note, so if all four Layers are active, a single note may trigger up to 8 voices.

Utility

Voice Stealing

[wavestate: 0...64; wavestate mkl: 0...96; wavestate SE and module: 0...120]

Sometimes, if a lot of voices are already sounding, there won't be enough free power to play a new voice. When this happens, the system stops older or lower-priority voices so that the CPU can be used for the new voice instead. This is called "voice stealing." This shows the amount of voice stealing, in real time.

Available Storage

[size in MB/GB]

This shows the amount of free space available for storing sound data, including user samples and Performances, Programs, etc.

About

This page shows the software version number and abbreviated credits. The wavestate is the result of a team effort, built through the talents of many more people than can be listed on-screen!

USB

You can connect the wavestate to computers via USB to send and receive MIDI, edit and organize sound data with the wavestate Editor/Librarian, and edit and organize sample data with the Korg Sample Builder.

MIDI

The wavestate is a class-compliant USB MIDI device, and requires no driver for MIDI functionality.

Editor/Librarian and Korg Sample Builder

The wavestate Editor Librarian and Korg Sample Builder applications support macOS and Windows, and are available as downloads from www.korg.com. For more information, please see the documentation included with the applications.

Specifications

System

Keyboard:

wavestate and wavestate mkII: 37 keys, velocity and release-velocity sensitive

wavestate SE: 61 keys, Natural Touch keyboard, velocity and release-velocity sensitive, with aftertouch

Maximum Polyphony:

wavestate: 64 stereo voices

wavestate mkII: 96 stereo voices

wavestate SE and wavestate module: 120 stereo voices

Sound generating system: Wave Sequencing 2.0

Modulation

Controllers: Mod Wheel, Pitch Wheel, Vector Joystick, 8x Mod Knobs

Other Sources: 3x ADSR Envelopes, Vector Envelope, 4x LFOs, 2x Mod Processors, 2x Key Track, Step Seq Lane, Step Pulse, Tempo, Program/Performance Note Count, Program/Performance Voice Count, Poly Legato, Velocity, Exponential Velocity, Release Velocity, Gate, Gate+Damper, Note-On Trigger, Note-On Trigger+Damper, Note Number, Aftertouch (wavestate: external MIDI only), Poly Aftertouch (external MIDI only), MIDI CCs +/-, MIDI CCs +

Destinations: Most parameters can be modulated, including parameters of individual Wave Sequence Steps. Depending on Wave Sequence length, there can be more than 1,000 potential modulation targets per Program.

Effects

Pre FX: Decimator, Graphic EQ, Guitar Amp, Modern Compressor, Parametric EQ, Red Compressor, Ring Modulator, Tremolo, Wave Shaper

Mod FX: Black Chorus/Flanger, Black Phase, CX-3 Vibrato Chorus, EP Chorus, Harmonic Chorus, Modern Chorus, Modern Phaser, Orange Phase, Orange Phase V2, Polysix Ensemble, Small Phase, Talking Modulator, Vintage Chorus, Vintage Flanger, Vintage/Custom Wah, Vox Wah

Delay: L/C/R Delay, Multiband Mod Delay, Reverse Delay, Stereo/Cross Delay, Tape Echo

Master Reverb: Early Reflections, Overb

Master EQ: 4-band parametric EQ

General

Inputs/outputs: Headphone (6.3 mm stereo phone jack), OUTPUT L/MONO and R (impedance-balanced 6.3 mm TRS phone jacks), DAMPER (6.3 mm phone jack, half-damper not supported), MIDI IN and OUT connectors, USB B port

Power supply: AC adapter (DC12V, 2500mA)

Power consumption: 5 W

Dimensions (W × D × H):

wavestate and wavestate mkII: 565 × 338 × 92 mm/22.24" × 13.31" × 3.62"

wavestate SE: 1,014 × 344 × 110 mm/39.92" × 13.54" × 4.33"

wavestate module: 483 × 172 × 113 mm/19.02" × 6.77" × 4.45"

Weight: wavestate and wavestate mkII: 2.9 kg/6.93 lb; wavestate SE: 8.6 kg/18.96 lb; wavestate module: 1.7 kg/3.75 lb

Included items: AC adapter, Precautions, Quick Start Guide

Accessories (sold separately): DS-1H damper pedal, PS-1 pedal switch, PS-3 pedal switch

* Specifications and appearance are subject to change without notice.

* All product names and company names are the trademarks or registered trademarks of their respective owners.

Model: wavestate MIDI implementation chart

Function		Transmitted	Recognized	Remarks
Basic Channel	Default	1–16	1–16	Memorized
	Changed	1–16	1–16	
Mode	Default		3	
	Messages	X	X	
	Altered	*****		
Note Number		0–127	0–127	Some sounds will not play across the entire note range
	True Voice	*****	0–127	
Velocity	Note On	O 9n, V=1–127	O 9n, V=1–127	Received Note Off Velocity values are clipped at 64
	Note Off	O 8n, V=1–64	O 8n, V=0–127	
After Touch	Polyphonic (Key)	X	O	Aftertouch transmit: wavestate SE only
	Channel	O	O	
Pitch Bend		O	O	
Control Change	1	O	O	Modulation
	7	X	O	Volume
	10	X	O	Pan
	11	X	O	Expression
	16, 17	O	O	Vector JSX, Y
	64	O	O	Damper
	66	X	O	Sostenuto
	67	X	O	Soft
2-6, 8-9, 12-31, 32-63, 65, 67-95, 102-119	O	O	Assignable for controllers and modulation *1	
120, 121	X	O	All Sounds Off, Reset All Controllers	
Program Change		O 1–64	O 1–64	Selects Slots in the current Set List
	True Number	*****	0–63	
System Exclusive		O	O	*2
System Common	Song Position	X	X	
	Song Select	X	X	
	Tune Request	X	X	
System Real Time	Clock	O	O	
	Commands	X	X	
Aux Messages	Local On/Off	X	X	
	All Notes Off	X	O 123–127	
	Active Sense	O	O	
	System Reset	X	X	

Notes *1: Sent and received by Mod Knobs and Scale Select when assigned in UTILITY > MIDI CC Assign; also received as programmable modulation sources
 *2: Supports universal system exclusive messages device inquiry, master volume, master fine tuning, and master coarse tuning

Mode 1: Omni On, Poly Mode 2: Omni On, Mono O: Yes
 Mode 3: Omni Off, Poly Mode 4: Omni Off, Mono X: No

Consult your local Korg distributor for more information on the MIDI implementation.

KORG INC.

4015-2 Yanokuchi, Inagi-City, Tokyo 206-0812 JAPAN

© 2020 KORG INC.

www.korg.com
Published 03/2024