

∅-∅AST

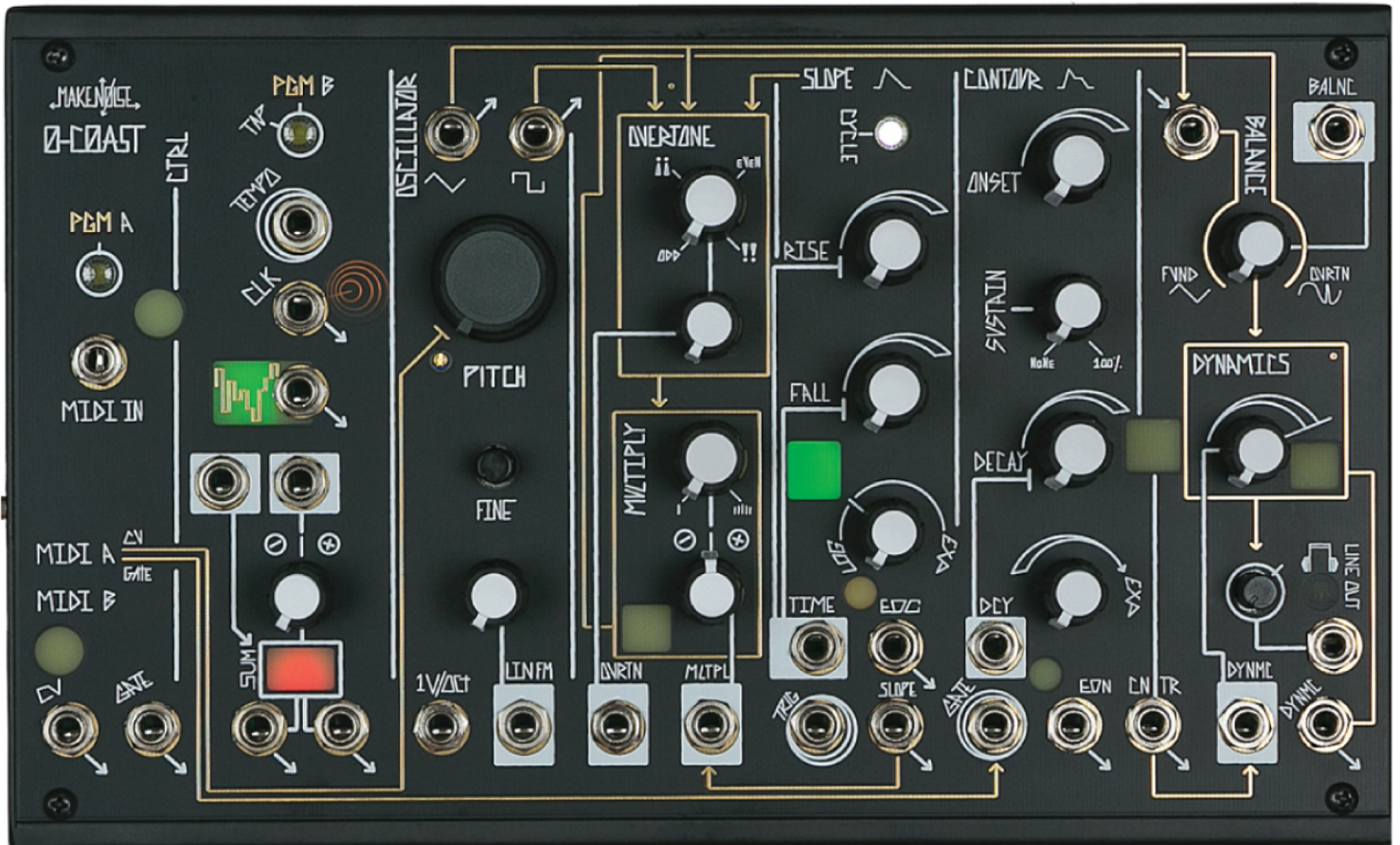

MAKE NOISE

v. 3.8

Limited Warranty -----	3
Overview -----	4
Patch Notations -----	5
User Interface -----	6
Panel Controls -----	7
Default Sounds -----	8
Getting Started:	
Power Up -----	9
MIDI and CV/Gate Controllers -----	10
MIDI Program Pages -----	11-13
Accessing Program Page Functions via MIDI CC -----	14
Circuits that Create, Modify, and Modulate the Sound -----	15
MIDI B , MIDI Controlled Arpeggiator -----	16
Signals -----	17
Attenuation -----	18
Attenuversion -----	19
Control Voltage: Range-----	20
The Voice: The Oscillator-----	21
The Timbre:	
OVERTONE & MULTIPLY -----	22
Modulating with SLOPE -----	23
Balance -----	24
The Magnitude:	
Amplitude and Brightness -----	25
Level -----	28
Beyond the Default Sound:-----	29
Open Patch Points -----	30-32
Overriding Normals -----	33
Voltage Math -----	34
Using the 0-Coast with other devices -----	35
Patch Ideas -----	36-39
??? -----	43
MIDI Cable Pin Out -----	44



This device complies with Part 15 of the FCC Rules. Operation is subject to the following two conditions: (1) this device may not cause harmful interference, and (2) this device must accept any interference received, including interference that may cause undesired operation.

Changes / modifications not approved by the Make Noise Co. could void the user's authority to operate the equipment.

This equipment has been tested and found to comply with the limits for a Class A digital device, pursuant to part 15 of the FCC Rules. These limits are designed to provide reasonable protection against harmful interference when the equipment is operated in a commercial environment. This equipment generates, uses, and can radiate radio frequency energy and, if not installed and used in accordance with the instruction manual, may cause harmful interference to radio communications.

makenoisemusic.com

Make Noise Co., 414 Haywood Road, Asheville, NC 28806

Limited WARRANTY:

Make Noise warrants this product to be free of defects in materials or construction for a period of one year from the date of purchase (proof of purchase/invoice required).

Malfunction resulting from wrong power supply voltages, backwards or reversed eurorack bus board cable connection, abuse of the product, removing knobs, changing face plates, or any other causes determined by Make Noise to be the fault of the user are not covered by this warranty, and normal service rates will apply.

During the warranty period, any defective products will be repaired or replaced, at the option of Make Noise, on a return-to-Make Noise basis with the customer paying the transit cost to Make Noise.

Make Noise implies and accepts no responsibility for harm to person or apparatus caused through operation of this product.

Please contact technical@makenoisemusic.com with any questions, Return To Manufacturer Authorization, or any needs & comments.

<http://www.makenoisemusic.com>



About This Manual:

Written by Tony Rolando and Walker Farrell
Illustrated by W.Lee Coleman

The 0-COAST is a single voice patchable synthesizer. It's name reflects the fact that it utilizes techniques from both the Moog and Buchla paradigms (aka "East Coast," and "West Coast," due to their locations), but is loyal to neither and thus implements "no coast synthesis."

While the 0-COAST utilizes classic modular synthesis techniques, we designed it to operate with or without the use of patch cables. The necessary connections have been made from circuit to circuit (**Fig. 1**) so it operates as an expressive, musical MonoSynth. Using only the MIDI controller of your choice you could apply new timbres to your existing musical forms! Using the included Patch Cables you could get more scientific, experimenting with new ways to wire up the circuits. You might even forgo MIDI altogether, disappearing into a cloud of analog FM induced Sidebands and harmonics scattered around a single fundamental drone that has nothing to do with any form of music you've ever known!

Figure 1: Normalizations

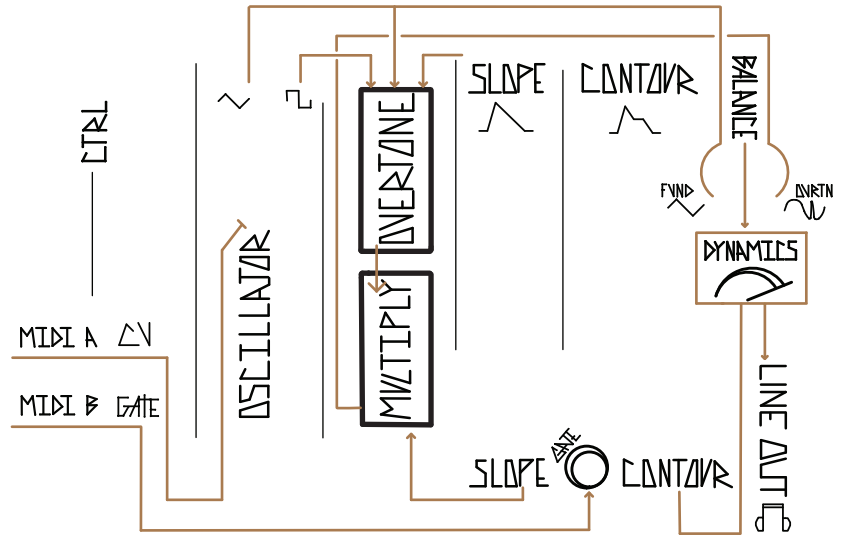

The second half of this manual travels deeper into the operation of the 0-COAST, teaching you how to override the internal signal routing using Patch Cables so that you may create new variations of the MonoSynth, experiment with drones, and allow the 0-COAST to converse with other analog synthesis circuits, modular synths, and more.

In this manual, patch instructions will be notated like this (the  represents a patch cable connected to the two jacks):



For example:



As you may have guessed, this is instructing you to patch the Square Wave Output from the 0-Coast's **Oscillator** Circuit to the External Input of the Balance Circuit. Don't worry if it sounds daunting, you'll quickly get the hang of it. Accompanying the written patch instructions, you'll also find small, visual representations of the connections. Continuing the example above:

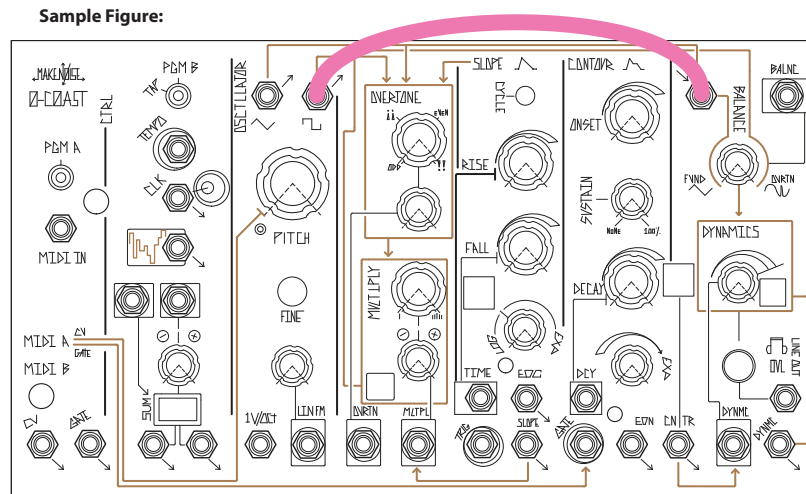

SCOPE NOTATIONS :



In this manual, patch examples are sometimes shown with an illustration that resembles the signal(s) as displayed on an oscilloscope. These drawings are for diagrammatic and/or conceptual purposes only and not intended for laboratory use. **Scope diagrams are not to scale.**

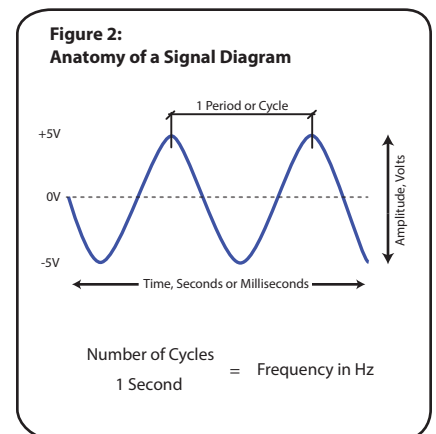

Panel Controls:

The knobs on any particular module are utilized to set values for their respective parameters. Often a value can be altered by **Control Voltage (CV)** in an input jack, which can be visualized as an invisible hand "turning" the knob. We will go into much more detail about CV, which is in many ways the defining characteristic of the modular synthesizer.

The medium (white) knobs and large (grey) knobs are generally used for setting base values, while small (white) knobs are used to **Attenuate** (i.e. "scale") and/or **Invert** incoming CV.

Figure 3:

Common knobs shown with associated patch notation, when applicable.

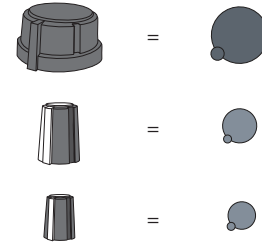

Illuminated Buttons and Activity Windows:

The 0-Coast utilizes Buttons for certain functions and behaviors <light> or <flash> to indicate a variety of behaviors and conditions. Perhaps the most common use is the <flashing red> Activity Window that shows the Clock Rate; however, Activity Windows may also display signal amplitude and polarity, MIDI Activity, or indicate alternate modes, for instance, Self-Cycle.

Figure 4: Typ. Illuminated Button and Activity Window



Jacks:

Every jack in the 0-Coast is either an input or an output. Jacks are patched together with cables. Simply plug one end of the cable into an input and the other end into an output. Patching an input to another input has no effect, patching an output to another output has unpredictable effects and is generally not recommended. Don't worry though, you won't hurt anything by patching "incorrectly," so don't be afraid of happy accidents...

Figure 5: Typical Jack Labels:

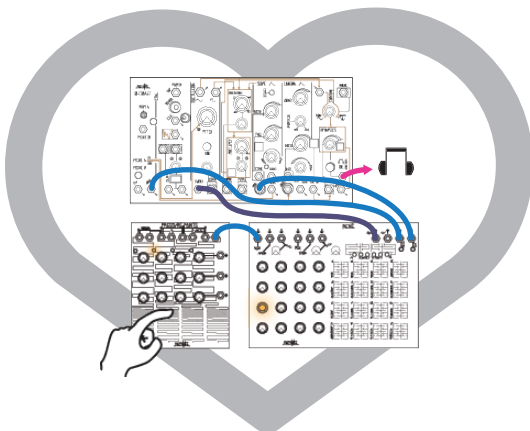

External CV (Control Voltage):

Because the 0-Coast works within the same voltage requirements as Eurorack modules, the 0-Coast excels when paired with an analog synthesizer, such as the Make Noise Shared System (sold separately). As always, Experimentation is paramount.

Normalizations:

The 0-Coast often takes advantage of the switching jack behavior such that when nothing is patched, a Normalization, or pre-wired patch connection, exists between circuits. For instance, the SLOPE CV Output is Normalized to the Multiply CV Input for pre-configured modulation of Timbre.

Figure 6: Typ. Normalization Label

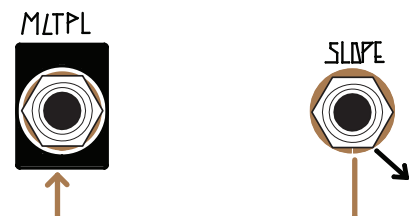
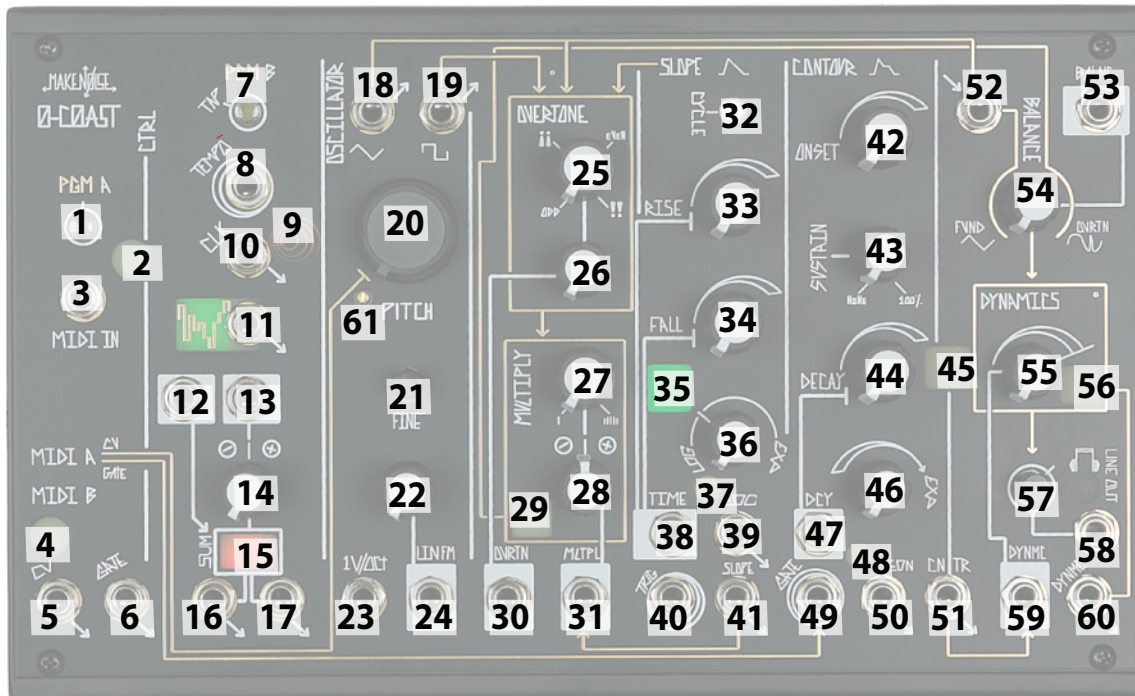

Figure 7: Panel Controls



- | | |
|---|---|
| <ol style="list-style-type: none"> 1. PGM A Illuminated Button <white> 2. MIDI A Activity Window <red> 3. MIDI Input Jack 4. MIDI B Activity Window <red> 5. Ext. CV Output 6. Ext. Gate Output 7. PGM B Illuminated Button <white> 8. TEMPO Input 9. TEMPO Activity Window <red> 10. CLoCK OUTput 11. Stepped Random OUTput 12. Voltage MATH: Channel 1 Input 13. Voltage MATH: Channel 2 Input 14. Voltage MATH: Channel Attenuverter 15. Voltage MATH: Activity Window <red> / <green> 16. Voltage MATH: Channel 1 Output 17. Voltage MATH: Channel 2 Output 18. Oscillator: Triangle Wave Output 19. Oscillator: Square Wave Output 20. Oscillator: Pitch Panel Control 21. Oscillator: Pitch Fine Tune 22. Oscillator: Linear FM Input Attenuator 23. Oscillator: 1/V OCTave Input* 24. Oscillator: Linear FM Input 25. Overtone: Panel Control 26. Overtone: CV Input Attenuator 27. Multiply Panel Control 28. Multiply: CV Input Attenuverter 29. Multiply: Activity Window <orange> 30. Overtone: CV Input | <ol style="list-style-type: none"> 31. Multiply CV Input 32. Slope: Cycle Illuminated Button <white> 33. Slope: Rise Panel Control 34. Slope: Fall Panel Control 35. Slope: Activity Window <green> 36. Slope: Vari-Response 37. Slope: End of Cycle (EOC) Activity Window <yellow> 38. Slope: Rise/Fall Time CV Input 39. Slope: End of Cycle (EOC) Gate Output 40. Slope: Trigger Input 41. Slope: CV Output 42. Contour: Onset Panel Control 43. Contour: Sustain Panel Control 44. Contour: Decay Panel Control 45. Contour: Activity Window <green> 46. Contour: Vari-Response 47. Contour: Decay Time CV Input 48. Contour: End of Onset (EON) Activity Window <yellow> 49. Contour: Gate Input 50. Contour: End of Onset (EON) Output 51. Contour: CV Output 52. Balance: Channel External Input 53. Balance: CV Input 54. Balance: Attenuator 55. Dynamics: Attenuator 56. Dynamics: Activity Window <orange> 57. Headphone/Line Output: Level Control 58. Headphone/Line Output: TRS Stereo Audio Signal, 3Vpp 59. Dynamics CV Input 60. Dynamics Output: Modular level Audio Signal, 10vpp 61. Oscillator: Calibration Trimmer** |
|---|---|

*This input is designed with analog sequencers in mind, and can be expected to track reasonably well over a 4-octave range. For wider range or more precision in tracking, the MIDI input is preferred.

**Only recommended for analog synth technician. Affects Tuning and MIDI Calibration.

Figure 8: Default Sound

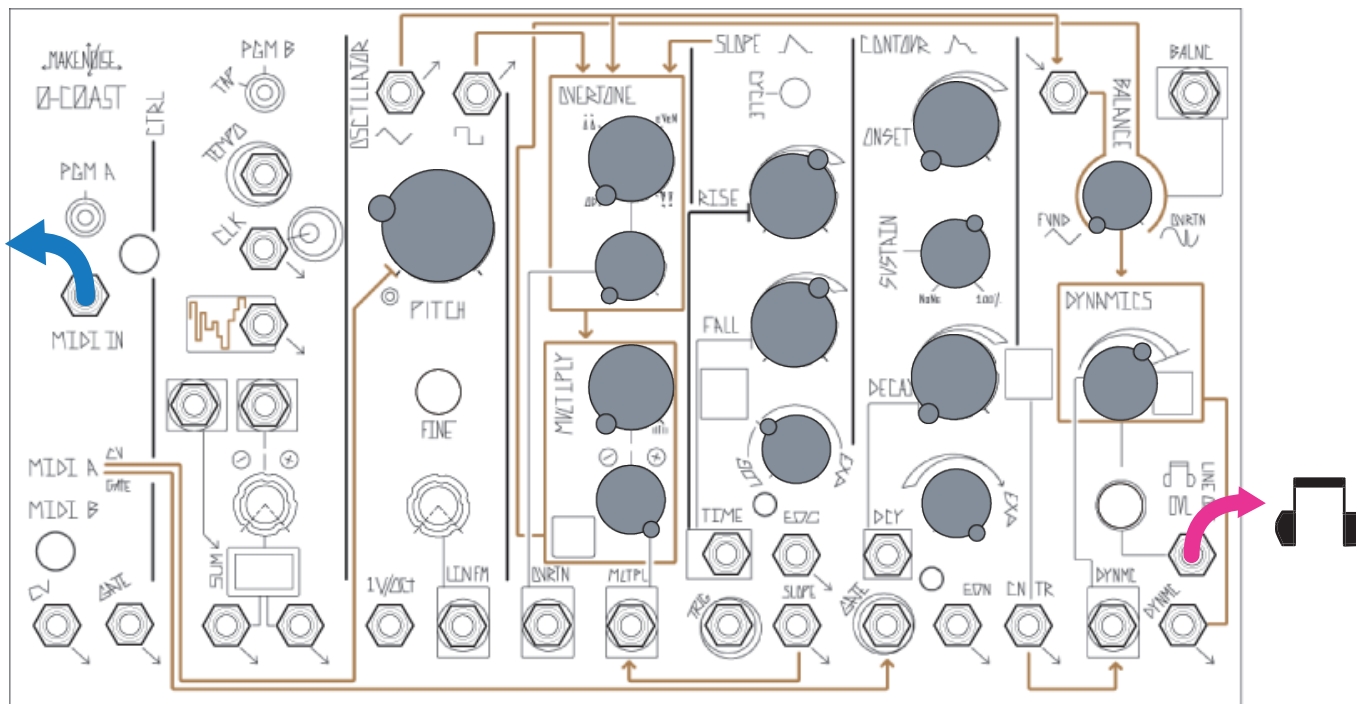

Figure 9: Drone

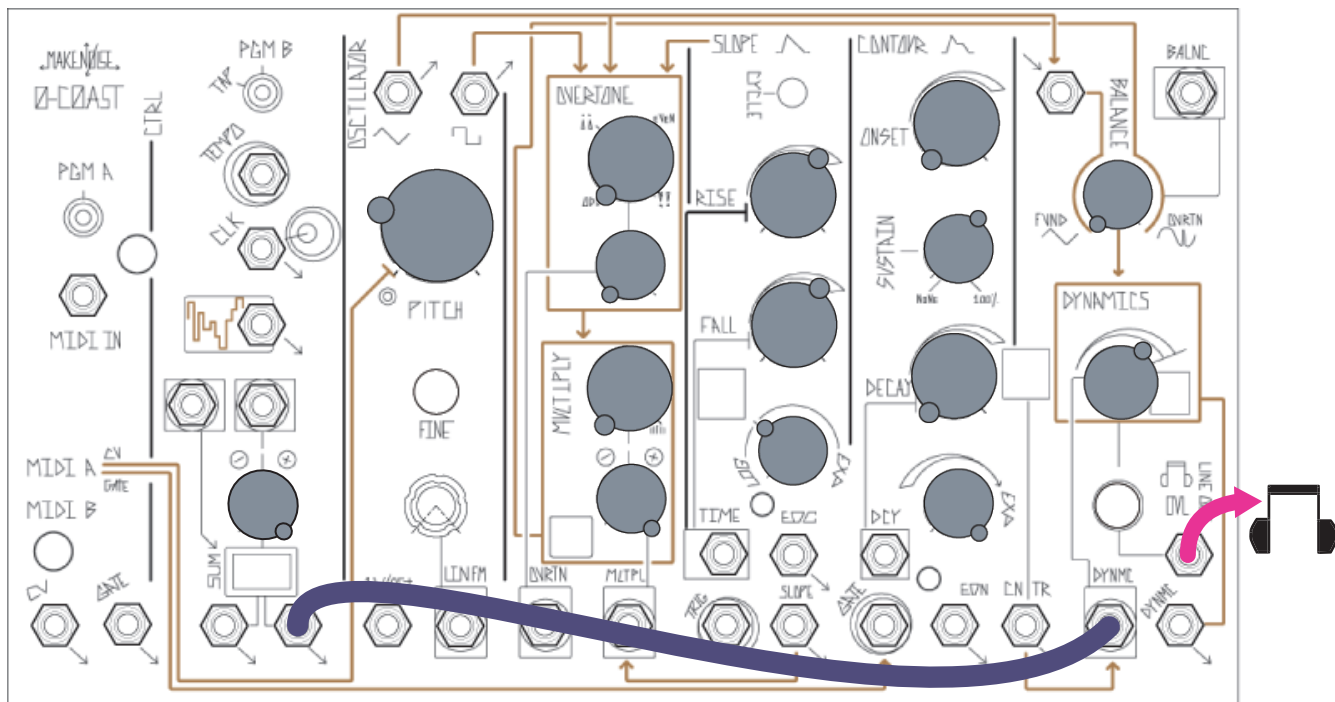
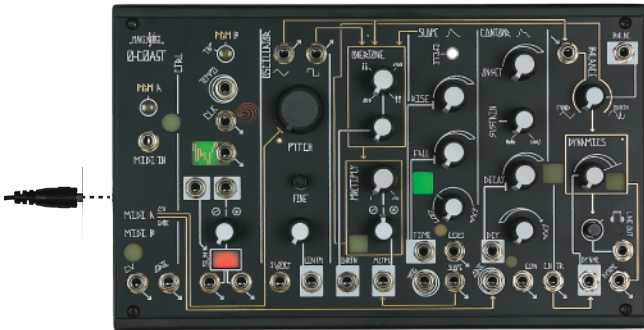

Figure 10: Connecting the Power



It is recommended that the 0-COAST AC adapter is plugged into a fuse-protected power strip with an On/Off switch; however, if that is not available, it is OK to plug it into a wall outlet. Use only the Make Noise 0-COAST 15VDC Tip Positive AC Adapter to power the 0-COAST. To turn on your 0-COAST, once you have the plugged the AC Adapter into your AC outlet, attach the other end of AC adapter to the jack on the side of the 0-COAST (Figure 10).

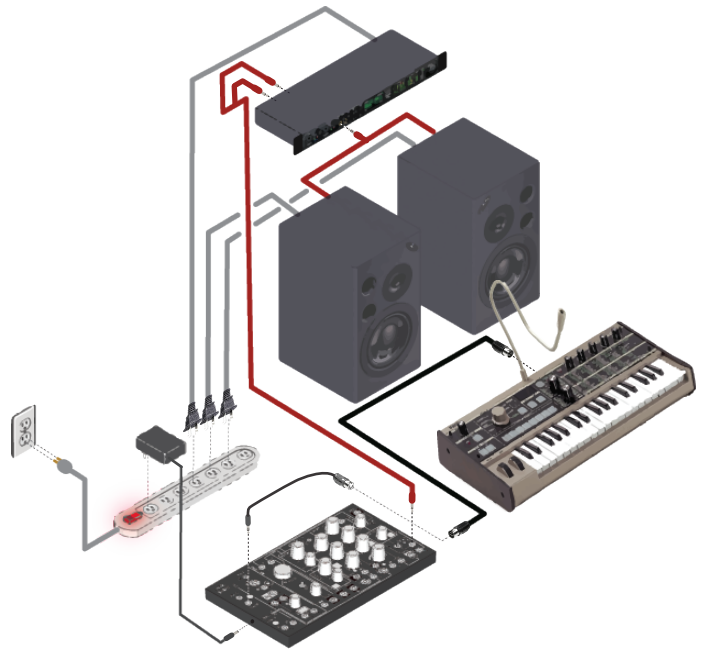

Figure 11: Typical Playback Connections

Always protect your 0-Coast and other equipment by using a fused power strip with power surge protection.

The signals inside the 0-COAST are much higher strength than typical instrument or line-level audio signals. We call these signals “Modular Level.” For example, the OSCILLATOR Triangle Output is a Modular Level output that has an amplitude of about 10 volts peak-to-peak, which is over 4 times “hotter” than that of the typical line-level signal. One reason for this wide difference in amplitude is that not all the signals inside the synthesizer are audio signals. Many of them are Control Voltages which cannot be heard directly, but instead are used to control various elements within the 0-COAST. The higher amplitude outputs of these signals allow them to be used reliably without significant interference from other electronic sources such as computers, appliances, radio waves, etc. Most importantly;

however, **high amplitude signals allow for modulation across the entire range of any parameter.**

e.g.: **Line Output** → **Monitor**

Figure 12: Typical Output Connection

Always use the Line Output when monitoring with headphones or speakers, as it is the only Stereo TRS output jack. Patching directly from the DYNMC Output to headphones or speakers sends a loud, potentially damaging, Mono signal to one of the speakers, while the other speaker remains silent.

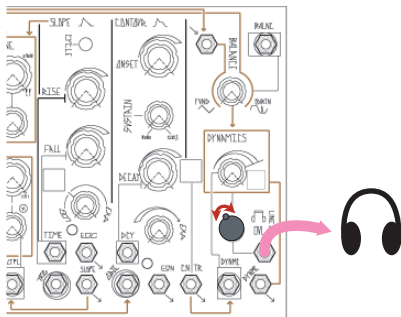

These very hot/loud output signals are quite capable of damaging speakers or ears if not attenuated carefully before monitoring. Whenever connecting any output from the 0-COAST to your mixer, speaker system, amplifier, or headphones, it is recommended that you always start with the volume at zero and bring it up gradually in order to avoid any damage.

The 0-COAST has a dedicated stereo Line Output with a Stereo Mini-Jack and a level control that outputs at typical line level, making monitoring simple, **Figure 12. The Line Output is the only output we recommend plugging into your audio monitoring system.**

NOTE: If connecting the 0-Coast to a mixer or interface with Balanced inputs, use a TS (mono) cable (Fig. 13).

Once powered up, set all Panel Controls to “Default Sound” positions as indicated in **Figure 8 on Page 9**.

For MIDI control, use the included MIDI Adapter to plug your MIDI controller or sequencer to the MIDI Input on the 0-COAST (**Figure 13**). The 0-COAST defaults to receiving MIDI on ALL Channels, so you should be able to strike any key or start a sequence on your MIDI controller and see the MIDI Activity window <flash red> and hear a smooth, simple sound. If you do not hear sound but you see the MIDI Activity windows lighting, please check your monitoring system and the “Default Sound” to ensure that it is setup correctly. If you do not see the MIDI Activity Windows light <Red>, check the setup of your MIDI controller. It should be set to transmit on at least one channel, and the cable should be attached to the MIDI OUT on the controller and MIDI INput on the 0-COAST.

A MIDI controller also allows for use of the On Board Arpeggiator. To Turn on the Arpeggiator [**PRESS**] **PGM_A** and **PGM_B**. **PGM_B** will <light> to indicate Arpeggiator ON. The Default Arp behavior is such that you just [**HOLD**] Keys and they are played in the order played until a key is released at which point, that note is no longer played. Set the Rate of Arpeggiation by [**Tapping**] **PGM_B**. To turn off the Arp, [**PRESS**] both **PGM_A** and **PGM_B**. The **PGM_B** will no longer be lighted and the ARP will stop. For more information, see the **MIDI Programming Quick Reference** section at bottom of page or at the bottom of the unit.

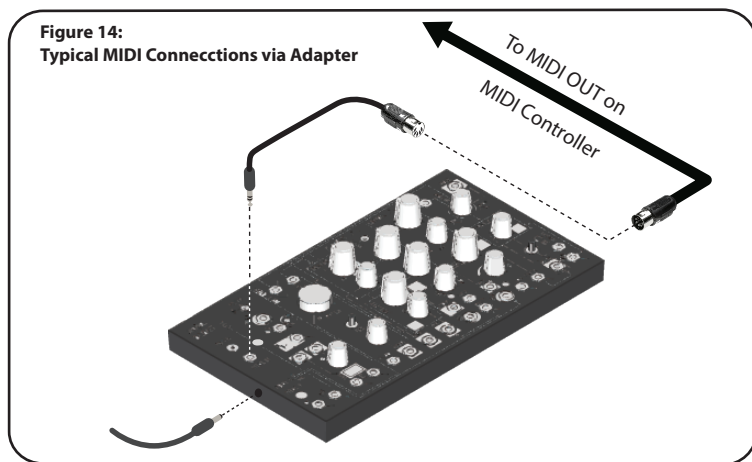
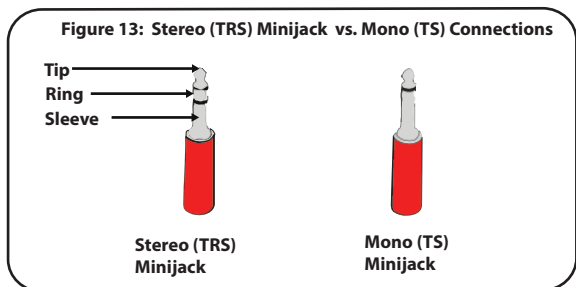

If you will be using a CV/Gate controller, locate the Pitch CV and Gate CV OUTputs on this device. Connect the Pitch CV Output from the controller to the 1V/Octave INput on the 0-COAST and connect the Controller’s Gate Output to the CONTOUR GATE Input, as shown in **Figure 16**. Strike any key or start a sequence on your CV/Gate Controller. You should see visual indication of the GATE OUT. You should hear a smooth, simple sound. If you do not hear sound, but you see the CONTOUR and DYNAMICS Activity window lighting, please check your monitoring system is setup correctly. If you do not see the CONTOUR Activity Window lighting, check that you have the GATE Output from your controller turned on, programmed correctly, and patched to the CONTOUR GATE Input, as in **Figure 16**. If you see only the CONTOUR Function window lighting, and not the DYNAMICS Activity Window, check that you have the DYNAMIC Panel control set to at least 3 o’clock and also make sure the “Default Sound” is properly set.

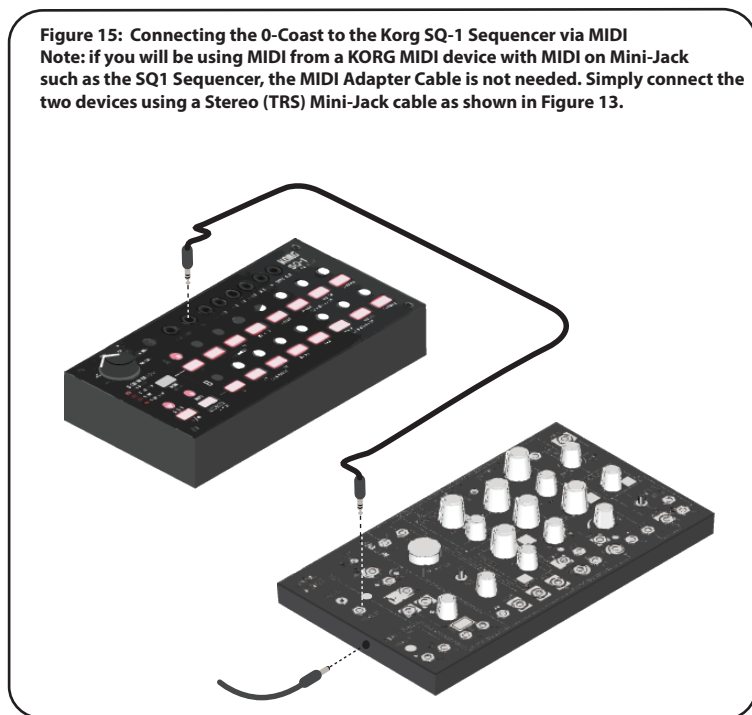

If you are not using MIDI or an external CV Controller, set-up the Default Sound Drone (**Figure 9 on Page 9**).

PROGRAM BUTTONS

The PGM_A and PGM_B buttons allow access to a number of functions:

Basic Actions

- **HOLD PGM_B : PANIC!**

Stops MIDI and Arp Notes. If you encounter a "stuck" MIDI note, this will make it disappear. If using the Latch & Shift Arpeggiator type, this will clear all the notes.

- **PRESS PGM_A & PGM_B : Run/Stop Arpeggiator**

This switches between "normal" keyboard play and Arpeggiator. See Page 17 for more information about Arpeggiator types. **NOTE: the Arpeggiator is only played over MIDI.**

Program Pages

The Program Pages allow for setting a number of parameters that are not directly accessible from the panel of the 0-Coast. They can be configured to react in various ways to MIDI data. For example, the CV Output can be assigned to velocity, note number, mod wheel, et al.

The 0-Coast also has a fun Arpeggiator with two modes, an additional LFO at the MIDI B outputs, and the ability to switch between Legato and ReTrigger playing styles.

Here is a description of how to navigate the pages, followed by the page parameters:

Navigation

- **[HOLD] PGM_A** : go to PGM Pages. MIDI_A & MIDI_B will <FLASH twice>, and PGM_A LIGHTS to indicate program ready.
 - **[PRESS] PGM_A** : select PGM Page. Each [PRESS] of PGM_A moves to the next page. When on page 7, which is the last page (Calibrate), [PRESSING] PGM_A exits the Program Pages.
 - **[HOLD] PGM_A** : set Page Parameter to DEFAULT, MIDI_A & MIDI_B will <FLASH twice>. This will reset the current page to the factory default setting.
 - **[PRESS] PGM_B** : set Value of Page Parameter, PGM_B indicates the Value. Each [PRESS] of PGM_B while on a Page will select the next value for this Page's parameter.
 - **[HOLD] PGM_B** : Exit PGM Pages.
-

PROGRAM BUTTONS

The **PGM_A** and **PGM_B** buttons allow access to a number of settings for the **MIDI_A** and **MIDI_B** circuits. If you ever need to restore these settings to the Default Settings just do the following:

[HOLD] PGM_A and **PGM_B** while **[POWERING ON]** the 0-COAST. Once 0-COAST is powered up, it will have **{Default Settings}** and is ready you use.

For the program pages that follow:

1. **{Arpeggiator}: PGM_A = <ON>**

This selects one of two arpeggiator types. (Arpeggiator is activated from the performance page by **[PRESSING] PGM_A** and **PGM_B**, with **PGM_B <lighting>** to indicate **Arpeggiator = ON**.

- **PGM_B = <OFF> – {Latch & Shift} = <OFF> (Default)** This is a traditional arpeggiator, which plays any held notes in the order they are played, at the **0-Coast's** current Clock Rate.
- **PGM_B = <ON > – {Latch & Shift} = ON** This arpeggiator adds notes in the order they are played and continues playing them in order after they are released. Playing any Note a second time removes it from the **Arpeggio**. Up to twenty (20) Notes can be added. If more than twenty Notes are played, each new Note causes the first Note to be removed from the **Arpeggio**.

{Latch & Shift} = OFF is the more traditional arpeggiator while **{Latch & Shift} = ON** is more like a Sequencer in which you play in the notes and the 0-COAST will repeat them at tempo set by the [Tap], TEMPO Input, and/ or MIDI Clock.

2. **{Legato}: PGM_A = <PULSES>**

- **PGM_B =<ON> – {Legato} = <ON>(default)** MIDI A Gate goes High when the first note-on is received and does not low until all note-offs have been received. In other words, there is a single Contour until all notes are released.
- **PGM_B = <OFF> – {Legato} = <OFF>** **MIDI A Gate** goes high with each new Note-on, even if the previous Notes are still being held. With short Onset times, this can result in a new Contour for every Note played even if keys are not released between notes.

The Default is **{Legato} = < ON>**. In this mode, the Gate stays High until ALL note-offs are received. This is the classic monosynth playing style. Once the Onset and Decay have happened the Sustain level will be maintained until the last note is released. The alternate mode, **{Legato} = <OFF>**, is sometimes called re-trigger. In this mode, a new gate is sent to Contour with each note press even if the previous note has not been released yet. This mode works best with short Contour settings, and is useful for punchy attacks on fast passages.

3. **{MIDI Learn}: MIDI_A = <ON>**

This allows the possibility of **MIDI A** and MIDI B to receive data on different MIDI channels. Select which channel(s) are to be Programmed, then send MIDI data to allow it to learn, then, **[HOLD] PGM_B** in order to finish learning.

- **[PRESS] PGM_B** to select **MIDI CV** Channel
- **MIDI_A = <ON>** – Ready to Learn **MIDI A**
- **MIDI_B = <ON>**– Ready to Learn **MIDI B**
- **MIDI_A & MIDI_B =<ON>** – Ready to Learn Both
- **[Play] MIDI data** on Channel to be Learned
- **[HOLD] PGM_B – Learn= <ALL LEDs FLASH 2X>** to indicate Learned & Exit
- **[HOLD] PGM_A** – set to **MIDI CH . ALL (default)**

The Default Behavior is for both **MIDI_A** and **MIDI_B** channels to receive on ALL channels. The **{MIDI Learn}** is live-updating, so playing notes into it causes it to start learning immediately. Unlike other pages, you must **<HOLD>PGM_B** to finish learning. This way, you can audition channels without overwriting. While on this page, the **MIDI_A Activity Window** learn both at once. **<Hold> PGM_A** to set **MIDI_A** and **MIDI_B** to **ALL channels** (in other words, to set this page to Default). Setting **MIDI_A** and **B** to different channels is especially useful when using the 0-Coast as **MIDI-CV Converter** with a DAW, allowing for example, the 0-Coast to play a Bass Line while a modular synth plays a Lead.

4. {MIDI B CV source}: PGM_A = <ON>, MIDI_B = <PULSES>

- PGM_B = <OFF> – Note number
- PGM_B = <ON> – Velocity (default)
- PGM_B = <PULSE> – Mod Wheel
- PGM_B = <FLASH> – LFO ([TAP] PGM_A twice or more to set frequency). This is a Triangle wave LFO with user-defined frequency.

Note gives you the ability to use the 0-Coast as a **MIDI-to-CV converter** for external voltage controlled synths, or to emulate "key-tracking" behaviors found on monosynths. For example, patch the MIDI_B CV to BALANCE CV INPUT in order to have the sound get brighter as the notes go higher (adjust the Balance combo pot further clockwise for more dramatic effect). The Overtone and Multiply settings will determine the maximum brightness. The Simple Bass patch on p.37 is a good starting point. Using this setting along side MIDI A, you could drive an additional VCO or voice, whether in an external modular or other CV controlled synthesizer, or using the **0-Coast's SLOPE** circuit as a VCO.

Velocity can be used to change the timbre of notes depending on how hard they are played, for example patch **MIDI_B CV** to **MULTIPLY** to brighten notes that are played harder. **Mod Wheel** provides an extra manual modulation source to any parameter. If using a DAW such as Ableton Live, you could use this to automate a **Modulation Track**. The **LFO option** is a Triangle Wave whose frequency is set by [Tapping] **PGM_A** when not in the Program Pages.

5. MIDI B Gate Source: PGM_A = <ON>, MIDI_B = <FLASHES>

- PGM_B = <OFF> – Gate goes High with **Note = <On>**
- PGM_B = <ON> – Gate goes High when **Velocity > 50%**
- PGM_B = <PULSE> – Gate goes high when **Mod Wheel > 50% (Default)**
- PGM_B = <FLASH> – LFO ([TAP] PGM_A). This is a square wave LFO with User-defined frequency.

Setting this parameter to Note allows for a new Gate to be generated with each new Note. This is useful for firing the Slope generator with each note, or clocking the Stepped Random output, to generate a new random value with each note. Keep in mind that the Gate's behavior, when Notes overlap, is affected by the Legato setting from PGM page 2. In conjunction with **MIDI B Pitch CV**, this setting is useful as a gate source for a second voice or instrument.

The **Velocity** and **Mod Wheel** options cause the Gate to go High when the selected parameter is above 50%. This is useful for emphasizing louder notes or manually switching between parameter settings. The LFO is a Square Wave, and shares the same rate as the **MIDI B CV Triangle LFO**, set by <Tapping> **PGM_A**.

6. MIDI Clock: PGM_A = <FLASHES>

- PGM_B = <OFF> - OFF (Default)
- PGM_B = <ON> - 1/1

Tempo follows the rate of the incoming MIDI clock. The Tap Tempo and TEMPO Input are added together with the MIDI clock.

7. Calibrate: MIDI_A & MIDI_B = <ALTERNATE>, PGM_A = <ON>, PGM_B = <OFF>

- [PRESS] PGM_B in order to **Calibrate (Note: it takes 3 to 6 minutes)**. This procedure calibrates the **MIDI_A CV Converter**, which is connected internally, to the Voltage Controlled Oscillator. If connected, it will also calibrate the **MIDI_B CV Converter**.

The 0-COAST arrives fully calibrated. There is no need to run the calibration routine unless you are trying to recalibrate MIDI_B CV to drive a device that does not track 1V/ Octave such as the 0-COAST SLOPE circuit, or it has been recommended to you by Make Noise technical Support to do so. Before running either calibration procedure, be sure the 0-Coast has been powered up for at least 20 minutes without interruption. Disconnect MIDI and all patch cables from the 0-COAST.

- To **Calibrate** internal VCO only, adjust the grey Pitch Panel Control Full Counterclockwise, then adjust the Fine frequency until the **Activity Window stays lit instead of flashing**. [Press] PGM_B to run the calibration, which takes about 3 minutes. Once the procedure has begun, do not adjust any parameters on the 0-Coast. During calibration, the PGM_B LED stays ON. MIDI A and exits the Program Page and return to normal operation with the Clock and Stepped Random Activity Windows on.
- To **Calibrate** to an External VCO, patch a basic waveform, such as Sine, Square or Saw Wave, to the 0-Coast TEMPO input. Patch **MIDI_B CV** to the 1V/Oct Pitch input on the external VCO. Again, adjust the **0-Coast Pitch Panel control** Full Counterclockwise and adjust the **Fine-tune** control until the **MIDI_A Activity Window** stays <ON>. Now, adjust the **External VCO's Pitch Panel Control(s)** until the **PGM_B Button LED** is also <ON>. Once both LEDs are lit solid <ON>, [PRESS] PGM_B to begin the **Calibration**. Once the procedure has begun, do not adjust any parameters on the 0-Coast or the External VCO. During calibration, the PGM_B LED stays ON. MIDI A and MIDI B Activity Windows, PGM_A LED, TEMPO LED and Random Voltage LED are OFF. When calibration has finished, the 0-Coast exits the Program Page and returns to normal operation with the Clock and Stepped Random Activity Windows lighting. **This process calibrates the 0-Coast's MIDI_B CV Output to accurately track with an External VCO and takes about 6 minutes.**

MIDI-Controlled MIDI Clock Sync'd Glide/PORTAMENTO

Using MIDI CC 5 and 65, analog, fully programmable, clock-synchronized PORTAMENTO is possible.

Portamento ON/OFF	CC 65= 0 - OFF; 1-127 = ON
Portamento TIME	CC 5 = 0-127; 0= OFF; 1-127= Time interval

Note: Portamento is in 64ths of the main clock. A setting of 50% makes the 0-COAST take a whole clock pulse to arrive to the next note. If the clock or CC 5 changes during Portamento, it adjusts so that it is possible to fully automate this feature.

Note: For either **CC 5** or **CC 65**, 0 is the same as OFF.

For sync to MIDI Clock, MIDI Clock must be set to ON at 0-COAST. (**MIDI Clk=114, 0-OFF, 1- ON**).

Editing Other PGM Page Parameters using MIDI CC:

While the 0-COAST is in the PGM Pages it is also possible to program the 0-COAST PGM Pages using MIDI CC messages. NOTE: these parameters can only be edited by CC while the 0-Coast is in the Program Pages. The 0-COAST will ignore these CC messages at all other times. There are also some additional parameters that may be edited by MIDI CC. These are Pitch Bend, AfterTouch and Velocity Scale and TEMPO IN Divisor. Here is a list of CC#'s for doing so:

ArpON/OFF=117	Turns Arpeggiator ON/OFF	0-OFF; 1 to 127 is ON
ArpType=119	Selects Arpeggiator type	0-Traditional; 1 to 127-Latch & Shift.
LegatoControl=118	Turns Legato ON/OFF	0 -OFF; 1 to 127-ON
MIDI A Channel =102	Selects MIDI A Channel	Value of 0-15 sets a channel; 16-127 is MIDI CH. ALL
MIDI B Channel=103	Selects MIDI B Channel	Value of 0-15 sets a channel; 16-127 is MIDI CH. ALL
MIDI CH. A CV=104	Sets what comes out of the channel's CV output.	0-Note; 1-velocity; 2-mod; 3 to 127 LFO (rate set by CLock OUT)
MIDI CH. B CV=105	Sets what comes out of the channel's CV output.	0-Note; 1-velocity; 2-mod; 3 to 127 LFO (rate=<TAP> PGM. A)
MIDI CH. A Gate=106	Sets what comes out of the channel's Gate output	0-Note ON; 1-Velocity > 50%; 2-ModWh. > %50; 3 to 127 LFO
MIDI CH. B Gate=107	Sets what comes out of the channel's Gate output	0-Note ON; 1-Velocity > 50%; 2-ModWh. > %50; 3 to 127 LFO
PitchBendScale CH. A=108	Amount of bend in semitones, centered on active pitch (so 1/2up, 1/2 down)	
PitchBendScale CH. B=109	Amount of bend in semitones, centered on active pitch (so 1/2up, 1/2 down)	
AfterScale CH. A=110	Aftertouch in semitones	
AfterScale CH. B=111	Aftertouch in semitones	
VelScale CH. A=112	Sets Minimum Velocity value	
VelScale CH. B=113	Sets Minimum Velocity value	
MIDIClk=114	Turns MIDI Clock ON/OFF	0- OFF; 1- ON
TEMPO IN Div.=116 0 to 127	Divisions of the TEMPO IN as reflected at the CLOCK OUT.	0 and 1= 1/1; 2 = 1/2; 3 = 1/3; 4 = 1/4; etc. Does not affect tap tempo or MIDI Clock.

For more information on MIDI standards, please visit www.midi.org

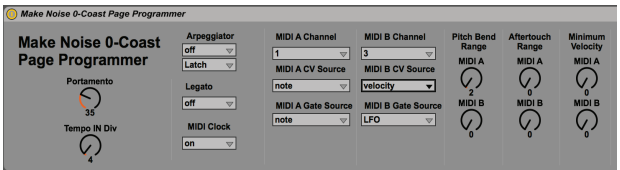

Max 4 Live Page Programmer
Please note we have created a Max 4 Live Device called **Make Noise 0-Coast Page Programmer.amxd**, which makes programming the 0-COAST from Ableton via MIDI very simple. If you use Max 4 Live, have a look:
www.makenoisemusic.com/synthesizers/ohcoast

Figure 16: Connecting the Korg SQ-1 to the 0-Coast via CV/GATE Connections

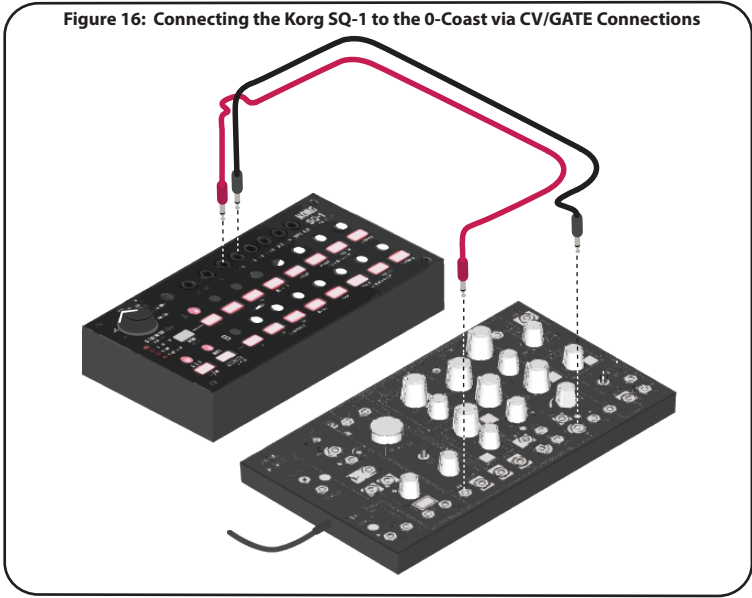

Follow the Arrows!

Aside from the MIDI circuit, the 0-COAST has a 100% analog signal path with Panel Controls for all of the parameters that shape the sound. It helps to learn what each of these circuits does to create, modify, and modulate the sound. The signal path travels from the left to right side of the instrument, starting with the Control circuits and ending with the Dynamics circuits. If you look at the face of the 0-COAST, you will notice gold wires representing this signal flow (**Figure 1**). Some of these connections are always in place, while others are Normalizations, which means they could be re-routed using patch cables. These Normalizations are indicated wherever you see the gold wire terminating in an arrow pointing to an Input jack (**Figure 17**).

Outside Influence, Control: CTRL

This is where the MIDI, Clock, Random Voltage, and CV Processing circuits are located. These circuits allow for controlling, modulating, and synchronizing the 0-COAST from external sources via the MIDI Input, External CLOCK Input, or TAP Tempo functionality.

The MIDI Input uses a Mini-Jack connector as opposed to the more traditional and cumbersome DIN connector. This Mini-Jack connection is very simple and lightweight if you will be using MIDI from a MIDI device with MIDI on Mini-Jack such as the Korg SQ1 Sequencer or the Electribe 2. Simply connect the two devices using a Stereo TRS Mini-Jack cable, as depicted in **Figure 15**. To use the 0-COAST with traditional DIN devices, use the included MIDI Adapter cable. Once MIDI communication is established (See Getting Started Section), you may want to customize the MIDI settings for some special use. We have provided two different ways for users to modify MIDI settings: Local Programming and Sysex programming. For more information, see the section titled: "Using the 0-Coast with Other Devices" in the second half of this manual.

If you follow the gold wire from the **MIDI A CV circuit**, you will see that it is connected to the **Oscillator (Figure 18)**. This wired connection between the MIDI A circuit and the Oscillator circuit allows for playing the Pitch of the 0-COAST from a MIDI controller. To hear this, first, set 0-COAST to the "Default Sound" (**Figure 8**) and then patch your MIDI controller as in **Figure 14**, and then play some keys or send a sequence from your MIDI controller. This Connection is always in place and may not be re-routed; however, you could patch a CV Signal to the 1V/Octave input on the OSCILLATOR to control PITCH from a different source or two sources at once (i.e. MIDI and CV).

Figure 17: Typical Normalization Label

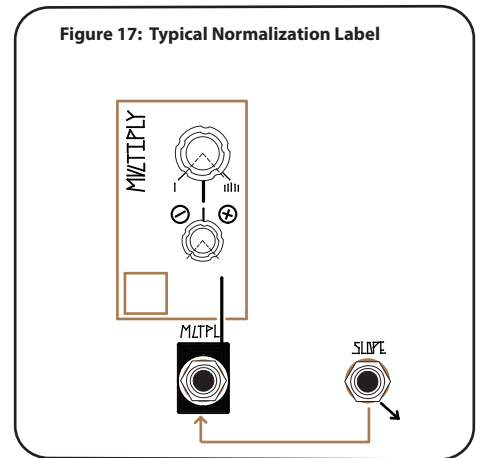
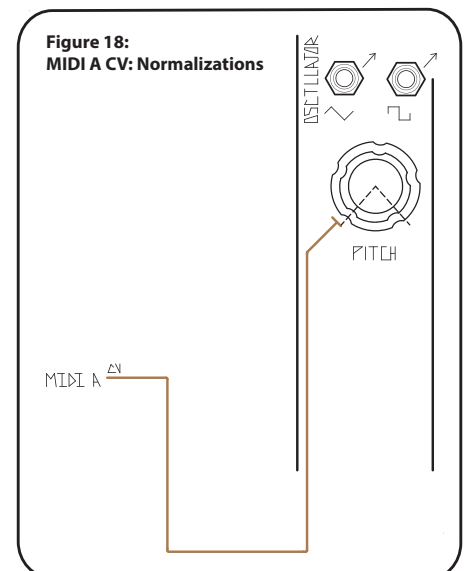

Figure 18: MIDI A CV: Normalizations



Every element of the 0-Coast exists with signals in mind, whether creating, modifying or sending them. Signals interacting with one another is the heart of the way modular synthesizers work. Signals appear at outputs and can be patched to inputs. They take the form of voltage at various levels within the range of +/-10V.

There are several basic signal types. Each input tends to “expect” a particular type, but since they all take the same form (+/-10V) there are many cases where using the “wrong” type is just as musically useful as the “right” one. Don’t get too hung up on it. There are quite a few “gray areas” where a signal could be interpreted as more than one type depending on its use, so again, experimentation is paramount. Here are some basic signal types, accompanied by graphical representation of voltage over time:

Audio:

Audio signals change voltage levels, or oscillate, in the frequency range that is audible to human beings. This is the type of signal that you can actually hear when you send it to your monitoring system. In some cases, Control signals can also oscillate at audio rate.

Example:

Triangle and Square Waveform Outputs

Figure 20: An Audio Rate Triangle Wave

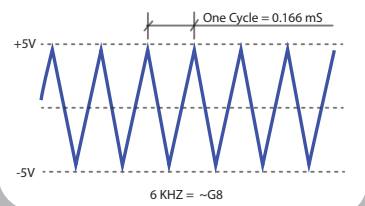

CV: LFO (Low Frequency Oscillator):

The term “control voltage” refers to any continuous signal that you use to control a parameter. In many cases, CV moves at too low of a frequency to be audible if amplified. Instead, you will hear the results of a CV changing an audible parameter.

Example:

SLOPE Output

Figure 21: A Low Frequency Oscillator

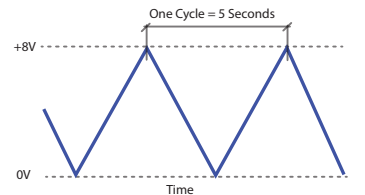
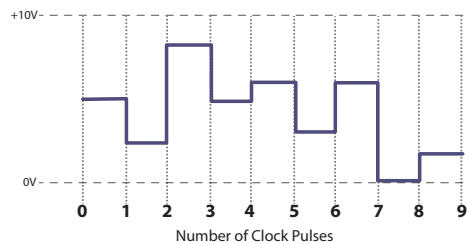

Figure 22: Stepped Random Voltage



CV: Random Voltage

Random Voltage, as you might have expected, is not predictable. In a more subtle use, Random Voltage can live up a patch, creating shades of unpredictability. It may be used to generate unpredictable timbral shifts in predictable melodies, or it could generate unpredictable melodies with timbral and rhythmic shifts created by gestural control of the performer. It provides some voice for the synthesizer’s “Id,” thus allowing you to jam with the machine. At the extreme, with creative patching it can be used as the hub of self-contained generative music systems.

Example: Stepped Random Output

Gates and Clocks:

Triggers, Gates, and Clocks are used to initiate events and switch between states. Instead of being continuous like CV, they have only two states, Gate High and Gate Low. “Gate High” is usually a +8V signal whose length (in time) is variable (Figure 23). “Gate Low” is 0V (or no signal at all).

There are a lot of similarities between these signal types. Keep in mind, the 0-Coast responds to like signals in similar ways. A Gate; however, is longer, anywhere from a few milliseconds to “always on.” The length of the Gate (in time) is referred to as the Gate’s Width. Similarly, Clock Signals are like Gates that go High” at regular intervals (Figure 24). Gate and Gate Outputs are specially made to patch such inputs, but most such inputs will respond to any signal that moves from 0V to 2V or higher.

Examples:

Gate Outputs: EON Gate Output

Clock Outputs: CLOCK Output

Figure 23: Typical Gate Signal

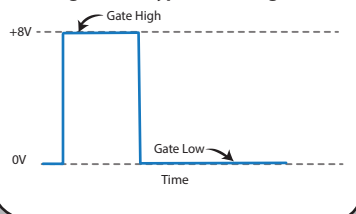
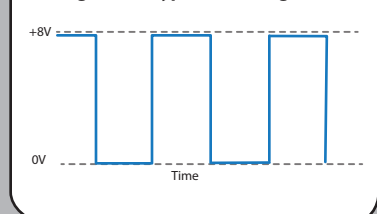
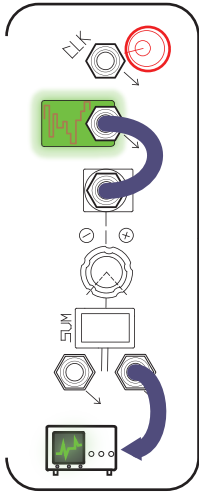

Figure 24: Typical Clock Signal





Attenuation

To Attenuate a signal is simply to decrease its amplitude. Attenuating an Audio Signal has the effect of making the signal softer/quieter. Attenuating a Control Voltage signal has the effect of decreasing the Modulation Depth, reducing the amount of effect the source signal has over the destination.

Examples

0-Coast has a Multiply Attenuverter, which controls the Depth of Modulation to its respective parameter (more on that later). For CV Input Attenuators, such as Overtone, zero amplitude is at full counterclockwise, resulting in no modulation regardless of the signal input.

Figure 25:
Random Stepped Voltage

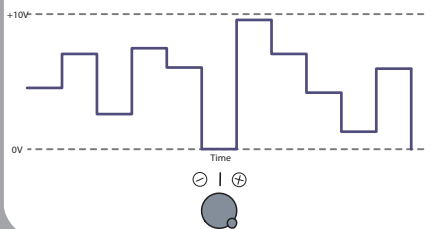

Figure 26:
Random Stepped Voltage (Attenuated)

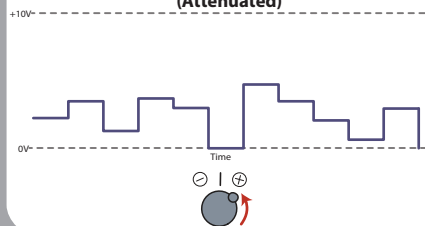
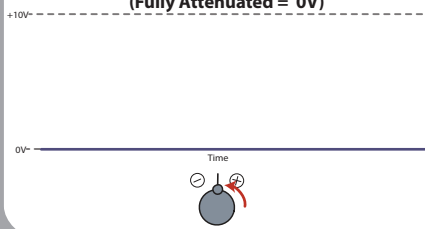

Figure 27:
Random Stepped Voltage (Fully Attenuated = 0V)



Inversion

To invert a signal is simply to turn it "upside down." For example, inverting a +5V offset results in a -5V offset. Inverting a positive-going sequence (Fig. 28) results in a negative-going sequence with the same "intervals" between steps (Fig. 29). When applied to a melody, this is a classic technique of Counterpoint.

Inverting Audio Signals has no effect on their sound in most cases, except for when mixing them with related signals, or when inverting them multiple times per cycle (see Make Noise modDemix, "Ring Modulation.")

An **Attenuverter** allows a signal to be inverted or non-inverted at a user-definable percentage of its original amplitude, with Zero at 12 o'clock. CV inputs, such as Multiply CV, have onboard Attenuverters in order to easily Modulate a parameter in either direction, at any Depth.

Figure 28:
Random Stepped Voltage (Attenuverted)

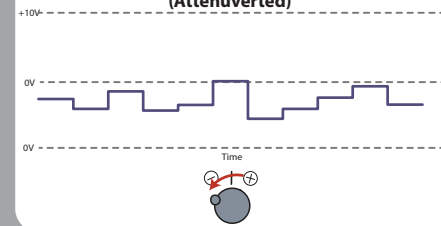
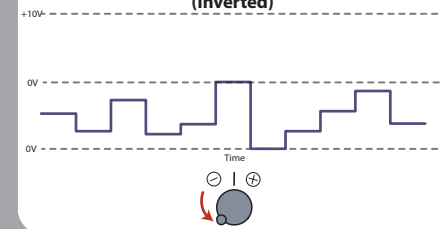

Figure 29:
Random Stepped Voltage (Inverted)



An example use for the Attenuverter on the Control Processor's CH.2 Input is patching a variable depth Vibrato. If you patch a Cycling Slope directly to the 1V/Oct input on the Oscillator, you get a vibrato, but with a range of many octaves. Instead, try patching it to the right input of the Control Processor, take either output to 1V/Oct, and adjust the Depth using the CH. 2 attenuverter. With this patch you can still control the pitch of the Oscillator using the MIDI Input. The other output is identical to the first, so you could control modulation Depth from Slope to two different parameters at once using the single Attenuverter.

If nothing is patched to the left input, it is disregarded. If nothing is patched to the right input, it is Normalled to an Offset, which can also be attenuverted. The perfect example of this offset by itself is the Default Sound Drone patch, **Figure 9**. In this patch, the Offset is patched to the Dynamics circuit to allow sound to pass through at all times

As mentioned above in (1), the left input is always at "Unity" (there is no control over its amplitude), while the right input comes with an attenuverter. An example of the usefulness of inverting a signal: say you want to have the value of Overtone go lower as Contour goes higher, so it is modulated by Contour in the opposite direction from the Dynamics circuit. To do this, you could set Overtone full clockwise, patch Contour to the CH.2 input, set the CH.2 attenuverter full counterclockwise (as in **Figure 31**), patch its output to the Overtone CV input, and set the Overtone CV Attenuator Full CW.

Since the two outputs are identical to each other, the Control Processor is also a multiple and can be used to send one signal to two destinations. Just patch to the right input and turn the attenuverter all the way clockwise, and you have two identical outputs available. If the signal you are patching is also normalled somewhere, it could be sent to a total of three destinations. For example, Slope could be patched to Multiply (via normalization), Balance, and Overtone all at once.

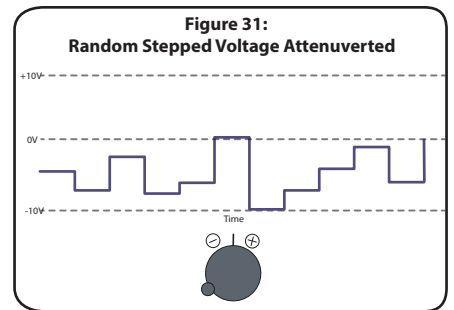
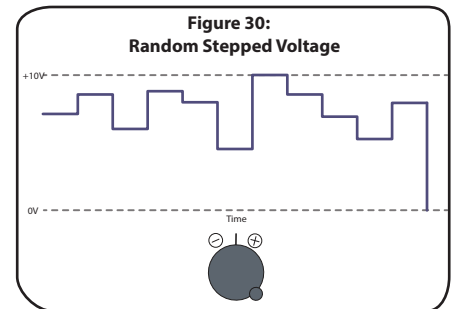
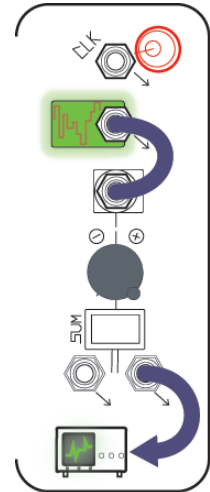

Now that we've discussed the use of Control Voltage to manipulate parameters over time, it is important to introduce the concept of attenuation as a method of controlling the range of movement.

Using a unipolar Control Voltage like from Slope, it is possible to control the range and direction of modulation, in relation to the 0-Coast's Panel Control setting, simply by adjusting the position of the associated Input Attenuverters. For example, using the Slope normalization to the Multiply CV Input, this has the effect of manually rotating the Multiply Panel Control knob over time, starting with the initial Panel Control setting shown below.

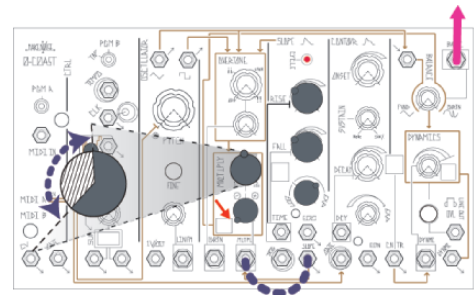
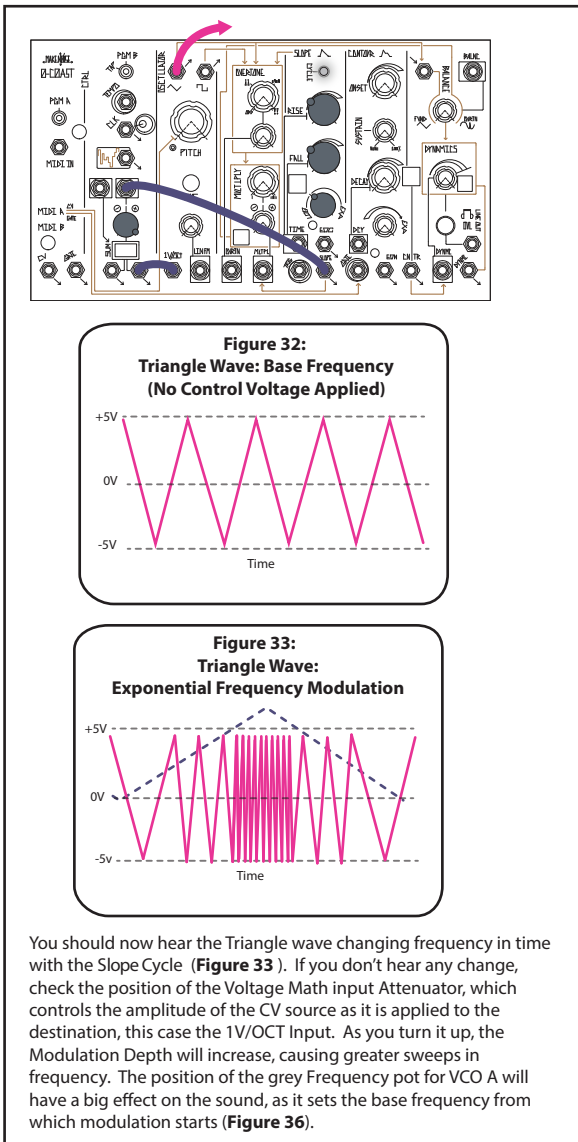

Figure 34: Adding the Slope's unipolar voltage to the Multiply Panel Control knob. The resulting "range" of movement is indicated by the crosshatched area of the Multiply Panel Control.

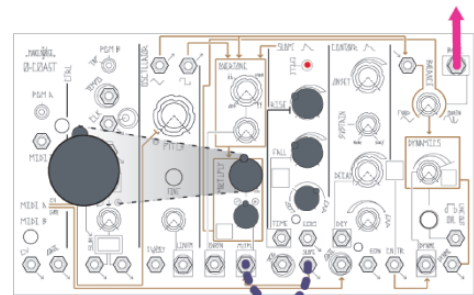

Figure 35: With the Multiply Input Attenuverter set to 12:00, no voltage is added to the Multiply Panel Control setting and therefore there is no audible effect.

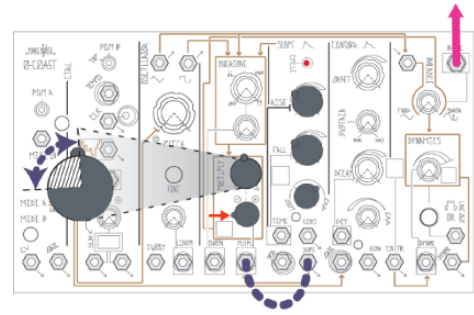

Figure 36: Adding the Slope's unipolar voltage to the Multiply Panel Control Offset. The resulting "range" of movement is indicated by the crosshatched area of the Multiply Panel Control.

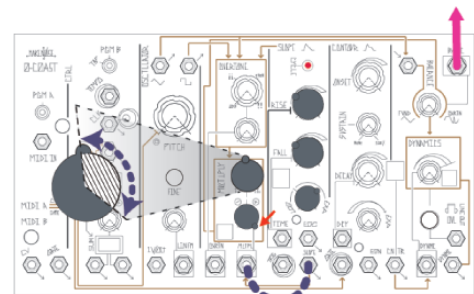

Figure 37: Subtracting the Slope's unipolar voltage from the Multiply Panel Control Offset, using the Multiply Input Attenuverter to invert the signal's polarity. The resulting "range" of movement is indicated by the crosshatched area of the Multiply Panel Control.

Set 0-COAST to the "Default Sound" (**Figure 8, Page 9**). To hear how the Oscillator works, it is helpful to either hold a key down on your controller, or to set the 0-COAST to Drone, as shown in **Figure 9**.

The voice of the 0-COAST begins at this circuit: a Triangle core, voltage-controlled oscillator (VCO) that generates two waveforms: Triangle and Square, as illustrated in **Figure 39**. The **Oscillator** is the primary sound source of the 0-COAST. Set **Balance** to Full CCW so that it is passing the internally-routed Triangle waveform signal.

The Triangle waveform has so few audible Overtones, it is nearly a pure representation of our single Fundamental frequency, which is determined by the Pitch Panel controls, MIDI, and CV patched to 1V/ Octave Input. The sound of the Triangle is smooth and pure. The Triangle waveform is often used as the starting point for West Coast synthesis techniques.

Now, grab a patch cable and patch the Square Output from the **Oscillator** circuit to the Balance Ext. Input, **Figure 38**.

Figure 38:
Patch Instruction: SQUARE OUT to Balance Ext. Input

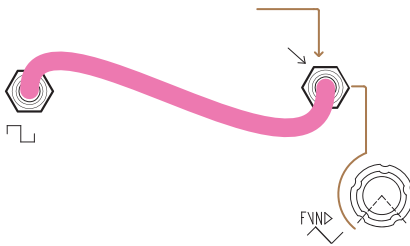

What is an oscillator?

An oscillator outputs repeating voltage in the range of -5v to +5v. The core of the 0-Coast generates voltage that ramps up in a straight line and then back down, creating a triangle shape. The other waveform outputs are created by using circuitry to mold the Triangle into other shapes, each of which has a unique sound. The frequency of oscillation determines the pitch: the higher the frequency, the higher the pitch.

An oscillator is ALWAYS oscillating: the only thing that stops it is powering down the system.

Figure 39:
0-Coast: Simultaneous Waveform Outputs

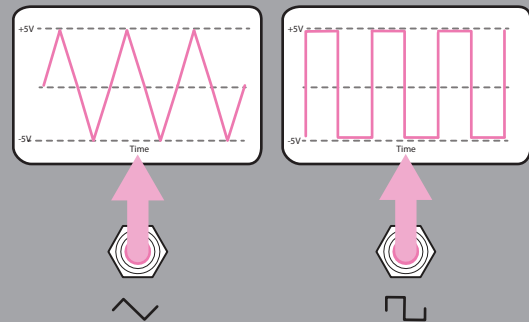

Be sure the Balance Panel Control is still set to Full CCW. You should now be hearing the Square waveform, which has many audible Odd Overtones, making it more rough and complex. This gives it a hollow aggressive sound. The Square waveform is often used as the starting point for East Coast synthesis techniques. These two waveforms: Triangle and Square, are wonderful sounds. You may manually control the pitch using the Pitch Panel Controls Coarse and Fine for immediate physical control of Pitch, just like on a modular synthesizer. You may also control the Oscillator using the MIDI Input or patching a CV signal to the 1V/Octave CV Input. Try controlling the pitch of the Oscillator in these ways and comparing how the Square and Triangle waveforms sound at different pitches, high and low frequency.

If you follow the gold wires from the outputs of the Oscillator Circuit, you see that the Triangle and Square waves are wired to the Overtone circuit (**Figure 40**), where the Square waveform is used to add an Overtone to the Triangle waveform (you might have noticed that the Slope is also routed to the Overtone circuit, more on that in second half of this manual). This wired Connection between the Oscillator and Overtone circuits allows for shaping the timbre of the 0-COAST.

Figure 40: Typical Normalization Label

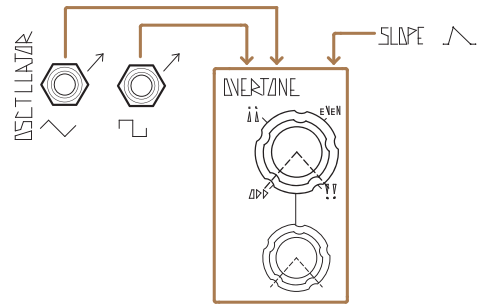

Overtone adds sound that is higher in frequency, yet still harmonically-related to the Fundamental. In order to hear the effect, return the 0-COAST settings to the Default Sound and then set the Balance control Full CW, so that you are only hearing the Overtones. Hold a key on your controller or set the 0-COAST to Drone (refer to **Figure 9, Page 9**). Slowly turn the Overtone Panel Control Clockwise and listen for the change in the timbre of the sound as the single Overtone fades from **ΔΔΔ** to **ii**, which is a transitional state, to **EVEN** and finally to **!!** where the Slope circuit is blended into the audio signal path. To hear the Slope in the audio signal path set Slope to Cycle and set Rise and Fall to 9:00 for Audio rate Slope generation. Set Overtone Full CW. This creates a very inharmonic sound, not unlike a Ring Modulator, unless you tune the Slope to the Oscillator.

Follow the short gold wire from the Overtone to the Multiply circuit: ↓

This indicates the wired connection of the signal from the Overtone circuit to the Multiply circuit where that single Overtone is multiplied, thus creating additional Overtones and a more harmonically-rich sound. Set **Overtone** to **Even** and then turn the Multiply Panel Control slowly Clockwise until it is Full CW. You may be able to distinguish each new Overtone slowly increasing in volume as you turn the Multiply Panel Control Clockwise. This is the opposite of what happens in a Low Pass Filter: the East Coast synthesis circuit commonly found in mono-synths. Rather than starting with a waveform that already has many harmonics, such as the Square wave, and subtracting them from that signal using a Filter, the Multiply circuit **ADDS** Overtones to a waveform that has few harmonics, **Figure 41**. This primitive addition technique is an important part of West Coast synthesis.

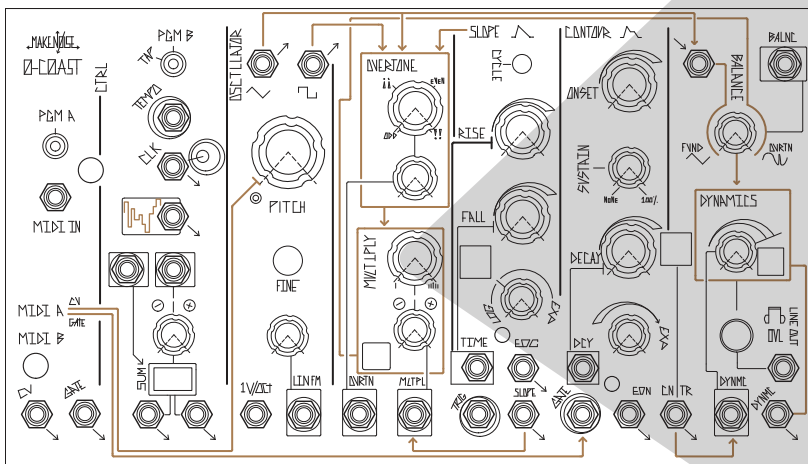
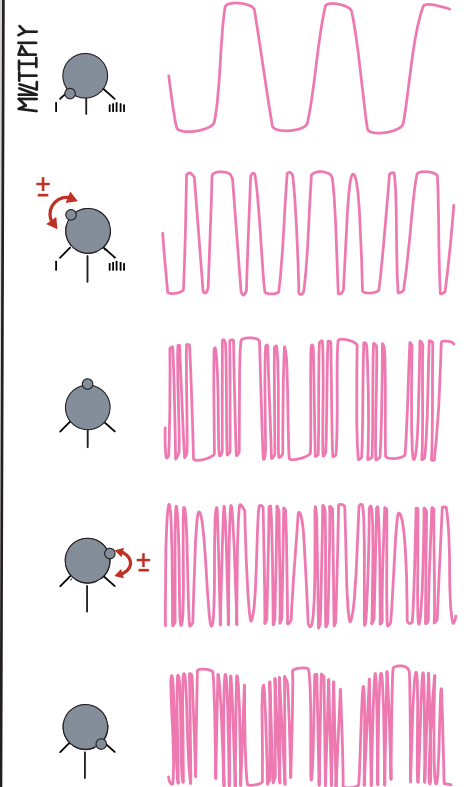
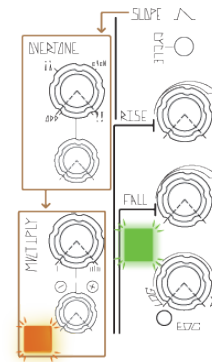

Figure 41: OVERTONE: Harmonic MULTIPLY Panel Control



In addition to the Multiply Panel Control the Slope circuit could act as a “ghost hand” to adjust the Multiply Panel Control in your absence. A gold wire indicates the Slope circuit is able to modulate the Multiply circuit via a Normalization at the Multiply CV Input Jack. This means that with nothing patched to the Multiply CV Input Jack, the Slope Signal Output will pass through the Multiply CV Input Jack to the Multiply CV Attenuverter and from there it goes on to modulate the Multiply circuit. One way to hear this is to set the Slope circuit to Cycle by [Pressing] the Cycle Button until it <lights white>. Adjusting the Rise, Fall, Vari-Response, and Multiply CV Attenuator and Panel Controls alters the way the timbre of the 0-COAST is modulated. The CV Attenuverter is capable of adding and subtracting from the Panel Control with the “OFF” point being at 12:00. The Slope and Multiply Activity Windows <light> to indicate the activity (**Figure 42**). Before you read on to learn the functionality of these controls, take a moment to experiment and search for unfound sounds.

Figure 42: MULTIPLY and SLOPE LED Activity



The Slope may be Triggered or set to Self-Cycle. Triggering creates a single cycle: a single shot function starting at 0V, traveling up to 8V and then immediately beginning the descent back to down to 0V. We will learn more about Triggered Slopes in the second half of this manual. Begin by setting Slope Self-Cycle ON. This creates a continuous Function starting at 0V, traveling up to 8V, and then immediately beginning the descent back to 0V, repeating this behavior until the the Cycle Button is [pressed] again to disengage Self-Cycle. This type of Function is often called a Low Frequency Oscillator or LFO: an important element of both EAST and WEST Coast synthesis techniques.

Rise sets the amount of time the circuit takes to travel up to the maximum voltage level. Setting Rise to be more clockwise increases the time it takes for the Slope to reach the maximum level, thus slowing down the LFO.

Fall sets the amount of time the circuit takes to travel back down to the minimum voltage level. Setting Fall to be more clockwise increases the time it takes to for the Slope to reach the minimum level, again, slowing down the LFO.

Figure 43 RISE and FALL Times; Linear Response

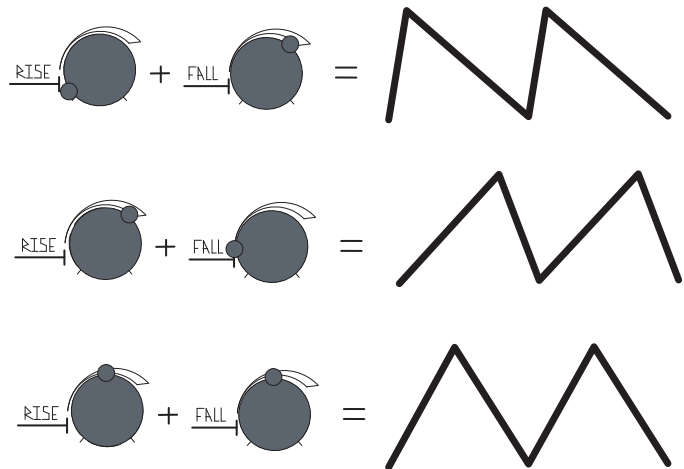

These two controls are also useful for determining the shape of the LFO. For example, a fast Rise Time with a slow Fall Time results in a Saw shape. If Rise and Fall are set to similar times, it results in a Triangle shape. (**Figure 43**).

Vari-Response shapes these rates of change (i.e. Rise/ Fall) to be Logarithmic, Linear, or Exponential (**Figure 44**). With LOG response, the rate of change decreases as the voltage Increases. With EXPO response, the rate of change increases as the voltage increases. Linear response has no change in rate as the voltage changes. The Vari-Response control is also useful to increase or decrease the overall time or speed of the LFO. Setting Vari-Response more clockwise to be more Exponential increases the LFO rate, while setting it to be more linear decreases the LFO rate.

Figure 44: Vari-Response Settings

Note: This assumes the Rise Panel Control is set Full CCW so it is not affected. Also, this assumes FALL is set to around 10 o'clock.



The Balance circuit provides variation in the blend of the Fundamental frequency of the Oscillator Core and the harmonic Overtones that are generated by the Overtone and Multiply circuits. Follow the gold wire out of the Multiply circuit past the Contour circuit all the way to the right side of the Balance circuit, which is marked OVRTN. Notice another gold wire indicating a normalization of the Oscillator Triangle waveform to the left side of the Balance circuit via the Balance Ext. Input. The left half of the Balance parameter is marked FUND (Figure 45).

FUND is short for Fundamental. This is the Fundamental frequency or pitch of the Oscillator Core. The Triangle waveform represents it well, since it has few audible harmonics. OVRTN is short for Overtone. This is the Oscillator Core as processed by the Overtone and Multiply circuits. This signal is rich in harmonics- all of which are above the fundamental frequency of the Oscillator Core and are thus referred to as Overtones.

To hear how the Balance works, first, either hold a key down on your controller, or to set the 0-COAST to Default Drone shown in **Figure 9, Page 9**.

Sweep the Balance Panel Control from Full counterclockwise to Full clockwise. The sound starts as a simple, smooth tone and morphs into a more complex rough sound rich in harmonics. This is not unlike sweeping a Low Pass Filter in the classic East Coast synthesis patch, where at Full Counterclockwise, the harmonics of the Square or Saw waveform are reduced to almost nothing and the sound is smooth and dull and further increasing the Filter cutoff parameter causes the sound to become brighter and more complex.

Balance is useful for taming the complex and often highly-animated timbre of the 0-COAST. It allows for strong introduction and control over the Fundamental frequency. This is the portion of the 0-COAST sound that has the potential to produce a strong low end when desired. Because the Overtones are all above the Fundamental frequency, the the Fundamental portion that is the left half of the Balance control almost acts as a sub-octave relative to the right half of the control: the Overtone portion. Sweeping the Balance manually or by voltage control (which we will get into in the second half of this manual) may provide quite a bit of East Coast Synthesis gratification, even if the method for achieving these results is rooted in West Coast Synthesis. This blurring of the stylistic coastal lines is the essence of 0-Coast Synthesis.

Now, apply your knowledge of the Overtone, Multiply, and Balance circuits to alter the timbre of the 0-COAST manually by experimenting with different settings of the associated Panel Controls. Set Slope to Cycle in order to modulate functionally over time.

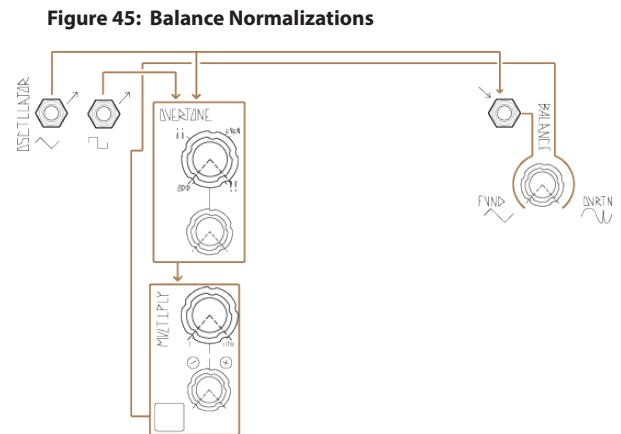

DYNAMICS

A short gold wire indicates the wired connection from the Balance to the Dynamics circuit (Figure 46). The Dynamics circuit provides simultaneous control over the Amplitude and Frequency content of the signal coming from the Balance circuit. It is in essence, a Low Pass Voltage Controlled Filter-Amplifier. One way to listen to the effect of the Dynamics circuits, is to set up the Drone Patch (Figure 9, Page 9) . Set the Dynamics Panel Control to Full CCW. Set the Balance Combo Pot to 3:00. Set Overtone Panel Control to Even and Multiply Panel control to 12:00. You should hear no sound. Now, slowly sweep the Dynamics Panel Control to Full Clockwise. As you do so, the sound gets both louder and brighter while the Dynamics Activity Window [Lights Orange].

As you further increase the level of the Dynamics circuit, the sound becomes both louder and brighter, functioning in a way that is similar to that of the Buchla 292 Low Pass Gate: a fundamental element in the sound of West Coast Synthesis. However, rather than using the Vactrol component that gave the Buchla 292 its characteristic “slow” sound, the Dynamics circuit utilizes transistors in a topology that has more in common with East Coast instruments and perhaps even Far East Coast instruments :) This combination of West Coast technique and East Coast circuitry is 0-Coast synthesis at its finest, allowing the Low Pass Gate to be used in tandem with an extremely-important East-Coast synthesis circuit: the 4-stage Envelope we call Contour.

CONTOUR

In order to really understand the effect and use of the Dynamics circuit, you must also get to know the Contour circuit, which is Normalled to the Dynamics CV Input, as indicated by the gold wire connecting the Contour Signal Output to the Dynamics CV Input Figure 47. You may recall that the Contour circuit has the Gate Input Normalled to the MIDI A Gate Output, so striking any key on your MIDI controller or running a MIDI sequence generates a Gate that initiates the Contour circuit. If you are not using MIDI, you can patch up **Default Percussion Sound (Figure 52)**. You should hear a percussive sound and you should see the Contour function window and the Dynamics Activity Window <lights> to indicate activity as these Gates are generated.

Figure 47: CONTOUR Normalization

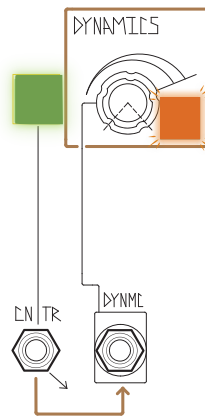
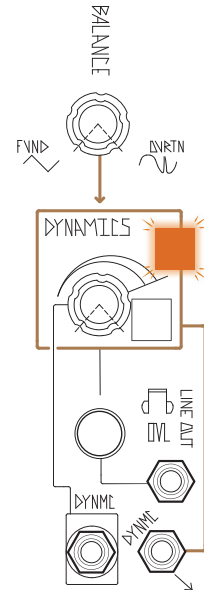

Figure 46: DYNAMICS Normalizations



What is a VCA?

A VCA uses one signal to control the amplitude of another.

Figure 48: VCA Response to Unipolar Control Voltage

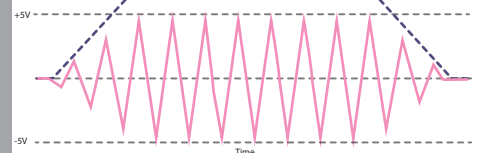

The Control Signal is an Envelope (0-8V), the Audio Signal a Triangle Wave (+/-10Vpp). The result at the output is a Triangle Wave whose amplitude is controlled by the envelope.

Figure 49: VCA Response to Bipolar Control Voltage

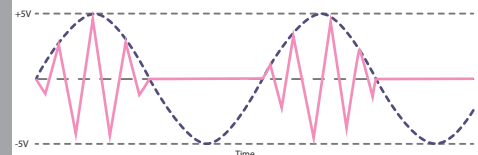

The Control Signal is now a low-frequency Sine wave (+/-10Vpp), the Audio Signal is a Triangle Wave (+/-10Vpp). Note: the Negative portion of the Control Signal has no effect, as the amplitude of the signal cannot go below zero.

CONTOUR (cont'd)

CONTOUR is a 4 Stage function generator that creates control voltages to drive the Dynamics circuit, resulting in amplitude envelopes which greatly define the sound of the 0-COAST. This approach takes inspiration from the original Loudness Contour circuit of the MiniMoog, which is perhaps the most well-known and heavily-used example of East Coast Synthesis.

ONSET sets the amount of time the circuit takes to travel to its maximum level, which is where the sound will be loudest when Contour is driving the Dynamics circuit. Setting Onset to Full Counter clockwise causes the sound to reach maximum level almost instantaneously, resulting in a very percussive, impactful sound. As the Onset Panel Control is set more clockwise, the circuit takes more time to travel to the maximum level: the sound taking longer to fade into existence.

As soon as the Contour circuit reaches the maximum level, it begins to Decay to the Sustaining level where it remains for as long as the Gate (e.g. from MIDI or Patched to Contour Gate Input) is held High or On (**Figure 50**).

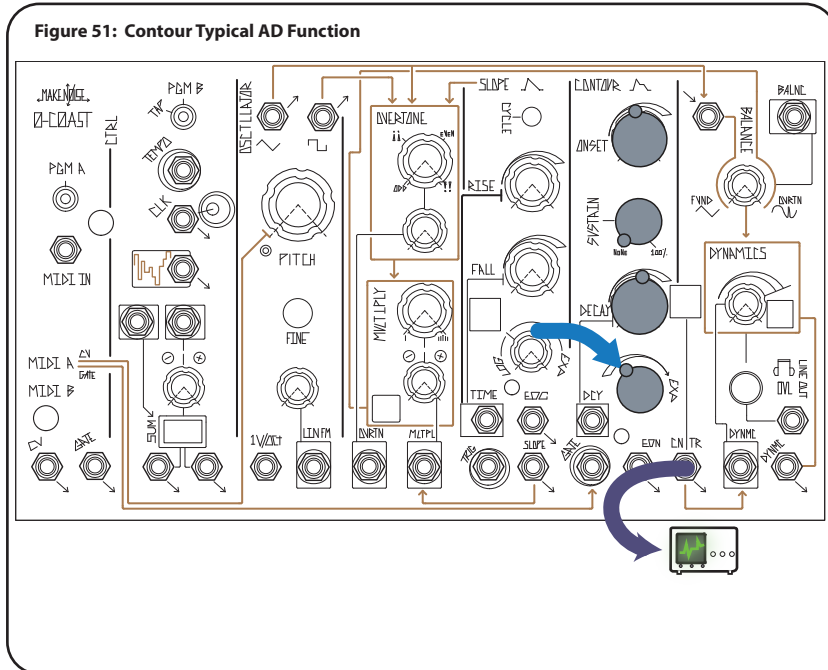
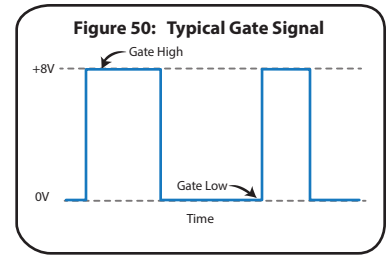

The Sustain parameter determines this maximum level, while Decay sets the time it takes the circuit to reach the Sustain level. With Sustain set to Full Counterclockwise, there is no Sustain and the Contour immediately Decays to the minimum level of 0V, or silence when driving the Dynamics circuit, thus operating as a 2 Stage Function, similar to the Slope circuit (**Figure 51**).

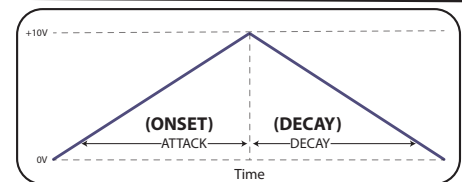

Attack Decay (AD): The Function is initiated once the Gate is received at the MIDI Input Input, at a Rate and Shape set by the Onset and Vari-Response Panel Controls and increases until it hits its maximum value of 8V. Next, the Sustain circuits alter the Function according to the Sustain Panel Control. Finally, the Function "Releases" back to 0V at a Rate and Slope determined by the Decay and Vari-Response Panel Controls. Note: Gate Length is ignored, as only the Rising Edge is "seen" by the input.

Figure 52: Default Percussion Sound: [TAP] PGM_B to change rate.

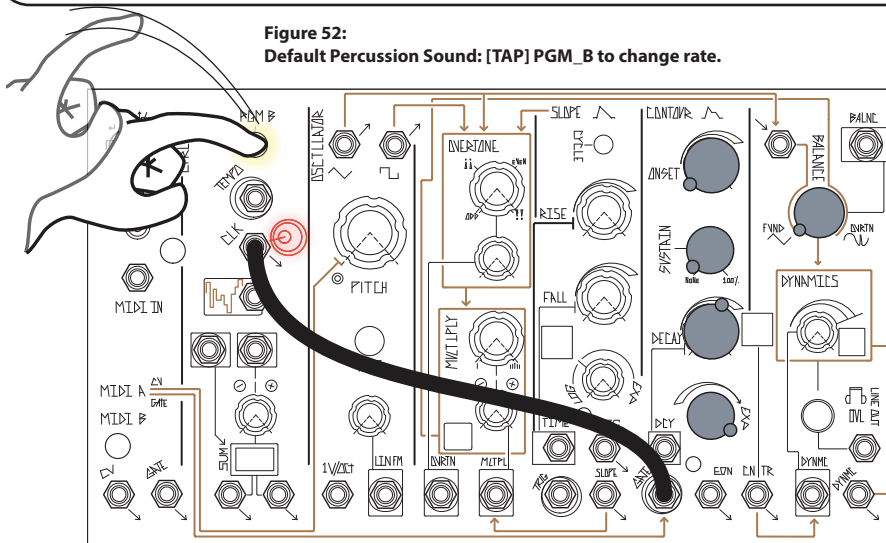

CONTOUR (cont'd)

With Sustain set to Full clockwise, Sustain is maximum, but with no audible Decay, as the circuit remains at the Maximum level. **Figure 53** is a 3 Stage function, operating as an ASR, or Attack Sustain Release envelope. Many older electronic organs utilized this type of Amplitude control.

With Sustain settings anywhere between Minimum and Maximum, the Contour generates a 4-Stage function that, when used to drive the Dynamics circuit, produces the classic "ADSR," or Attack, Decay, Sustain Release Amplitude Envelope, as popularized by the East Coast Synthesis technology (**Figure 54**).

Vari-Response shapes these rates of change (i.e. Onset/Decay) to be Linear, Exponential, and everything in between. With EXPO response, the rate of change increases as the voltage increases. With a LINEAR response, there is no change in rate when the voltage is changing. The Vari-Response control may be used to increase or decrease the overall time or speed of the Contour. Setting Vari-Response more Clockwise in order to be more Exponential increases the rate, causing the 0-COAST to sound more percussive. Setting it to be more LINEAR decreases the rate, causing the 0-COAST to fade in and out of existence.



Experiment with different Onset and Decay settings, while leaving Sustain set to about 11:00, and Vari-Response set to 2:00. This may help you understand what Onset and Decay are doing. Now, set Onset to 9:00, and Decay to 3:00, while experimenting with Sustain settings. Finally, experiment Vari-Response settings using the Panel Controls to change the shape and rate of the Contour..

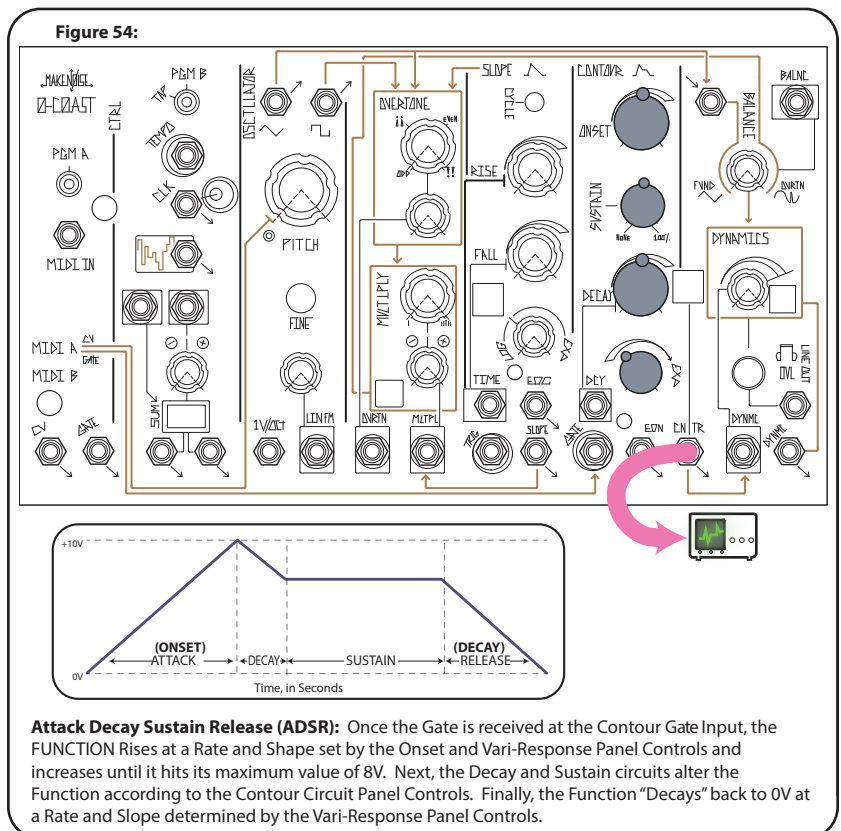
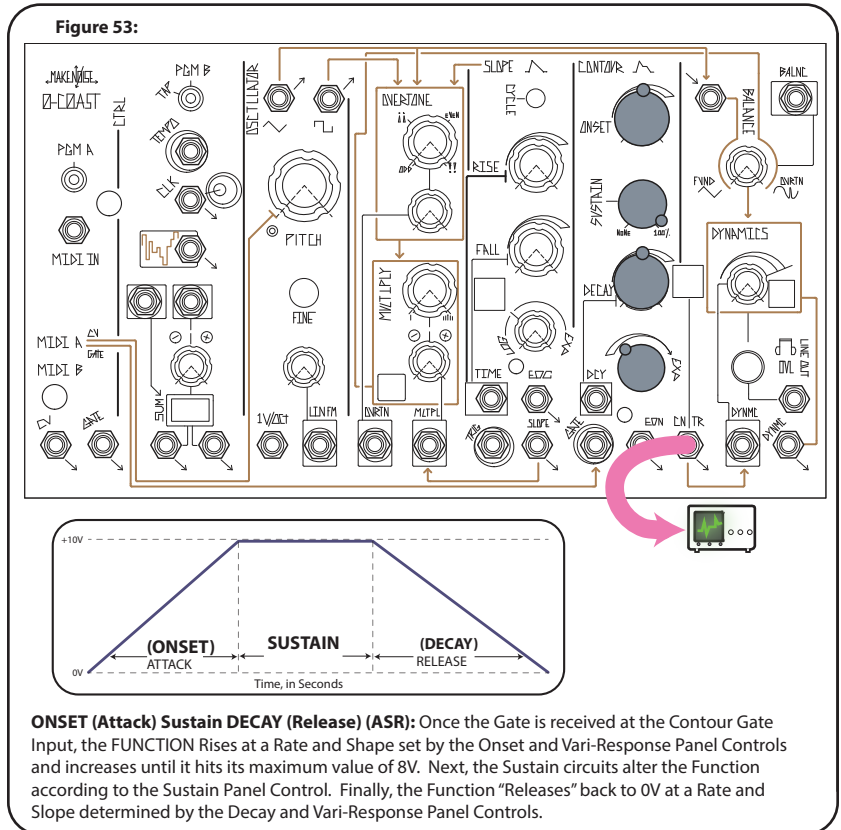

LINE Output

The Default Sound patch utilizes the Line Output for monitoring the 0-COAST. The Dynamics circuit is connected to the Line Output circuit as indicated by the gold wire in **Figure 55**.

While it is not possible to reroute this connection, the Dynamics circuit does have an additional output located below the Line Output called DYNMC OUT (**Figure 56**).

Figure 55:
Line OUTput
Normalization

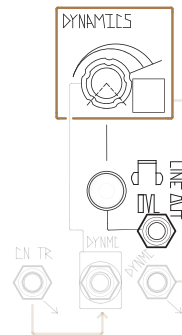
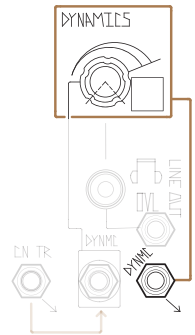

Figure 56:
DYNMC OUT
Normalization



The DYNMC Output is Modular Level and produces a signal in the range of 10V peak to peak, which is more than 3 times the strength of the typical line-level audio signal commonly used in the studio and on stage. The DYNMC Output should only be used when interfacing the 0-COAST with instruments capable of handling the large voltages produced by this type of output, such as modular synthesizers.

The Line Output circuit has a Level parameter which sets the volume. This Level parameter is clean up to about 80%, where it starts to overload and clip. The OVL (overload) indicator will light to indicate this clipping. **The Line Out is a Tip Ring Sleeve** jack that provides a 2-Channel stereo output on a single jack (**Figure 10**). It is also OK to use this output as a Mono output by using a Tip Sleeve cable. This output is capable of driving loads typical of Headphones, long cables runs to a mixer, stomp boxes, and just about any other device with a line-level input.

To this point in the manual, we have used variations of the Default Sound as a jumping off point to explore the sonic parameters of the 0-Coast. These dimensions of sound creation (the Oscillator, Overtone, Multiply, Slope, Balance, Contour, and Dynamics (circuits) are wired together in a way that offers many possibilities at the turn of a knob.

Although these circuits' approach to sound generation and timbre modification are different from those of traditional mono synths, the architecture of this fixed signal path is very similar to them and comes with many of the same advantages and limitations: an example of an advantage is that "typical" sounds played with a keyboard are easy to achieve; an example of a limitation is that the envelope of a note (created by Contour as Gated from the MIDI A Gate) is always tied to a single pitch. (As we'll see later, this limitation can easily be overcome on the 0-Coast.)

In the next section we will go into the inputs and outputs that are not normaled or hardwired, using patch cables to expand the number of connections between the circuits on the 0-Coast. This will allow for greater depth and complexity of sound.

Once we've explored those connections we'll look at the effect of patching to normalled connections (thereby, "breaking" those connections): a practice that overrides the Default Sound and has the potential to change the flow and identity of the instrument entirely.



Figure 57: 0-Coast: Inputs and Outputs

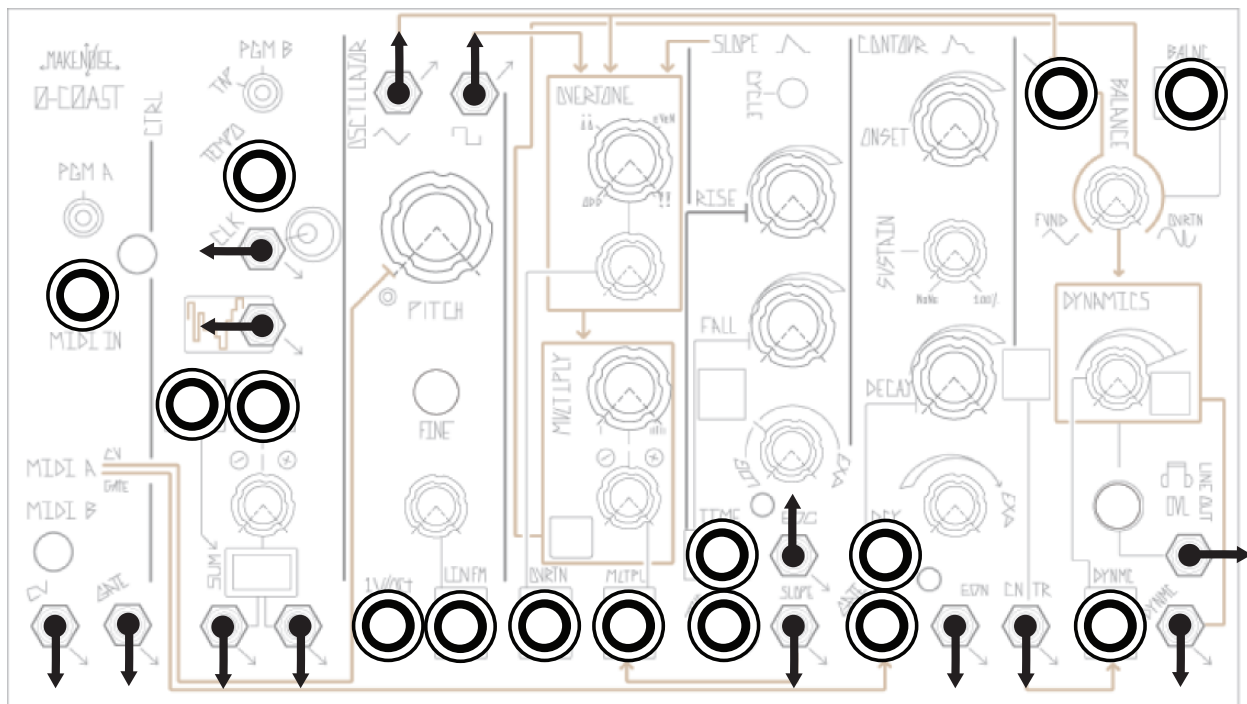

Looking over the faceplate of the 0-Coast, we will see a number of patch points that are not connected by gold wire to any others. To begin, set up the Default Sound Drone (Figure 9). The patch cable used to create this sound is a perfect example of a connection that is not hardwired or Normalled. The output from the Offset Generator is used to hold the Dynamics circuit "open" so that the sound from the Balance circuit passes through at all times. **Without this patch connection, the Dynamics circuit will only open during the duration of an envelope from Contour from a MIDI or Gate event.**

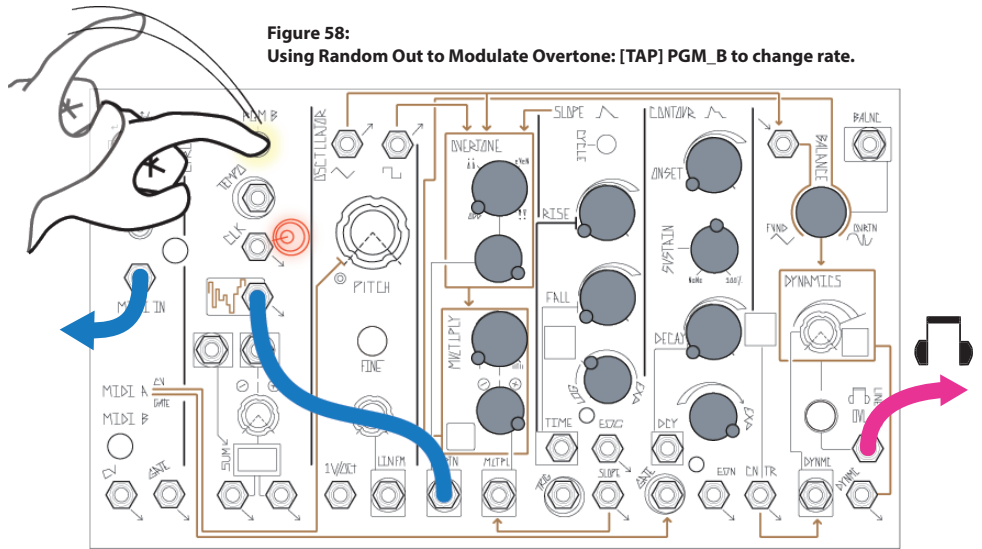

Figure 58:
Using Random Out to Modulate Overtone: [TAP] PGM_B to change rate.

Set Balance to 12:00 or higher so that you can hear the effect of manipulating the Overtone control. Set Overtone to fully counterclockwise (Figure 60). **Patch the Random output to the Overtone CV Input.**

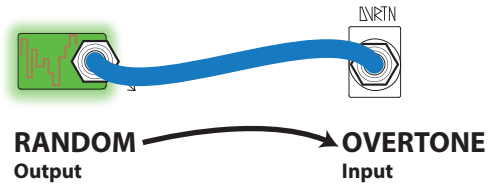

Figure 59: 0% Modulation of Depth

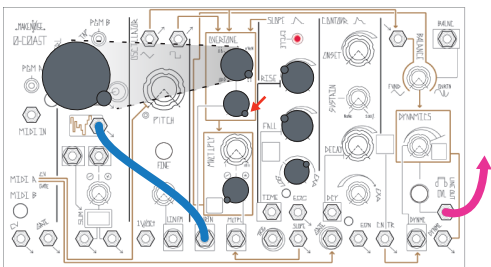

Figure 60: 0% Modulation of Depth

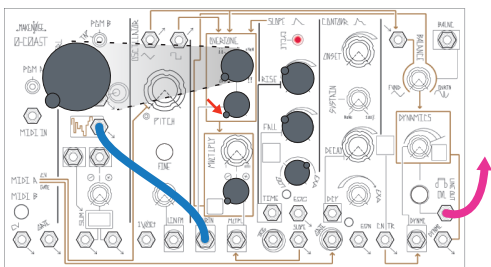
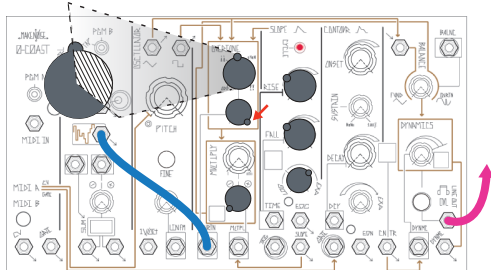

Figure 61: 50% Modulation of Depth



The Random Signal Output passes through the patch cable to the Overtone CV Input Jack to the Overtone CV Attenuator and from there it goes on to modulate the Overtone circuit. Turn the Attenuator up gradually to hear increasing Modulation Depth. Note that if the Overtone Panel Control is turned fully Clockwise, you will not hear any modulation (Figure 59). This is because the Overtone Panel Control sets the base value to which the Modulation is "added." If it is already at maximum, it cannot be modulated any further. When Panel Control is set to 12:00 and the CV Attenuator is set Full counter clockwise, there is no Modulation because the CV Attenuator set Full CCW reduces the Modulation to 0%. Setting the Attenuator to Full CW achieves 50% Modulation depth and setting the Panel Control to the Full CCW will achieve 100% Modulation. You can change the Clock rate by tapping the PGM_B button at the rate you would like the clock to go (if this does not work, see Page 7 "Normalizations").

Random modulation is just one of many possible patches to the Overtone CV Input. Try another source, such as the Slope circuit (remember to engage Cycling). Hear how periodic modulation differs from random modulation. Try adjusting the controls in the Multiply circuit to hear what it sounds like to modulate Multiply and Overtone simultaneously

Figure 62: 100% Modulation of Depth

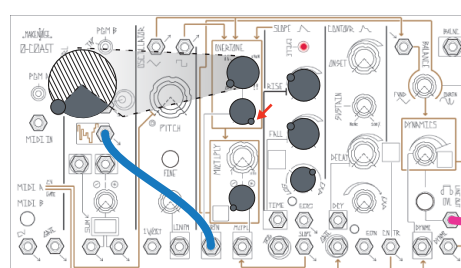

(remember, Slope is normalled to control Multiply). Remember, you can patch any output to any input. We'll briefly describe all the outputs and inputs in this manual, but even the most thorough description will not cover all of the patch connections that are possible.

This section contains short descriptions and examples for all the connections that are not part of the gold wire signal flow of the 0-Coast. Connecting cables to these patch points has the potential to expand the capabilities of the 0-Coast, without changing anything about its default operation. In the next section we will discuss patch points that override normalizations and have the capability to change the entire voice structure of the 0-Coast.

CTRL

Tempo Input: This input looks for a series of Gates, Clocks, and anything else with a hard edge. These clocks are combined with [TAPPING] of PGM_B and/or MIDI Clock, if Enabled.

Clock Output: A regular series of gates is output from this jack, the tempo of which is set by sending pulses to the Tempo jack, tapping the PGM_B button at the desired tempo, or MIDI Clock (Page 35 for information about MIDI options). Clock could be patched to, for example, the Trigger input on Slope, to create a time-synced series of functions.

Stepped Random Voltage Output A new random voltage is output from this jack with each cycle of the Clock (See Figure 63). Patch to 1V/Oct with Dynamics held open to hear its effects on oscillator pitch.

Voltage MATH: See Page 35

Oscillator:

Triangle Output: This output is the core of the Oscillator, has few overtones and is a classic building block for West-Coast synthesis. The output is hardwired to the input of the Overtone section, and also normaled to the Fundamental portion of the Balance control. Patching from this output does not remove it from Balance (to do that, patch a cable into the Balance input), but allows it to be patched elsewhere at the same time. For example, patch it to Multiply to hear the wave multiplier modulated very fast, at the rate of the Oscillator.

Square Output: This output is also derived from the Oscillator core. It has the same set of overtones as the Triangle, but the overtones appear at much greater amplitudes, which makes it a classic building block for subtractive (East-Coast) synthesis. Patch it to the Balance Signal Input and set balance Full CCW to hear it.

Lin FM Input: The typical use for Frequency Modulation is to super-impose the frequency of one oscillator upon another. The result is that the oscillator that is FM'd will carry the modulating oscillator's pitch information in the form of harmonics. Linear FM attempts to preserve the base frequency of the carrier oscillator, allowing for harmonically rich waveforms to be generated while still being able to track the musical scale properly. The Linear FM input is AC coupled and has a Level control. The 0-Coast has only one Oscillator, but when Slope is set to Cycle it can oscillate at audio-rate, becoming a great FM source. Patch Slope to Lin FM to hear this. Try starting with Rise and Fall at about 9:00, and Response set to Linear. As you increase the FM Index (using the LinFM input attenuator), the Amplitude of the signal Frequency Modulating the 0-Coast oscillator is increased and the resulting signals the Triangle, Square, Dynamic, and Line Outputs will become increasingly more complex. At greater than 80% Level, the Linear FM bus goes into overdrive and the 0-Coast will not track accurately. For extreme (exponential) FM, try patching Slope directly to the 1V/Oct input instead, Figure 33 .

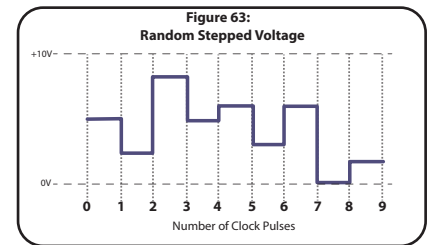
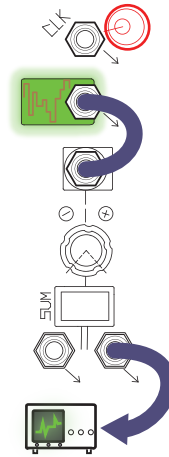

Frequency Modulation (FM):

Frequency Modulation is exactly what the name seems to describe: modulating the frequency, such as that of an oscillator, using a control voltage.

Technically, any such control is FM (patching a sequence to the 1V/Oct Input, for example). However, the phrase **FM Synthesis** usually refers to audio-rate FM, in other words using at least one audio-rate oscillator to modulate the frequency of another. This practice results not in a melodic sequence of pitches, but rather in a change in *timbre*.

More on FM:

The 0-Coast is laid out to make FM very fast to perform. There is a CV input labeled "LIN." Any signal patched modulates the VCO's frequency at a Depth set by the associated input Attenuator. For example, with Slope <Cycling>, patch Slope Output to the Linear FM input, causing the ear to hear the modulation as a difference in Timbre, rather than a Continuous Modulation of pitch, Figure 64. As the Attenuator is turned up, the Depth of Modulation gets higher and the timbral shift becomes more pronounced. At maximum, it is slightly overdriven which can actually start to warp the perceived pitch of the oscillator.

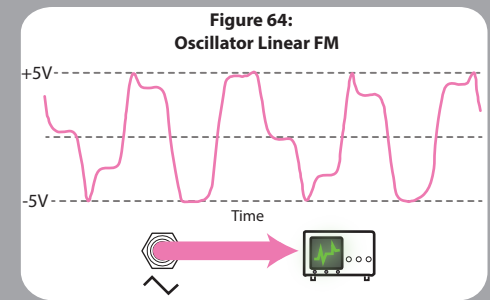

1V/Oct Input: The 1V/Octave Input is typically used for controlling the Pitch of the 0-Coast from a CV sequencer or CV Keyboard. It is also highly useful for sweeping the Frequency of the 0-Coast to animate percussion patches. If wild textures are desired, the 1V/Oct input could be used to implement Exponential FM. When using for modulation, consider patching the attenuverter from the Voltage Math section in series before the 1V/Oct input to adjust the FM Index. **Note: Any signal patched to the 1V/Oct input will be added to, or "summed with", the signal received there from MIDI A CV. Thus, if already controlling the 0-Coast pitch with MIDI, one could utilize the 1V/Oct input as a "transpose" control, or for modulation.**

Overtone CV Input: This input allows modulation of the harmonic created by the Overtone circuit using control voltage. A good example could be the patching of Contour to this input, which will result in a dynamic change in the timbre through the evolution of a Contour.

TIME: This input adjusts the time base of the Slope circuit. It equally affects both the Rise and Fall parameters. It is best demonstrated while Slope is Cycling. Set the Multiply input attenuverter and panel control so that the effect of Slope on the Multiply circuit can be easily heard. Now, patch Random to Time and listen as the speed of the Slope cycle is modulated randomly. Try changing the initial settings of Rise and Fall to hear the variety of modulation and how it sounds at slower and faster rates. For a variation, also patch EOC to Clock to sync the Random voltage to the Slope generator. This results in a new randomly selected Slope time with each Cycle.

TRIG: A Gate or Clock applied to this input will trigger the Slope circuit, the result being a 0V to 8V Slope Function, aka Envelope, whose characteristics are defined by the Rise, Fall, and Vari-Response parameters. This function rises from 0V to 8V and then immediately fall from 8V to 0V. There is no Sustain. To get a sustaining envelope function, use the Contour circuit. Patch Clock Output to this Input to Trigger a Slope function.

EOC (End of Cycle): This gate output is high whenever Slope is not in the Fall portion of a Slope function (**Figure 65, 2**). It can be used to generate a steady clock when Slope is set to Cycle or to initiate events elsewhere, such as, to generate a function by patching to Contour Gate Input that is used to modulate Overtone CV Input, or as a square or rectangular-shaped modulation source.

CONTOUR:

Decay: This input allows voltage control of the Decay parameter. For example, when playing or sequencing a series of notes, patch a slowly cycling Slope to the Decay input to cause the notes to ring out longer and shorter as the Slope travels "up and down".

EON (End of Onset): This Gate Output works the opposite of the Slope circuit's End of Cycle Output. Once a Gate is received at the Contour Gate Input, the End of Onset generates a Gate that goes High after the Onset portion of the Contour is finished and goes Low after the Decay portion is finished. It could be used to initiate events elsewhere, such as triggering a Slope by patching to the Slope Trigger Input.

Figure 65: Typ. Triggered Slope Function

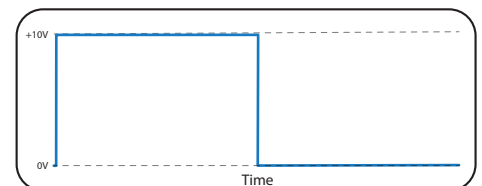
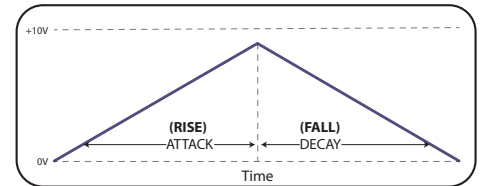
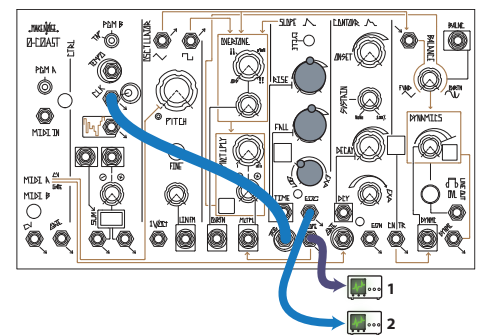

Attack Decay (AD): The Function is initiated once the Gate or Trigger is received at the Slope Trigger Input. Note: Gate Length is ignored, as only the Rising Edge is "seen" by the input.

BALANCE and DYNAMICS:

BALANCE CV: This input allows for the use of control voltage to modulate the Balance between Fundamental and Overtone that is sent to the Dynamics circuit. Try patching Contour Output to this Input and setting Balance Full CW. The input is normalised to a voltage offset so that the Balance Combo Pot can be used as panel control when no CV is applied. As soon as you patch a cable to the Balance CV input, the Combo Pot becomes an attenuator for the incoming control voltage.

DYNAMICS Output: This output contains the same signal as the Line Output, but at full amplitude for connection to modular synthesizers or back into an input of the 0-Coast for feedback. It is NOT recommended to patch this output to line level equipment, or to headphones.

Overriding Normals:

The "Open Connections" section showed the many places in which it is possible to expand your use of the 0-Coast without changing anything about its Normal operation. In this section we will show patch connections with the potential to override that operation entirely.

The 0-Coast utilizes switching jacks on some of its inputs and outputs. These jacks have the capability of receiving two different signals depending on whether a patch cable is physically present. Plug in a cable into a jack with a normalization bypasses said signal and replaces it with whatever you patch in.

Here is a list of the normalised connections within the 0-Coast that may be removed by patching to the associated jack:

Multiply CV Input: Multiply is controlled by Slope in normal operation. Try taking MIDI B CV patched to this input set to C3 to accomplish something similar to "Keyboard tracking" found on subtractive monosynths in the "East-Coast" paradigm.

Contour GATE Input: The Contour circuit is normally engaged by the Gate from MIDI A. Try patching a different clock or gate source, such as the Clock output while still using MIDI to control pitch.

BALANCE Input: Normally, we set the Balance between the Fundamental Triangle Core and Overtone circuits. Using this input we could replace the Triangle with the Square wave, or even with audio from a source outside the 0-Coast.

DYNAMIC Input: The Dynamics circuit is normally controlled by the Contour generator. Patching an Offset results in a Drone, as we have used to demonstrate concepts throughout the manual. Other potential sources include the Slope generator, Clock Output, EON, EOC, Stepped Random, and more.

Patching into a jack to override a normalization does a lot to open up the signal flow possibilities in the 0-Coast. The concepts already outlined can get you very far, but as you continue patching, some questions will eventually start to arise: What if you want to control a parameter with two sources at once? What if you want to send the same modulation source to more than one destination? What if you want to control a positive-only parameter like Overtone with a negative version of a positive-only signal like Contour?

The Voltage MATH, located below the Clock and Random circuits, is a small, powerful, open-ended circuit that provides the answers to questions like these. It gives a small taste of the sorts of Control Processing that can be done in our modular systems using modules like MATHS. The concepts of SUM, Difference, Offset, Inversion, Attenuation, Amplification, and Multing are all represented here.

The short and technical way to describe the Voltage MATH is:

- The two signal Inputs are Summed, and the result appears at each of the signal Outputs.
- The right-hand signal input is normalled to an Offset and is equipped with an Attenuverter.

If that reads more like science than music, here is a slower, less technical description with examples: the two inputs at the top are mixed (Summed) together. The result appears identically at both outputs at the bottom. The left input, Channel 1, is always at "Unity" (there is no control over its Level or polarity), while the right input, Channel 2, is further processed by an attenuverter. (See Page 20)

An example of the use of mixing, or Summing, the two inputs, would be randomizing the start point of modulation of the Multiply circuit by the Slope circuit. To do this, patch Slope to the left input, Random to the right input, and either of the Control Processor outputs to Multiply CV Input .Set the Control Processor's right input attenuverter to 12:00. Set Multiply full counterclockwise and the Multiply CV Input attenuverter to about 3:00. You should hear the familiar sound of the Multiply circuit being modulated by Slope (remember to have Balance set far enough clockwise that the Overtone circuit is audible). Gradually, turn the Control Processor's input Attenuverter clockwise to hear Random voltage added to the Slope's output. You could also try syncing this Random voltage to the Slope generator by patching the EOC output to the Tempo input, which will cause a new Random value with each Cycle of the Slope.

FIGURE 66: Voltage MATHS

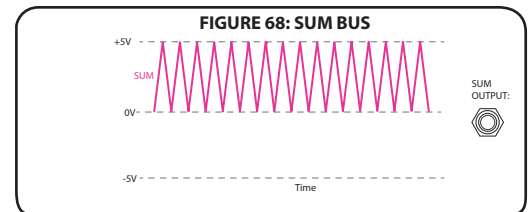
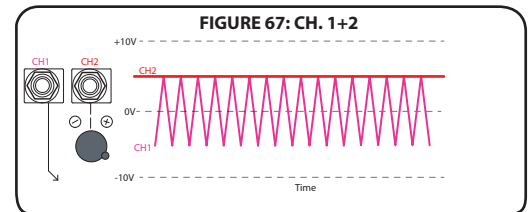
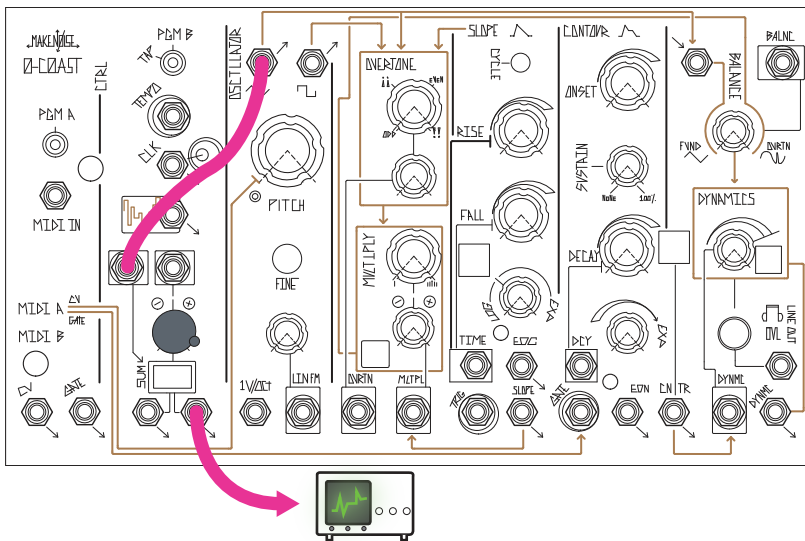

SUM OUT: The SUM Output is a voltage mixer, allowing for the easily addition or subtraction of two signals of any type. With nothing patched to CH.2, the Panel Control generates an Offset Voltage.

The 0-Coast's signal inputs and outputs fit the standard of the Eurorack modular synthesizer created by Doepfer. For details of this format visit http://www.doepfer.de/home_e.htm

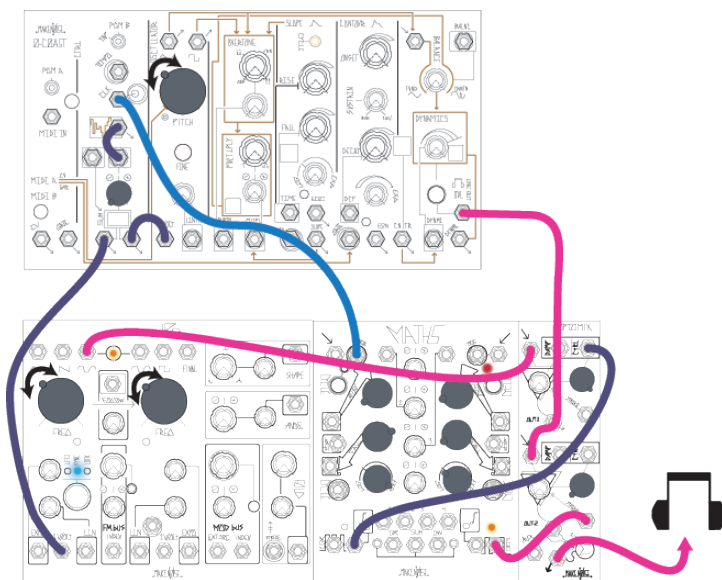
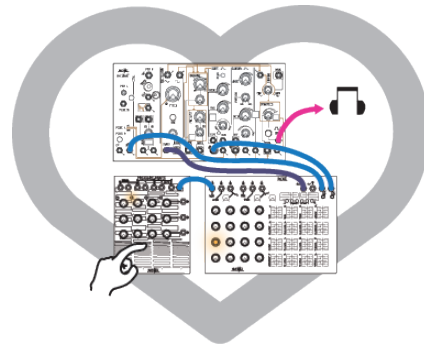

Figure: 69
Any CV or Gate signal conforming to these signal levels may be used to control the 0-Coast, and vice versa.

EXAMPLES: Sequence the 0-Coast with René or Korg/Arturia sequencers, process the 0-Coast's Dynamic output in the Make Noise System 0.

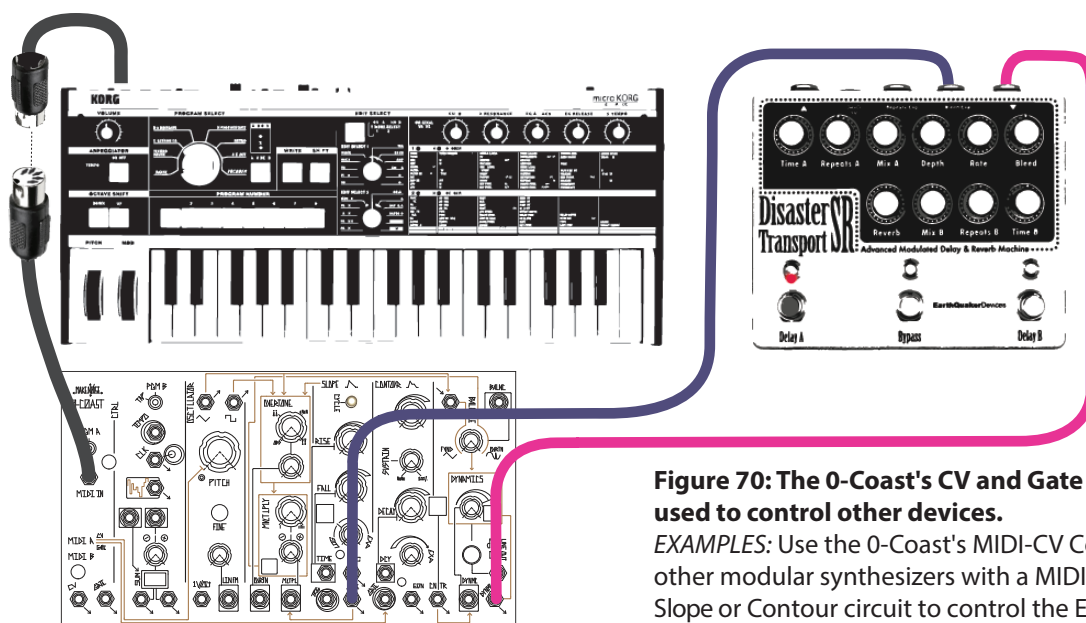
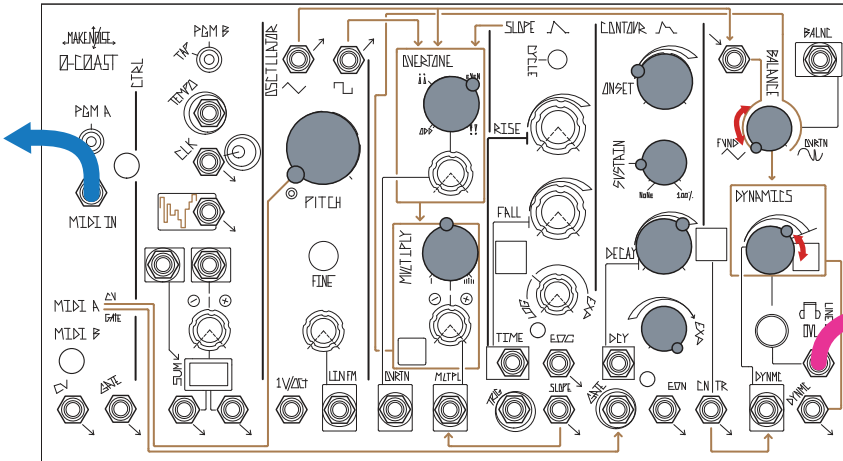

Figure 70: The 0-Coast's CV and Gate Outputs may be used to control other devices.

EXAMPLES: Use the 0-Coast's MIDI-CV Converter to play other modular synthesizers with a MIDI keyboard, use the Slope or Contour circuit to control the Expression input on a stompbox from Moog or Earthquaker Devices.



Simple Bass with Brightness (Tony Rolando)

Adjust Balance Clockwise up to 11 o' Clock for Brighter sound

Adjust Dynamic from 2:00, up to 5:00 for more aggressive sound.

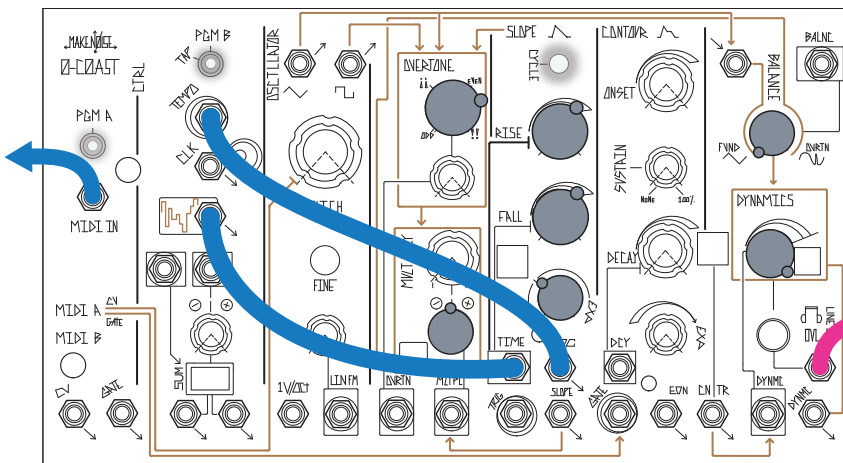

Fluttering Arpeggios (Tony Rolando)

Slope Cycle ON

Set rest of 0-COAST to sound how you like, for example you could use the Simple Bass w/ Brightness as a starting point for your sound.

Turn on Arp by PRESS PGM_A and PGM_B

Play Arp how you like.

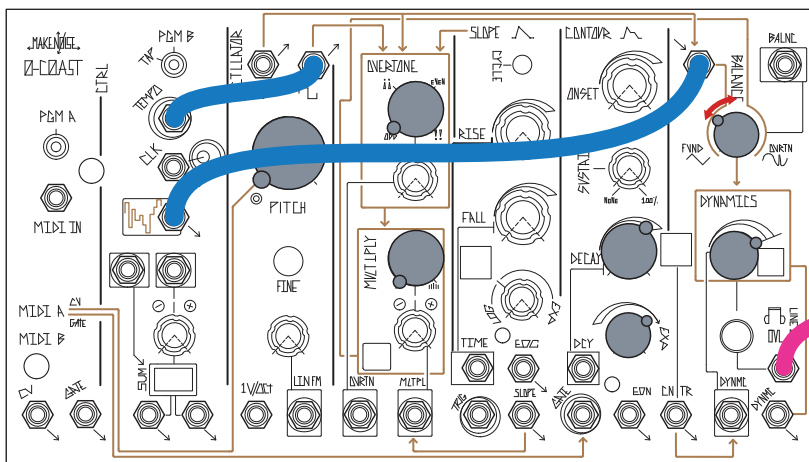

Low Harmonic Synth with Noisy Octave Down (Tony Rolando)

Adjust Balance to taste, between 10 o' clock to 12:00.

Play using same method as Default Patch with MIDI or 1V/ Octave CV Input and Contour Gate Input



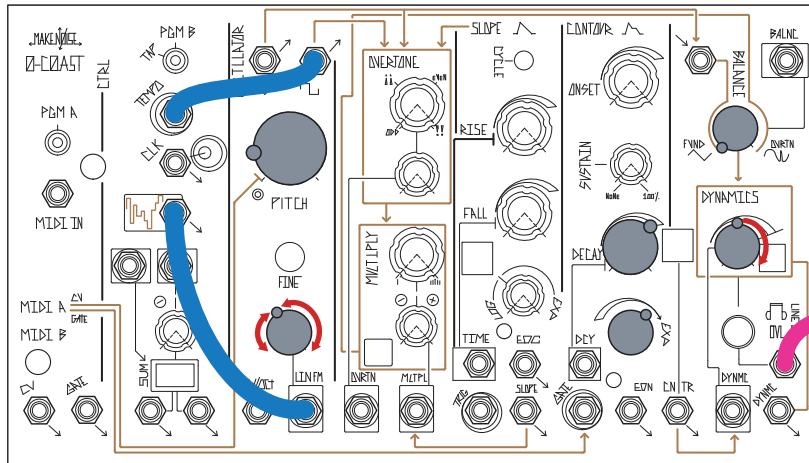

Pitched Noise Orbit (Tony Rolando)
Adjusting Linear FM Attenuator from Full CCW to Full CW sets the depth of the Noise.

At Full CCW, you have a simple, low harmonic tone. As you set the Linear FM control to be more Clockwise the tone becomes orbited by noise until finally at Full CW, the sound is only noise.

Set Dynamics at 12:00 and adjust from CW up to Full CW for a brighter, more aggressive tone.

Play using same method as default patch with MIDI or 1V/Octave CV Input and Contour Gate.

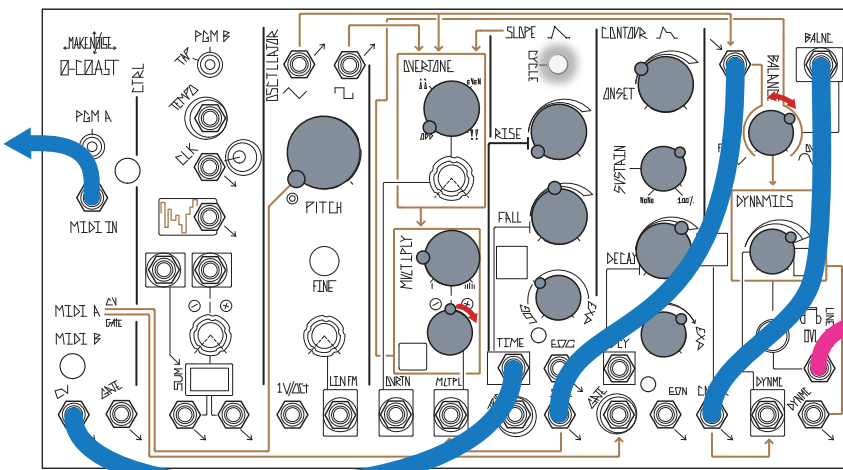

East Coast Bass (Tony Rolando)
Requires user to calibrate Cycling Slope circuit. See Page 14 "7. Calibrate: MIDI_A & MIDI_B."

Play using same method as default patch with MIDI or 1V/Octave CV Input and Contour Gate.

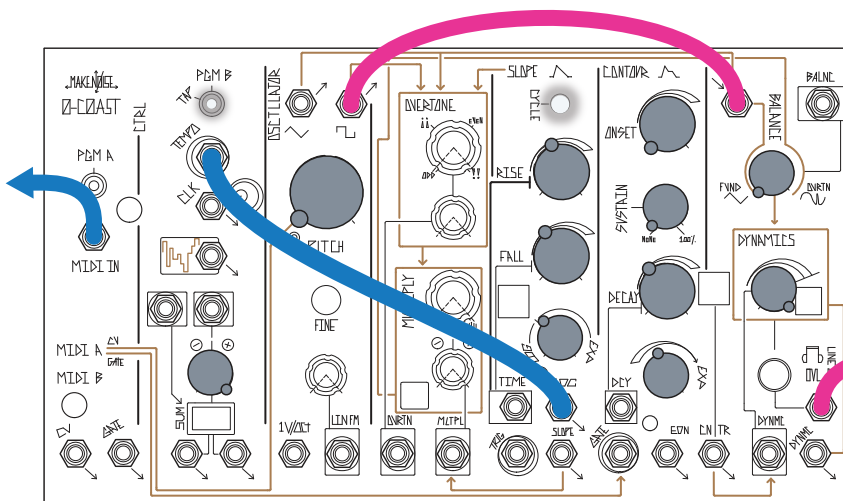

Arcade Trills (Walker Farrell)
Turn Arpeggiator ON and play chords. Adjust Slope controls to taste.

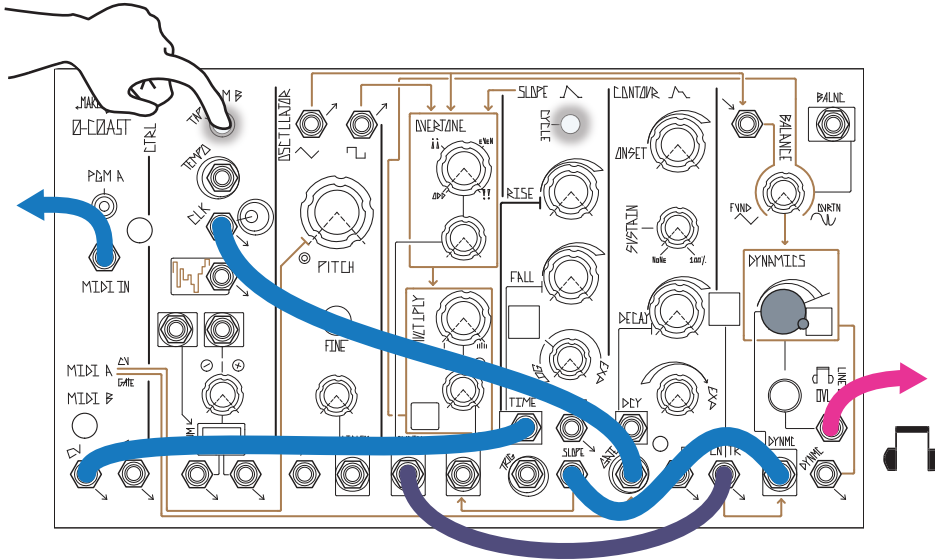

Wobble Bass (Walker Farrell)

Uses Slope for amplitude control and Contour for slower timbral control on Overtone. Wobble speed follows pitch (set MIDI B CV to NOTE). Adjust Rise to fit desired pitch range.

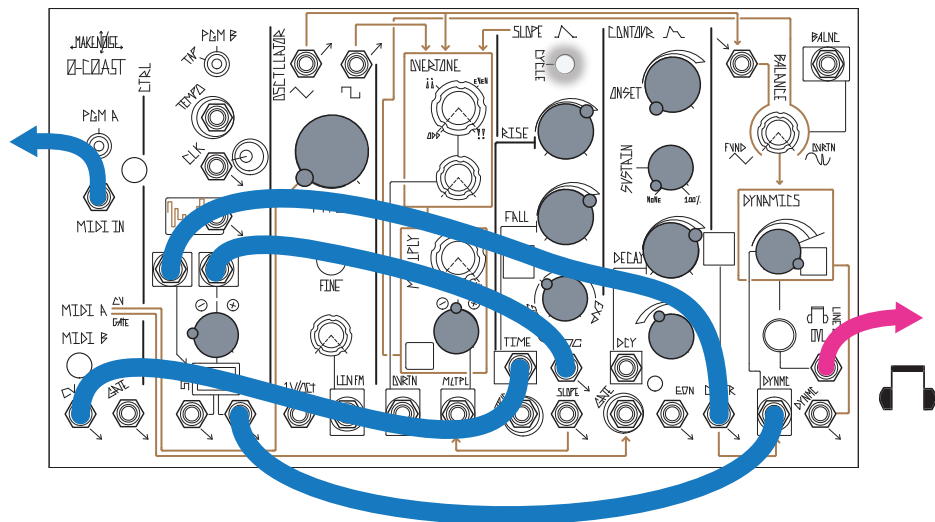

Key Controlled Echo (Walker Farrell)

Echo time follows pitch (set MIDI B CV to Note).

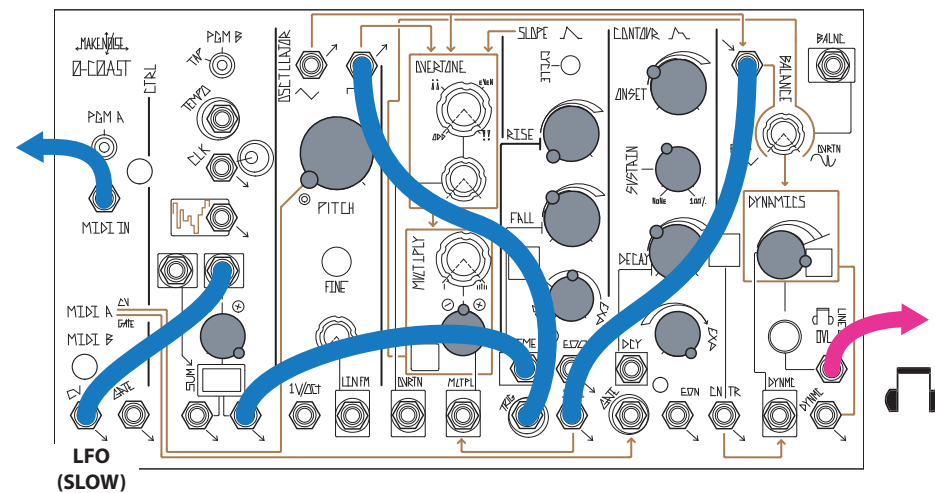

Sync Bass (Walker Farrell)

Uses Slope as a sawtooth VCO, synced to the Oscillator. Set MIDI B CV to LFO, and <tap> a very slow tempo on PGM_A. Adjust Slope controls to taste. Will sound best in low registers.

LFO (SLOW)

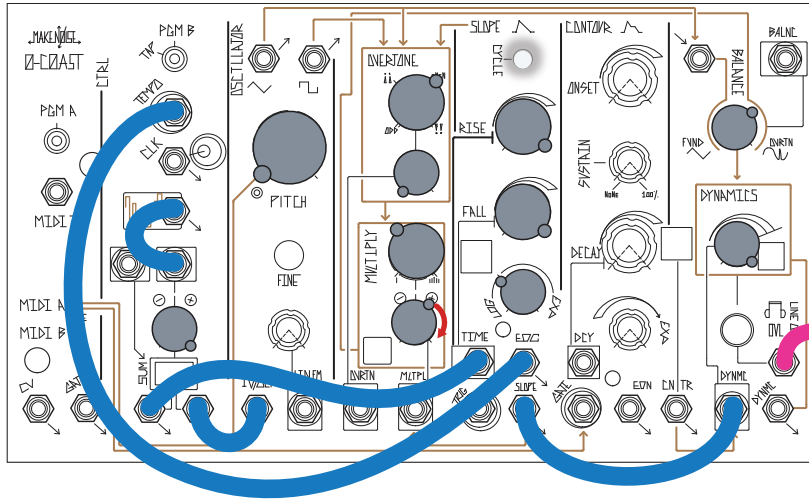

Krell (Walker Farrell)

Reverb strongly recommended

Clear MIDI data by holding PGM_B. Set Voltage Math attenuverter to taste on positive side (start with 3:00). This patch is self-playing. Thanks Todd Barton.

Variation: set Oscillator Pitch full CW, Rise and Fall to 10:00, Voltage Math Attenuverter 9:00.

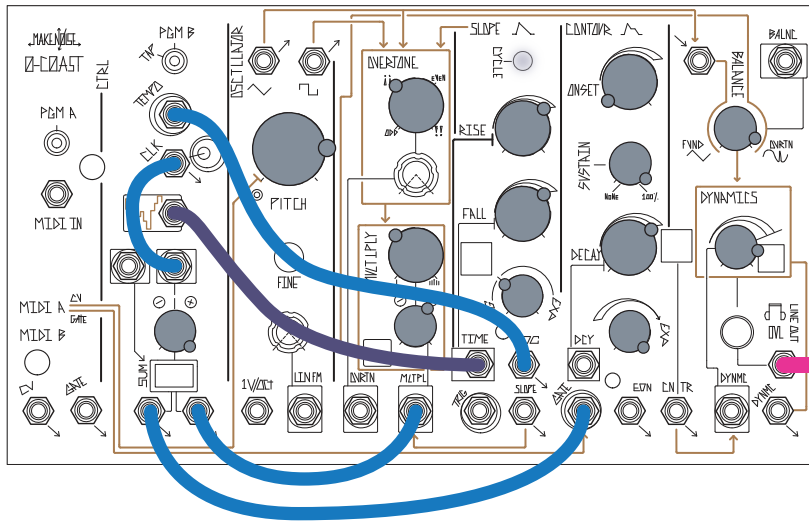

Telegraph (Walker Farrell)

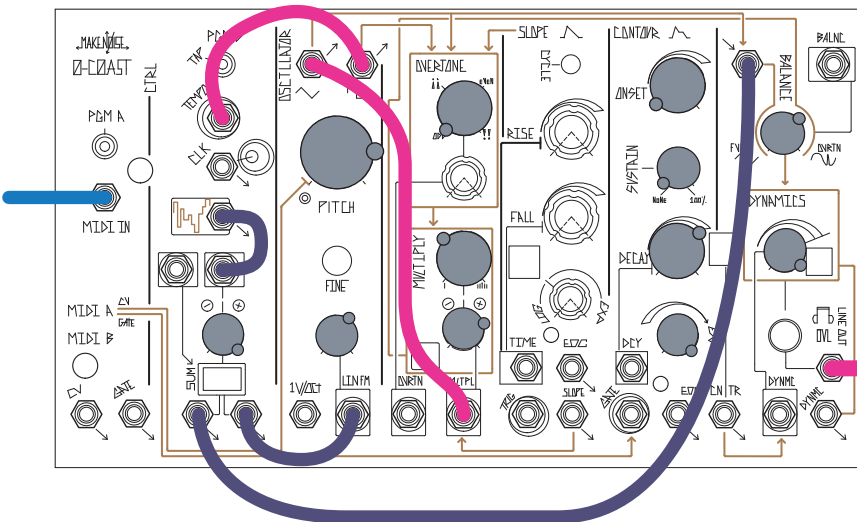

Snare (Walker Farrell)

“Interface”

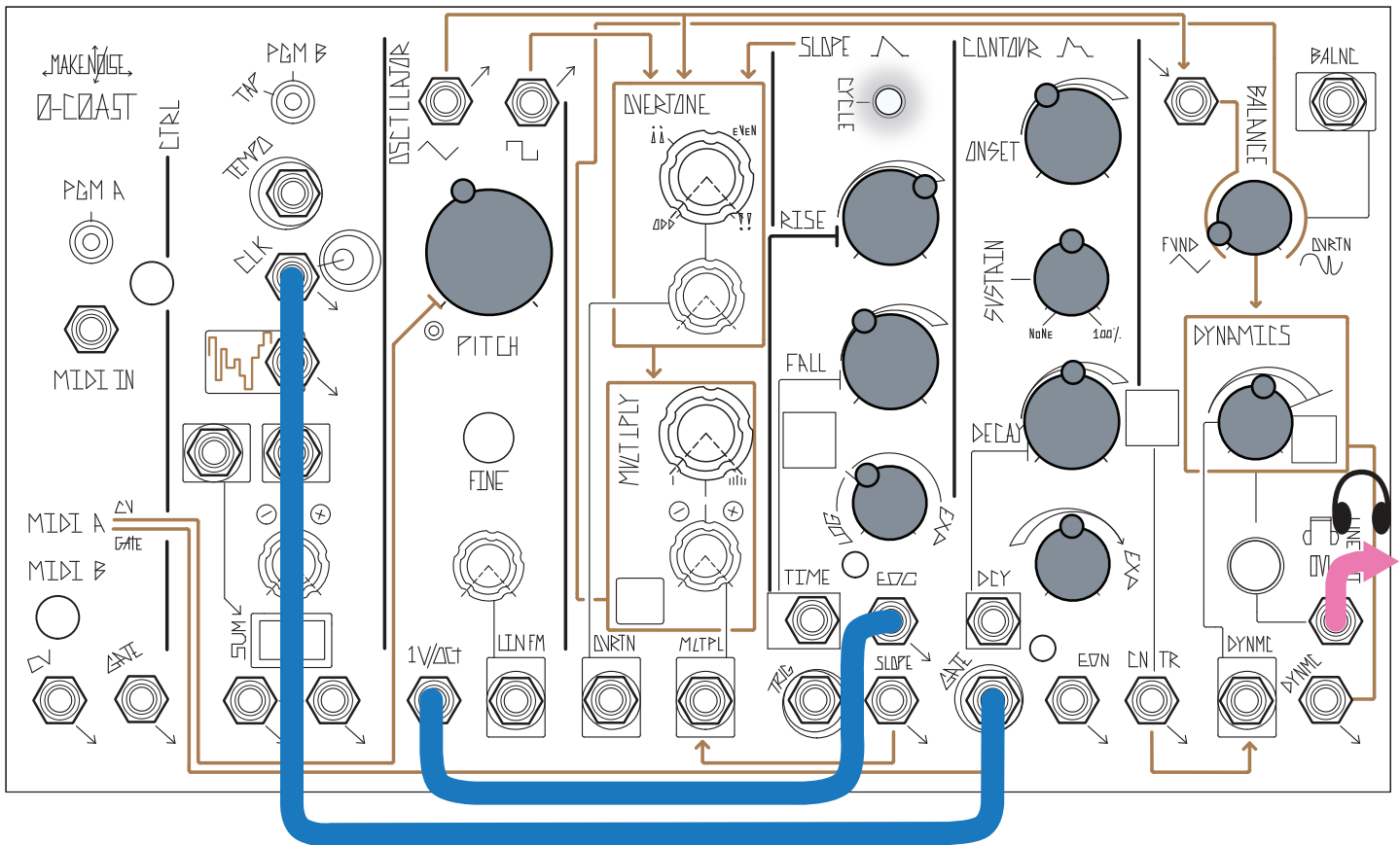

Natural Water Drop

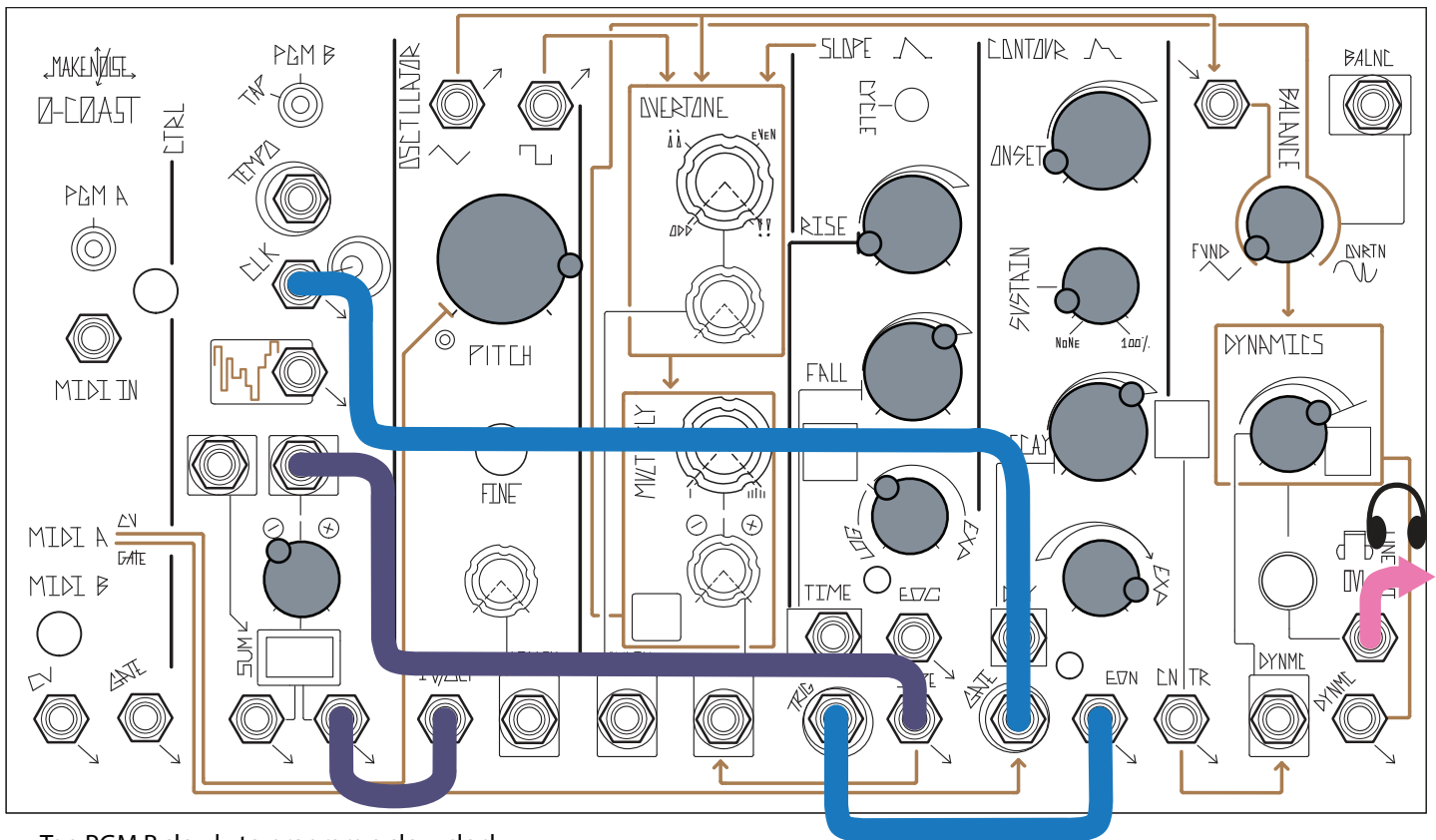

Tap PGM B slowly to program a slow clock.

"Transform"

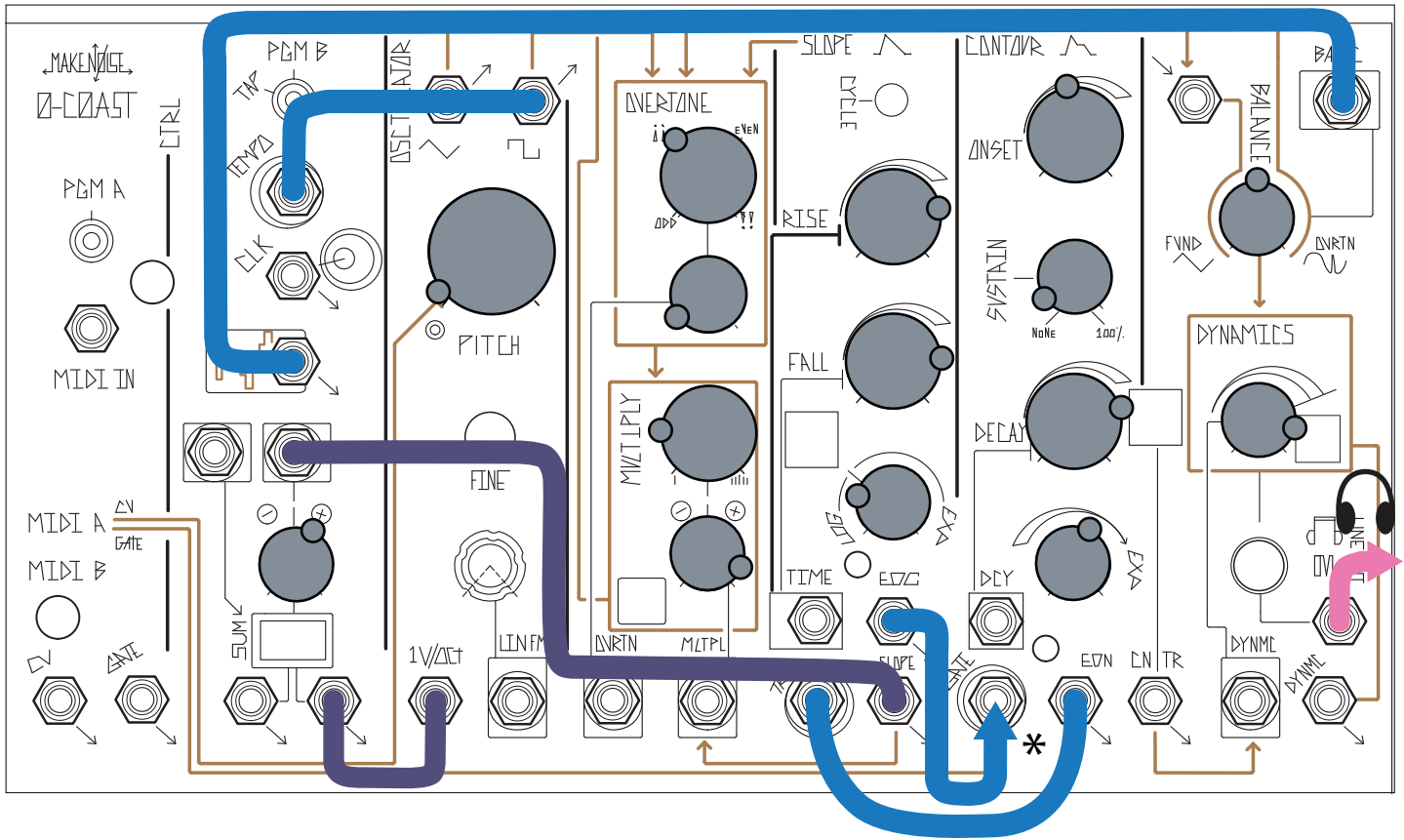

"Impact"

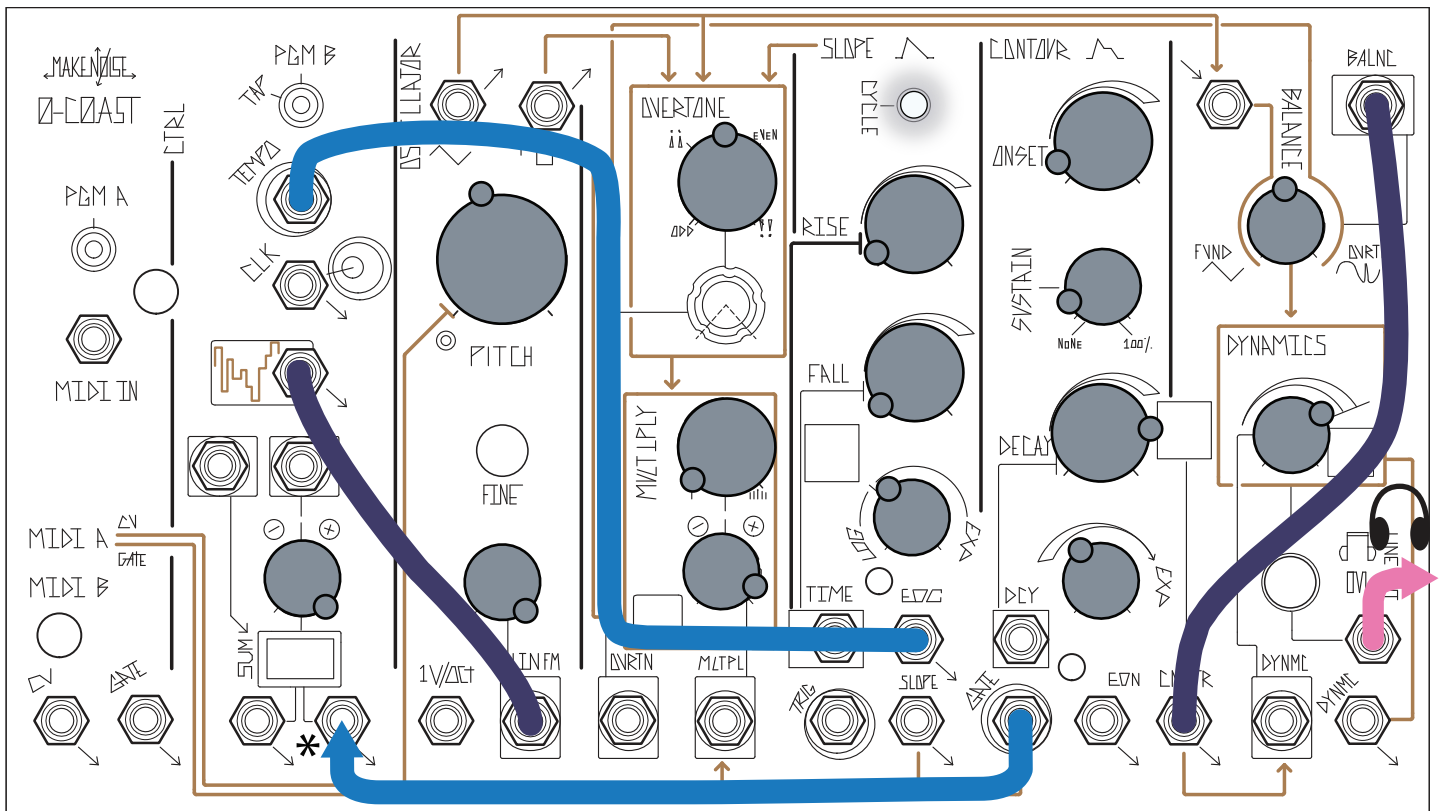

*Momentary Connection

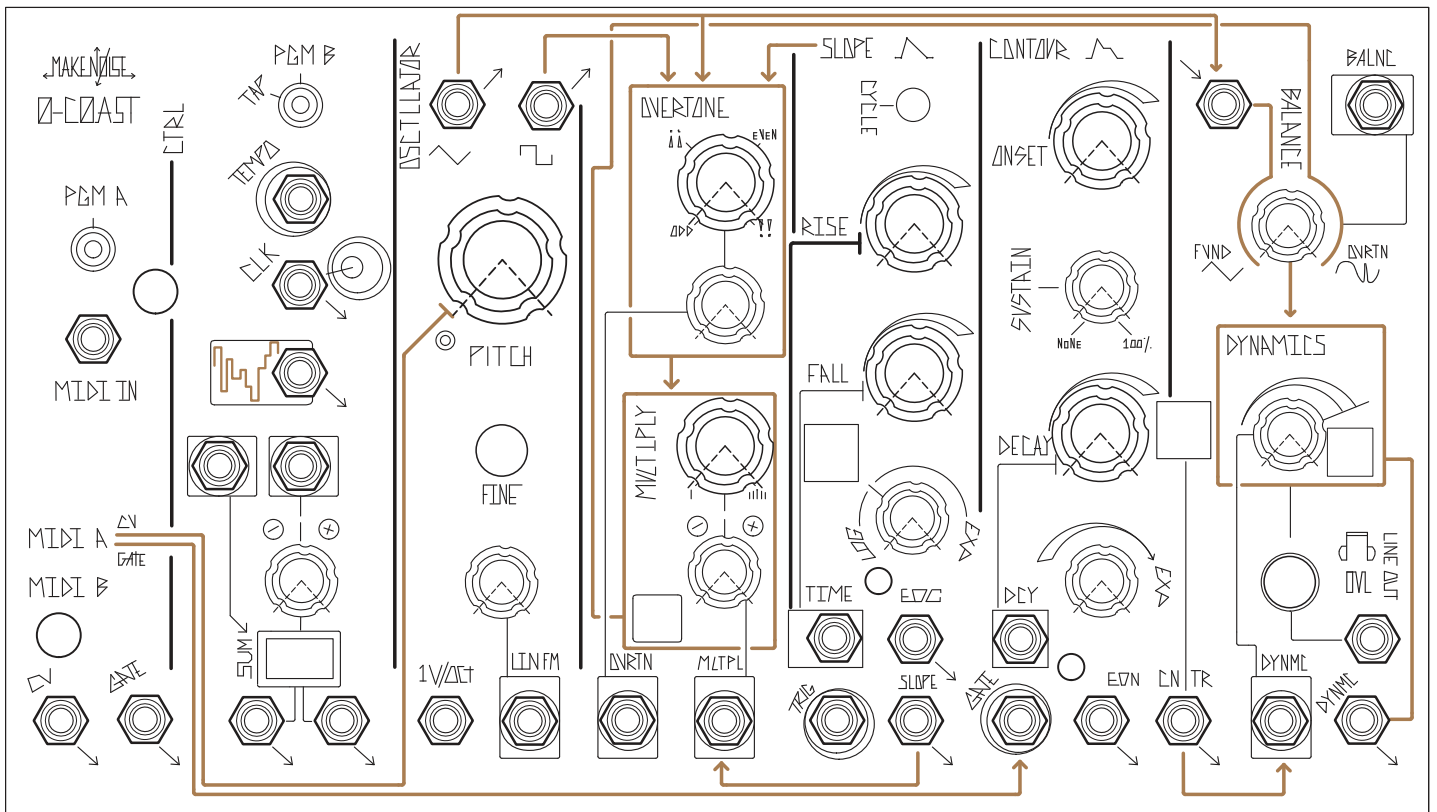
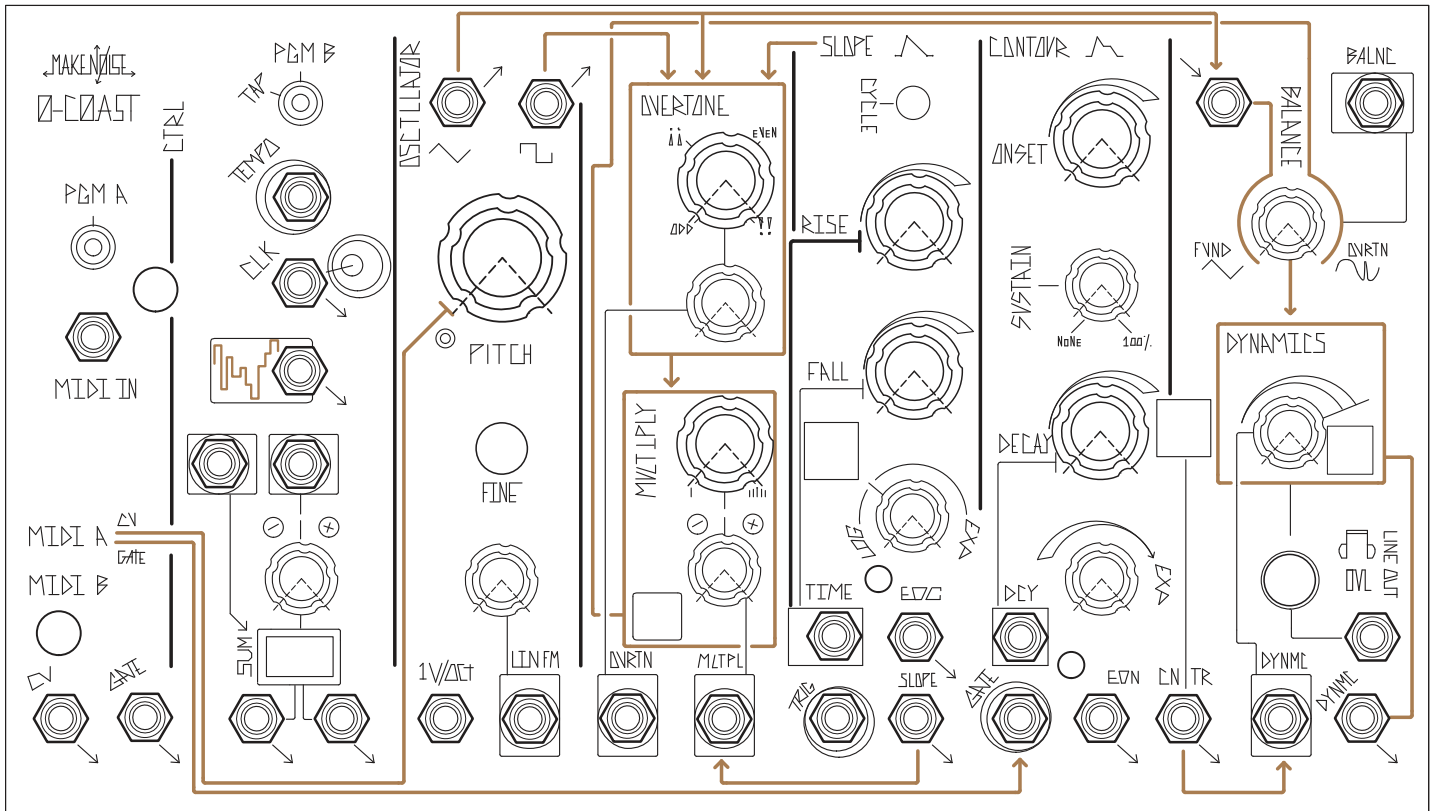

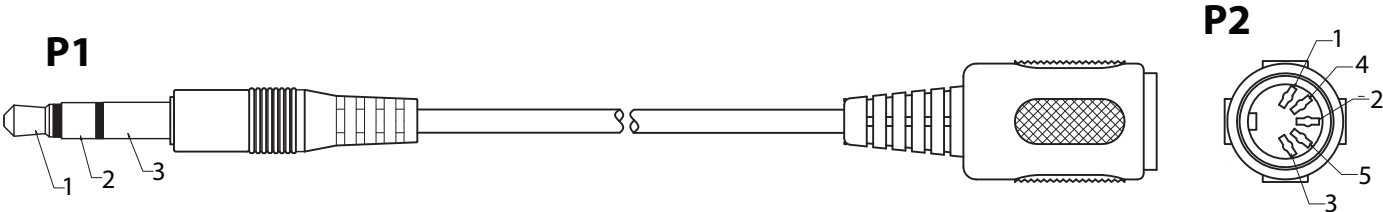

Pin Out:

P1	P2
1-----	5
2-----	4
3-----	2